

SURGICAL INSTRUMENTS CATALOG

German Engineering. American Design. World-Class Quality.



GENERAL INFORMATION

Pilling® and KMedic® Surgical Instruments	7
Customer Service	8
Guarantee/Warranty	9
Care and Cleaning	10
Policies and Procedures	11
Trademarks	12
Instrumentation Services	13
N-Compass™ Instrument Management System	14
Scales and Gauges	16
Measuring Guidelines and Common Jaw Patterns of Surgical Instruments	18

GENERAL INSTRUMENTS AND PRODUCTS

Overview	20
Knife Handles	22
Forceps and Clamps	25
Scissors	101
Needle Holders	150
Retractors, Hand-Held	185
Retractors, Self-Retaining	216
Retractors, Table-Mounted	238
Suction Tubes	243
Extended Length/Open Bariatric	249
OB/GYN	262
Urology	292
Rectal	298
Miscellaneous General	307
Micro Clips and Applicators	315
Instrument Accessories	322
Floor Grade Instruments	349
Specialty Sponges	357
Weck® Specialty Products	367
Container Systems	368
Weck® Ligation Solutions	373

EAR, NOSE AND THROAT INSTRUMENTS

Overview	386
Laryngoscopes	388
Subglottiscopes	406
Instrumentation for Laryngoscopes	416
Bronchoscopes	437
Telescopes and Accessories	442
Rigid Endoscope/Telescope Compatibility Chart	444
Esophagoscopes	446
Instrumentation for Bronchoscopes and Esophagoscopes	451
Fiber Optic Cables	463





GENERAL INSTRUMENTS

Pilling® Surgical Innovation and Quality

CHAPTER OVERVIEW

It has been the innovations developed through the Pilling® Brand and responsiveness to the needs of healthcare professionals which have established Teleflex® as a leader in surgical instrumentation.

Today, in addition to the worldwide recognition for excellence achieved in the area of Cardiovascular, Thoracic and Ear/Nose/Throat surgical instrumentation, Teleflex® also provides a full range of Pilling General Instrumentation manufactured to our traditionally high standards of quality and value.

PRODUCTS

Our extensive line of Pilling® General Instruments are made from German stainless steel and include the following:

- Scissors
- Needle Holders
- Hemostats
- Dressing, Sponge and Tissue Forceps
- Knife Handles
- Hand-Held, Self-Retaining Retractors
- Suction Tubes
- Extended-Length Instruments
- Trays
- And many more

FEATURED PRODUCT

Pilling® CircuTract Retracting System

- Maximum exposure for optimal visibility
- Compatible with all Bookwalter® Retractor Components
- Full complement of bariatric components
- Easy assembly

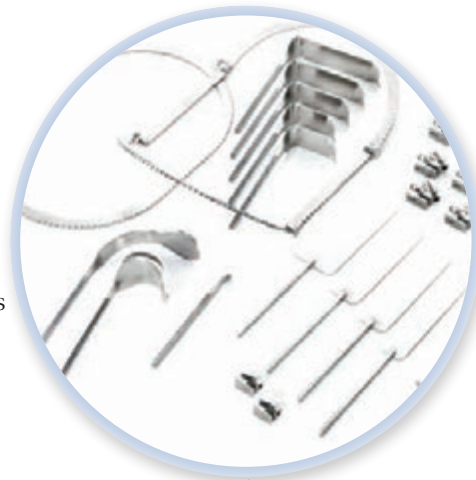

Bookwalter is a registered trademark of Specialty Surgical Instrumentation Inc.

KNIFE HANDLES

General

KNIFE HANDLES



352950



352951



352952



352953



352954



352957



352959

Correctly fit knife handle to standard surgical blades. The distal ends are tapered and beveled for use in blunt dissection. Each handle is contoured for firm grip, strength, manipulation and comfort. They are sold one handle each per package.

ITEM #	DESCRIPTION
352950	Size 3, fits blade sizes 10, 11, 12 and 15
352951	Size 3L, fits blade sizes 10, 11, 12 and 15. Measures 8-3/8" (21.5 cm) not including blade.
352952	Size 3LA, fits blade sizes 10, 11, 12 and 15
352953	Size 4, fits blade sizes 20, 21, 22, 23, 24 and 25
352954	Size 4, fits blade sizes 20, 21, 22, 23, 24 and 25. Measures 8-3/8" (21.5 cm) not including blade.
352957	Size 7, fits blade sizes 10, 11, 12 and 15
352959	Size 9, fits blade sizes 10, 11, 12 and 15

KNIFE HANDLES

General

ROUND SHAFT BEAVER BLADE HANDLES



ITEM #	DESCRIPTION
456002	Replacement collet
456005	#3KM, 2-31/32" (7.5 cm)
456006	#3K, 4-1/8" (10.5 cm)
456007	#3KL, 6" (15 cm)

Specialty

WEBSTER SKIN GRAFT KNIFE HANDLE



Use with blade no. 450205, 7-3/8" (18.5 cm).

ITEM #	DESCRIPTION
050230	Handle only

GOULIAN SKIN GRAFT KNIFE SET



Includes: 1 handle 7-1/4" (18.5 cm), 5 single edge blades 2-1/4" (5.5 cm), 3 depth gauges and guards: 008, 010, 012.

ITEM #	DESCRIPTION
050200	Complete

KNIFE HANDLES

Specialty

GOULIAN DEPTH GAUGE AND GUARDS



050203

2-3/8" (6 cm).

ITEM #	DESCRIPTION
050201	0.004"
050202	0.006"
050203	0.008"
050204	0.010"
050205	0.012"
050206	0.014"
050207	0.016"
050208	0.018"
050209	0.020"
050211	0.024"
050212	0.026"
050213	0.028"

WECPREP BLADES



450205

Single edge carbon steel blade. Use with 050200 and 050230.

ITEM #	DESCRIPTION
450205	2-1/4" (5.5 cm), carton of 50

HOLINGER LARYNGEAL KNIFE HANDLE



506705

For use with surgical blades no. 10, 11, 12 and 15.

ITEM #	DESCRIPTION
506705	11" (28 cm)

FORCEPS AND CLAMPS

Sponge Forceps

BALLENGER SPONGE FORCEPS

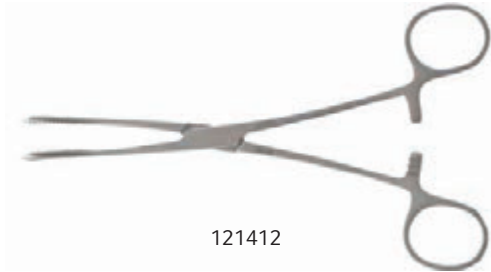

121412

ITEM #	DESCRIPTION
121410	Straight, smooth jaws, 7-1/4" (18.5 cm)
121412	Straight, serrated jaws, 7-1/4" (18.5 cm)
121422	Curved, serrated jaws, 7" (18 cm)

FOERSTER SPONGE FORCEPS



121417

Pilling® Pattern, satin finish.

ITEM #	DESCRIPTION
121415	Straight, smooth jaws, 9-3/4" (25 cm)
121417	Straight, serrated jaws, 9-3/4" (25 cm)
121425	Curved, smooth jaws, 9-1/2" (24 cm)
121427	Curved, serrated jaws, 9-1/2" (24 cm)

FOERSTER SPONGE FORCEPS

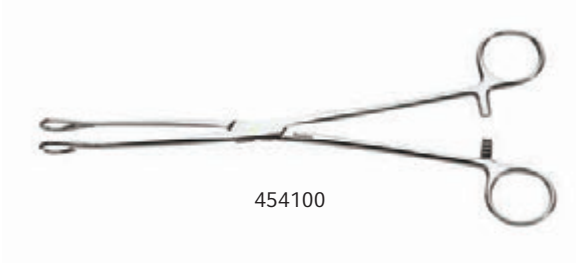

454100

Weck® Pattern, bright finish.

ITEM #	DESCRIPTION
454100	Straight, cross serrated jaws, 9-1/2" (24 cm)

FORCEPS AND CLAMPS

Tubing Clamps

GUNNAR ROLLER CLAMPS

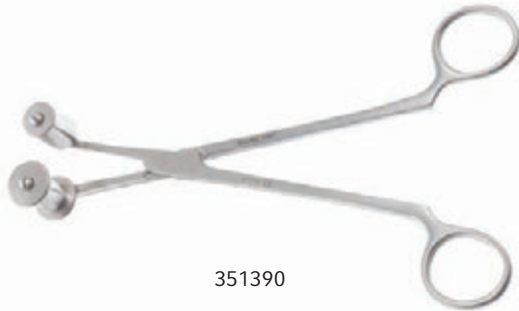

351390

ITEM #	DESCRIPTION
351390	For "milking" pump tubing 1/2" (12.5 mm) diameter, 7-1/8" (18 cm)

LORE TUBE HOLDING FORCEPS



536275

Full serrations, serrated jaws grasp drape without puncturing. Fitting on shanks holds tubing securely and without drag when not in use. Suction tube may be stored in protective metal sleeve.

ITEM #	DESCRIPTION
536275	Angled, 2.6 mm tip, 6-1/4" (16 cm)

MORSE TOWEL CLIP TUBING HOLDERS



351353

For holding extracorporeal tubing to drapes giving positive fixation. The serrated inner surface of the tube holding ring closes down on the tubing but does not collapse or reduce the lumen. Sizes listed are for outside diameter of extracorporeal tubing.

ITEM #	DESCRIPTION
351351	For 3/16" and 1/4" tubing
351352	For 5/16" and 3/8" tubing
351353	For 7/16" and 1/2" tubing
351354	For 9/16" and 5/8" tubing
351355	For 11/16" and 3/4" tubing

FORCEPS AND CLAMPS

Tubing Clamps

NICHOLS TUBING HOLDER



351370

Specially designed to hold and support the weight of the various diameters of tubing used by the pump-oxygenator, keeping them "in-line."

ITEM #	DESCRIPTION
351370	4-1/2" x 7-1/4" (11.4 x 18.5 cm) metal plate is perforated so it may be held in place with towel clamps.

PRESBYTERIAN HOSPITAL TUBING CLAMP

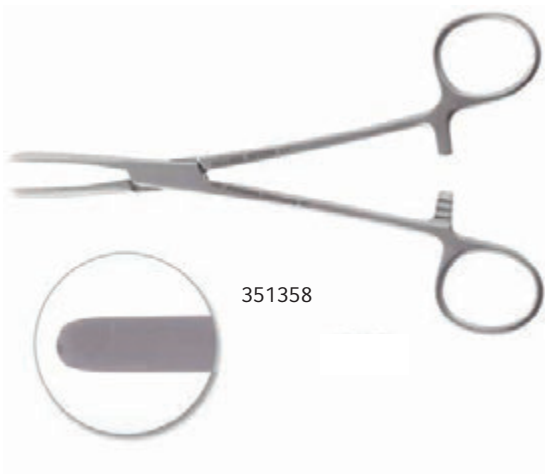

351358

Durable construction with smooth jaws for clamping off tubing without damage.

ITEM #	DESCRIPTION
351358	6-1/2" (16.5 cm)

FORCEPS AND CLAMPS

Tubing Clamps

VORSE TUBING OCCLUDING CLAMPS



Heavy construction with jaws designed for positive occlusion of Silastic®, Tygon® and similar thick-walled tubings.

ITEM #	DESCRIPTION
351373	For tubing 1/4" I.D. (3/8" O.D.), 6-1/8" (15.5 cm)
351374	For tubing 3/8" I.D. (5/8" O.D.), 7-3/8" (18.5 cm)
351375	For tubing 1/2" I.D. (3/8" O.D.), 8-1/8" (20.5 cm)

VORSE TUBING OCCLUDING CLAMPS WITH SAFETY GUARD



The familiar Vorse-type tube-occluding clamp supplied with a safety guard to prevent the box lock from puncturing the tubing. Heavy construction with jaw designed for positive non-slip occlusion of Silastic®, Tygon® and similar thick-walled tubing.

ITEM #	DESCRIPTION
351376	For tubing 1/4" I.D. (3/8" O.D.), 6-1/8" (15.5 cm)
351377	For tubing 3/8" I.D. (5/8" O.D.), 7-3/8" (18.5 cm)
351378	For tubing 1/2" I.D. (3/8" O.D.), 8-1/8" (20.5 cm)

FORCEPS AND CLAMPS

Towel Clamps

EDNA TOWEL FORCEPS



Pilling® Pattern, satin finish.

ITEM #	DESCRIPTION
121655	Single row of non-penetrating teeth, 5-1/2" (14 cm)
121656	4" (10 cm)

EDNA NON-PERFORATING TOWEL CLAMPS



Weck® Pattern, bright finish.

ITEM #	DESCRIPTION
454320	3-3/4" (9.5 cm)
454322	5-3/8" (13.5 cm)

FORCEPS AND CLAMPS

Towel Clamps

BACKHAUS TOWEL CLAMPS



Weck® Pattern, bright finish.

ITEM #	DESCRIPTION
454300	3-1/2" (9 cm)
454305	5-1/4" (13.5 cm)

BACKHAUS TOWEL FORCEPS



Pilling® Pattern, satin finish.

ITEM #	DESCRIPTION
121605	3-1/2" (9 cm)
121600	5-1/4" (13.5 cm)

BACKHAUS TOWEL FORCEPS EBONIZED

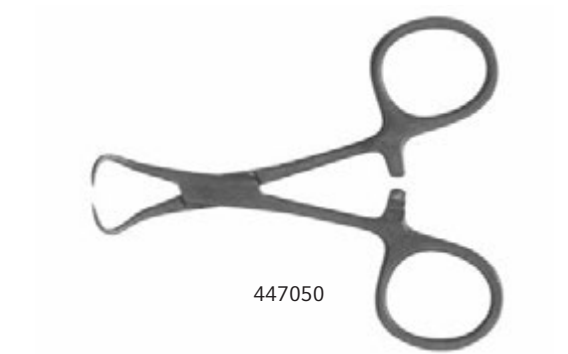

Ebonized for laser surgery.

ITEM #	DESCRIPTION
447050	3-1/2" (9 cm)

FORCEPS AND CLAMPS

Towel Forceps

JONES CROSS-ACTION TOWEL FORCEPS



121640

ITEM #	DESCRIPTION
121640	3-1/2" (9 cm)

PEERS TOWEL FORCEPS



121650

Double opposing row of non-penetrating teeth.

ITEM #	DESCRIPTION
121650	5-3/4" (14.5 cm)

ROEDER TOWEL FORCEPS

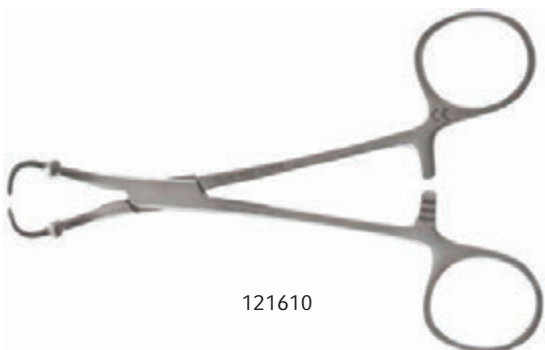

121610

ITEM #	DESCRIPTION
121610	With ball stops, 5-1/4" (13.5 cm)

FORCEPS AND CLAMPS

Splinter Forceps

CARMALT SPLINTER FORCEPS



ITEM #	DESCRIPTION
KM39410	Straight, serrated, 4-3/8" (11 cm)
KM39412	Curved, serrated, 4-3/8" (11 cm)

FEILCHENFELD SPLINTER FORCEPS



ITEM #	DESCRIPTION
KM39386	Straight, serrated, 3-1/4" (8.5 cm)
KM39390	Straight, serrated, 4-1/2" (11.5 cm)

PLAIN SPLINTER FORCEPS



ITEM #	DESCRIPTION
KM39364	Straight, serrated, 3-1/2" (9 cm)
KM39366	Straight, serrated, 0.6 mm tip, 4-1/2" (11.5 cm)

SPLINTER FORCEPS



ITEM #	DESCRIPTION
181556	Straight, serrated, 3-1/8" (8 cm)
181557	Straight, serrated, 4" (10 cm)
181559	Straight, serrated, 5" (12.5 cm)



FORCEPS AND CLAMPS

Splinter Forceps

VANGUARD SPLINTER LIBERATOR

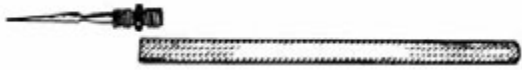

KM39534

ITEM #	DESCRIPTION
KM39534	Trocar in reversible handle, 5" (12.5 cm)
KM39536	Trocar point only

VIRTUS SPLINTER FORCEPS



KM39478

ITEM #	DESCRIPTION
KM39478	Straight, serrated, 6" (15 cm)

WILLIAMS SPLINTER FORCEPS



KM39509

KM39511

KM39513

ITEM #	DESCRIPTION
KM39509	Straight, serrated, 5-1/2" (14 cm)
KM39511	45 degree angled, serrated, 5-1/4" (13.5 cm)
KM39513	90 degree angled, serrated, 5-1/2" (14 cm)

FORCEPS AND CLAMPS

Dressing Forceps

THUMB DRESSING FORCEPS



Pilling® Pattern, satin finish. Standard, serrated tips.

ITEM #	DESCRIPTION
181102	2.7 mm tip, 5" (12.5 cm)
181104	3.4 mm tip, 5-1/2" (14 cm)
181106	3.5 mm tip, 6" (15 cm)
181108	4 mm tip, 7-1/4" (18.5 cm)

THUMB DRESSING FORCEPS



Weck® Pattern, bright finish. Standard, serrated tips.

ITEM #	DESCRIPTION
465100	2.6 mm tip, 4-5/8" (11.5 cm)
465105	2.7 mm tip, 5" (12.5 cm)
465110	3 mm tip, 5-5/8" (14.5 cm)
465115	3.5 mm tip, 6-1/4" (16 cm)
465120	3.6 mm tip, 7-7/8" (20 cm)
465125	4 mm tip, 9-7/8" (25 cm)
465130	4.7 mm tip, 12" (30.5 cm)

THUMB FORCEPS



Weck® Pattern, bright finish. Narrow, serrated tips.

ITEM #	DESCRIPTION
465150	2 mm tip, 4-5/8" (11.5 cm)
465155	2 mm tip, 5" (12.5 cm)
465160	2 mm tip, 5-5/8" (14.5 cm)
465165	2 mm tip, 6" (15 cm)
465170	2.1 mm tip, 7-7/8" (20 cm)

ADSON DRESSING FORCEPS

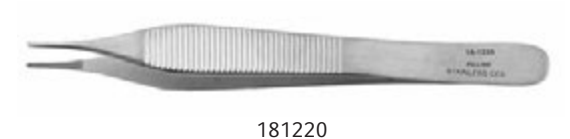

Pilling® Pattern, satin finish.

ITEM #	DESCRIPTION
181220	4-3/4" (12 cm)

FORCEPS AND CLAMPS

Dressing Forceps

ADSON DRESSING FORCEPS



057200

Weck® Pattern, serrated tip.

ITEM #	DESCRIPTION
057200	Standard, 1.3 mm tip, 4-3/4" (12 cm)
057202	Delicate, 1.2 mm tip, 5" (12.5 cm)

ADSON DRESSING FORCEPS TC



057205

Weck® Pattern, tungsten carbide.

ITEM #	DESCRIPTION
057205	Standard, 4-3/4" (12 cm), TC

ADSON DRESSING FORCEPS



KM39060

KMedic® Pattern.

ITEM #	DESCRIPTION
KM39058	Micro tip, serrated, 1 mm tip, 4-3/4" (12 cm)
KM39060	Delicate, serrated, 1.2 mm tip, 4-3/4" (12 cm)
KM39062	Standard tip, serrated, 4-3/4" (12 cm)
KM39059	Micro serrated, 1 mm tip, 6" (15 cm)
KM39052	Serrated, 1.2 mm tip, 6" (15 cm)

EWALD DRESSING FORCEPS



181237

Pilling® Pattern, satin finish. Delicate tips designed for careful handling of tissue. Handles are broad for comfortable, secure grasp.

ITEM #	DESCRIPTION
181237	Serrated, 4-3/4" (12 cm)

FORCEPS AND CLAMPS

Dressing Forceps

ADSON LASER TISSUE FORCEPS

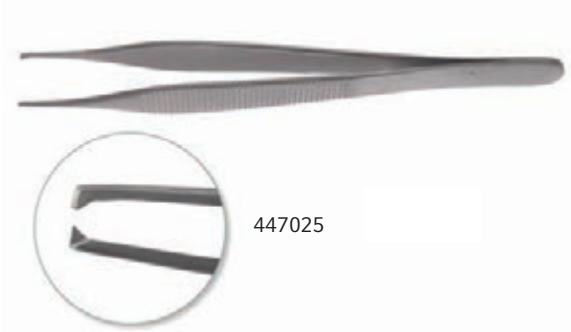

Ebonized.

ITEM #	DESCRIPTION
447025	1 x 2 teeth, 4-3/4" (12 cm)

CUSHING DRESSING FORCEPS



181410

Serrated handles, scraper end.

ITEM #	DESCRIPTION
181410	Straight, serrated tips, 7" (18 cm)

CUSHING DRESSING FORCEPS TC



351860

ITEM #	DESCRIPTION
351860	Straight, 6-7/8" (17.5 cm), TC

CUSHING DRESSING FORCEPS



466200

Weck® Pattern, bright finish.

ITEM #	DESCRIPTION
466200	Straight, serrated, 1.5 mm tip, 7" (18 cm)

CUSHING GUTSCH DRESSING FORCEPS



466211

Tungsten carbide.

ITEM #	DESCRIPTION
466211	Serrated, 1.8 mm tip, 6-7/8" (17.5 cm), TC
466210	Serrated, 1.6 mm tip, 7" (18 cm), TC

FORCEPS AND CLAMPS

Dressing Forceps

CUSHING BAYONET DRESSING FORCEPS



ITEM #	DESCRIPTION
351861	7-1/2" (19 cm), TC

CUSHING GUTSCH BAYONET DRESSING FORCEPS



Serrated handles, scraper end.

ITEM #	DESCRIPTION
466220	Serrated, 1.5 mm tip, 7-1/4" (18.5 cm)

GERALD DRESSING FORCEPS



These are full-size dressing forceps with only the distal portion narrowed to provide light, delicate tips that maintain alignment.

ITEM #	DESCRIPTION
351900	Serrated, 7" (18 cm)
351902	Serrated, 9-3/4" (25 cm)

GERALD DRESSING FORCEPS TC



ITEM #	DESCRIPTION
466225	Straight, serrated, 1.1 mm tip, 6-7/8" (17.5 cm), TC



FORCEPS AND CLAMPS

Dressing Forceps

IRIS DRESSING FORCEPS



ITEM #	DESCRIPTION
181600	Straight, 4" (10 cm)
181602	Slightly curved, 4" (10 cm)

DRESSING FORCEPS



ITEM #	DESCRIPTION
KM38082	Curved, fine point serrated, 5" (12.5 cm)

GRUENWALD BAYONET FORCEPS



ITEM #	DESCRIPTION
466151	Serrated, 2.3 mm tip, 8-3/8" (21.5 cm)

FORCEPS AND CLAMPS

Dressing Forceps

JANSEN BAYONET DRESSING FORCEPS



466150

ITEM #	DESCRIPTION
KM55100	Serrated, 2.1 mm tip, 6-1/4" (16 cm)
466150	Serrated, 2.4 mm tip, 7-5/8" (19.5 cm)

LUCAE BAYONET DRESSING FORCEPS



027100

ITEM #	DESCRIPTION
027100	Delicate, 1.5 mm tip, 5-1/2" (14 cm)

LUCAE BAYONET DRESSING FORCEPS



031100

ITEM #	DESCRIPTION
031100	Serrated, 2 mm tip, 6-1/2" (16.5 cm)

THUMB BAYONET DRESSING FORCEPS



395118

ITEM #	DESCRIPTION
395118	Angled, smooth, 7-1/4" (18.5 cm)



FORCEPS AND CLAMPS

Dressing Forceps

NEVINS FORCEPS



ITEM #	DESCRIPTION
466160	Straight, 1.5 mm serrated tip, 6-3/4" (17 cm)

POTTS-SMITH DRESSING FORCEPS



Fine, serrated tips.

ITEM #	DESCRIPTION
351850	7-1/4" (18.5 cm)
351852	8-1/4" (21 cm)
351854	9-5/8" (24.5 cm)
351856	10-1/4" (26 cm)
351858	11-7/8" (30 cm)

POTTS-SMITH TECHNIQUE® DRESSING FORCEPS



Narrow, serrated, TC tips.

ITEM #	DESCRIPTION
351862	7" (18 cm), TC
351863	8" (20.5 cm), TC
351864	9-3/4" (25 cm), TC
351865	10-1/4" (26 cm), TC

FORCEPS AND CLAMPS

Dressing Forceps

BRIGHAM DRESSING FORCEPS



466170

ITEM #	DESCRIPTION
466170	Serrated, 1.7 mm dissecting tip, 6-1/8" (15.5 cm)

SEMKEN DRESSING FORCEPS



KM39086

ITEM #	DESCRIPTION
181270	Serrated, 5" (12.5 cm)
KM39086	Serrated, 1.8 mm tip, 6" (15 cm)

Tissue Forceps

THUMB TISSUE FORCEPS



181131

Pilling® Pattern, satin finish. 1 x 2 teeth.

ITEM #	DESCRIPTION
181127	2 mm tip, 5" (12.5 cm)
181129	2.6 mm tip, 5-1/2" (14 cm)
181131	2.4 mm tip, 6" (15 cm)
181133	3.3 mm tip, 7-1/4" (18.5 cm)
181139	3.4 mm tip, 11-3/4" (30 cm)

THUMB TISSUE FORCEPS



181166

Pilling® Pattern, satin finish.

ITEM #	DESCRIPTION
181155	1 x 2 teeth, extra-fine 2.6 mm tip, 5-1/2" (14 cm)
181166	2 x 3 teeth, 6-1/4" (16 cm)

FORCEPS AND CLAMPS

Tissue Forceps

TISSUE FORCEPS



KMedic® Pattern, satin finish.

ITEM #	DESCRIPTION
KM38304	3 x 4 teeth, 5-1/2" (14 cm)

THUMB TISSUE FORCEPS



Weck® Pattern, bright finish. 1 x 2 teeth.

ITEM #	DESCRIPTION
467100	2.0 mm tip, 4-1/2" (11.5 cm)
467105	2.2 mm tip, 5" (12.5 cm)
467110	2.2 mm tip, 5-5/8" (14.5 cm)
467115	2.3 mm tip, 6-1/4" (16 cm)
467120	2.7 mm tip, 8" (20.5 cm)
467125	3.4 mm tip, 9-5/8" (24.5 cm)

TISSUE FORCEPS



Pilling® Pattern, satin finish.

ITEM #	DESCRIPTION
181310	1.5 mm tip, 1 x 2 teeth, serrated, 6" (15 cm)

FORCEPS AND CLAMPS

Tissue Forceps

ADSON TISSUE FORCEPS



Pilling® Pattern, satin finish.

ITEM #	DESCRIPTION
181223	1 x 2 teeth, 4-3/4" (12 cm)
181225	2 x 3 teeth, 5" (12.5 cm)
181228	1 x 2 teeth, serrated, 4-3/4" (12 cm)

ADSON TISSUE FORCEPS



Weck® Pattern, bright finish.

ITEM #	DESCRIPTION
057207	1 x 2 teeth, 1.3 mm tip, 4-3/4" (12 cm)
057210	Standard, 1 x 2 teeth, 1.4 mm tip, 4-3/4" (12 cm)
057212	Delicate, 1 x 2 teeth, 1.2 mm tip, 5" (12.5 cm)
057214	Delicate, serrated, 1 x 2 teeth, 1.3 mm tip, 4-7/8" (12.5 cm)
057230	2 x 3 teeth, 2 mm tip, 5" (12.5 cm)

FORCEPS AND CLAMPS

Tissue Forceps

CALLISON-ADSON TISSUE FORCEPS



057220

Weck® Pattern, bright finish.

ITEM #	DESCRIPTION
057220	1 x 2 teeth with tying platform, 1.3 mm tip, 4-3/4" (12 cm)

ADSON TISSUE FORCEPS



KM39057

KMedic® Pattern, satin finish.

ITEM #	DESCRIPTION
KM39056	Micro 1 x 2 teeth, 0.8 mm tip, 4-3/4" (12 cm)
KM39057	Micro 1 x 2 teeth, 0.9 mm tip, 6" (15 cm)
KM39064	Delicate 1 x 2 teeth, 4-3/4" (12 cm)
KM39050	1 x 2 teeth, 1.2 mm tip, 6" (15 cm)

ADSON-DEBAKEY® TISSUE FORCEPS



KM39054

KMedic® Pattern, satin finish. DeBakey® teeth.

ITEM #	DESCRIPTION
KM39054	1.5 mm tip, 4-3/4" (12 cm)

BROWN-ADSON TISSUE FORCEPS



181235

Pilling® Pattern, satin finish. Delicate tips designed for careful handling of tissue. Handles are broad for comfortable, secure grasp.

ITEM #	DESCRIPTION
181235	9 x 9 teeth, 4-3/4" (12 cm)

BROWN-ADSON TISSUE FORCEPS



057250

Weck® Pattern, satin finish.

ITEM #	DESCRIPTION
057250	7 x 7 teeth, 2 mm tip, 4-3/4" (12 cm)

FORCEPS AND CLAMPS

Tissue Forceps

ADSON BROWN LASER TISSUE FORCEPS



Ebonized.

ITEM #	DESCRIPTION
447030	Straight, 9 x 9 teeth, 4-3/4" (12 cm)

EWALD TISSUE FORCEPS



Pilling® Pattern, satin finish. Delicate tips designed for careful handling of tissue. Handles are broad for comfortable, secure grasp.

ITEM #	DESCRIPTION
181240	1 x 2 teeth, 4-3/4" (12 cm)

HUDSON TISSUE FORCEPS



ITEM #	DESCRIPTION
057215	1 x 2 teeth, heavy, 1.5 mm tip, 5" (12.5 cm)



FORCEPS AND CLAMPS

Tissue Forceps

BEASLEY-BABCOCK TISSUE FORCEPS



ITEM #	DESCRIPTION
057302	6 x 6 teeth, 5-1/4" (13.5 cm)

BONNEY TISSUE FORCEPS



Strong, rugged construction. Serrated tying platform. Non-slip handles.

ITEM #	DESCRIPTION
640524	1 x 2 teeth, 3.3 mm tip, 6-3/4" (17 cm)
181327	2 x 3 teeth, 6-3/4" (17 cm)

BROWN TISSUE FORCEPS



Small 9 x 9 sets of teeth run longitudinally along narrow jaws.

ITEM #	DESCRIPTION
181255	6" (15 cm)
342965	8" (20.5 cm)
342967	9-1/2" (24 cm)

FORCEPS AND CLAMPS

Tissue Forceps

CUSHING BAYONET TISSUE FORCEPS



468240

Serrated handles, scraper end.

ITEM #	DESCRIPTION
468240	1 x 2 teeth, 7-1/4" (18.5 cm)

CUSHING GUTSCH TISSUE FORCEPS



468230

ITEM #	DESCRIPTION
468230	1 x 2 teeth, serrated, 7" (18 cm)

CUSHING TISSUE FORCEPS

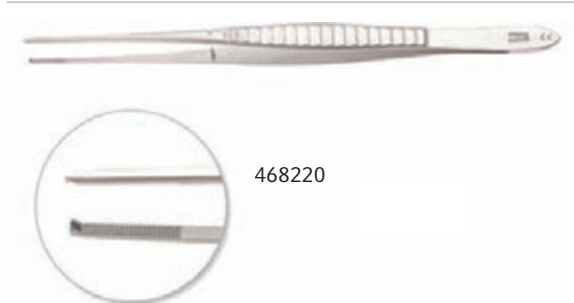

468220

ITEM #	DESCRIPTION
468220	1 x 2 teeth, serrated, 7" (18 cm)

DEBAKEY® THORACIC TISSUE FORCEPS



342980

342986

The row of 1 x 2 DeBakey®-type serrations on the tips are designed to be large and strong enough to handle relatively large masses of tissue. Because of the groove construction and light spring tension, they may be used to hold and handle suture material as well. These forceps are of heavier design than the DeBakey® Vascular Tissue Forceps (351800 through 351814 on page 48). The distal portion is tapered to a 3 mm DeBakey®-type Tip.

ITEM #	DESCRIPTION
342980	Straight, 3 mm tip, 6-1/8" (15.5 cm)
342981	Straight, 3 mm tip, 7-3/4" (19.5 cm)
342982	Straight, 3 mm tip, 9-1/2" (24 cm)
342984	Straight, 3 mm tip, 12" (30.5 cm)
342986	Angled, 3 mm tip, 12" (30.5 cm)

FORCEPS AND CLAMPS

Tissue Forceps

DEBAKEY® VASCULAR TISSUE FORCEPS



351800



351810

Standard. The distal 2 cm of these forceps is a narrow DeBakey®-type serration with a width of 2 mm. The body of the instrument is constructed especially to prevent feathering and all pins and projections have been omitted to help eliminate suture catchers. Jaws are very well-fitted for handling tiny vessels as well as the smallest suture material.

ITEM #	DESCRIPTION
351800	Straight, 2 mm tip, 6" (15 cm)
351802	Straight, 2 mm tip, 7-3/4" (19.5 cm)
351804	Straight, 2 mm tip, 9-1/2" (24 cm)
351808	Straight, 2 mm tip, 12" (30.5 cm)
351810	Angled, 2 mm tip, 6" (15 cm)
351812	Angled, 2 mm tip, 7-3/4" (19.5 cm)
351814	Angled, 2 mm tip, 9-1/2" (24 cm)

DEBAKEY®-DIETRICH DELICATE VASCULAR TISSUE FORCEPS



351803



Designed for micro-vascular and coronary artery surgery. The distal portion is tapered to a 1 mm extra fine DeBakey®-type serration.

ITEM #	DESCRIPTION
351801	Straight, delicate, 1 mm tip, 6" (15 cm)
351803	Straight, delicate, 1 mm tip, 7-3/4" (19.5 cm)
351806	Straight, delicate, 1 mm tip, 9-1/2" (24 cm)

DEBAKEY® ULTRALIGHT FORCEPS



351821



Approximately one-half the weight of standard DeBakey® Forceps, similar to that of titanium but at a much lower price. Ebonized stainless steel to reduce glare. Reduced tension minimizes fatigue and allows better control of delicate tissues.

ITEM #	DESCRIPTION
351820	1.5 mm tip, 6" (15 cm)
351821	1.5 mm tip, 7-3/4" (19.5 cm)

FORCEPS AND CLAMPS

Tissue Forceps

DEBAKEY® CARBIDE FORCEPS

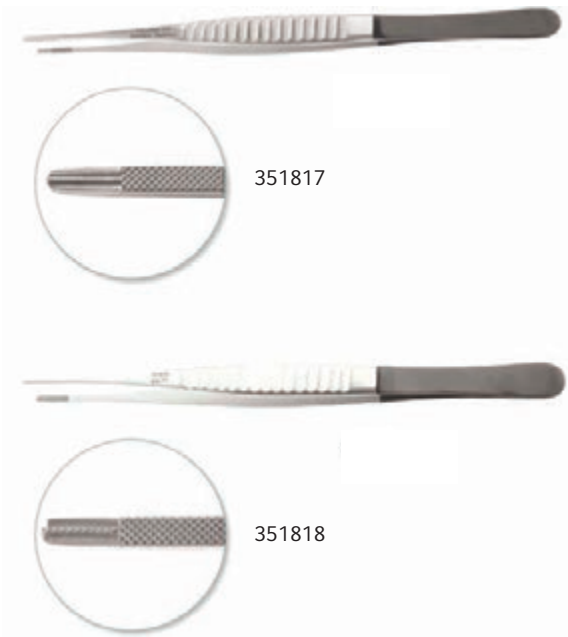

DeBakey®-type serrations at distal tip. Tungsten carbide insert behind the jaw for secure needle pulling actions.

ITEM #	DESCRIPTION
351815	Regular forceps, 6" (15 cm), TC
351817	Regular forceps, 7-3/4" (19.5 cm), TC
351818	Delicate forceps, 7-3/4" (19.5 cm), TC
351819	Regular forceps, 9-1/2" (24 cm), TC
351824	Delicate forceps, 9-1/2" (24 cm), TC

VASCULAR DEBAKEY® BAYONET TISSUE FORCEPS

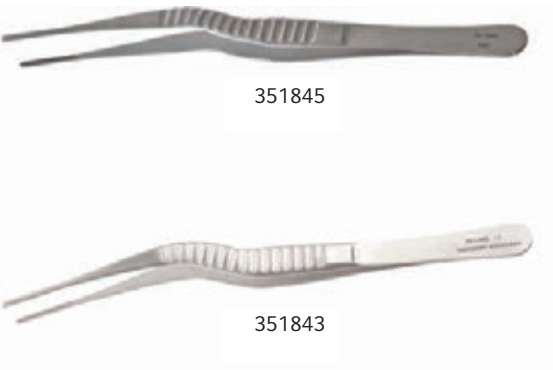

DeBakey®-type serrations with a bayonet shape. Angled handles for difficult access and increased visibility.

ITEM #	DESCRIPTION
351845	Fine, 1.3 mm tip, 7-3/4" (19.5 cm)
351843	Standard, 2.0 mm tip, 7-3/4" (19.5 cm)

FORCEPS AND CLAMPS

Tissue Forceps

DEBAKEY® TITANIUM TISSUE FORCEPS

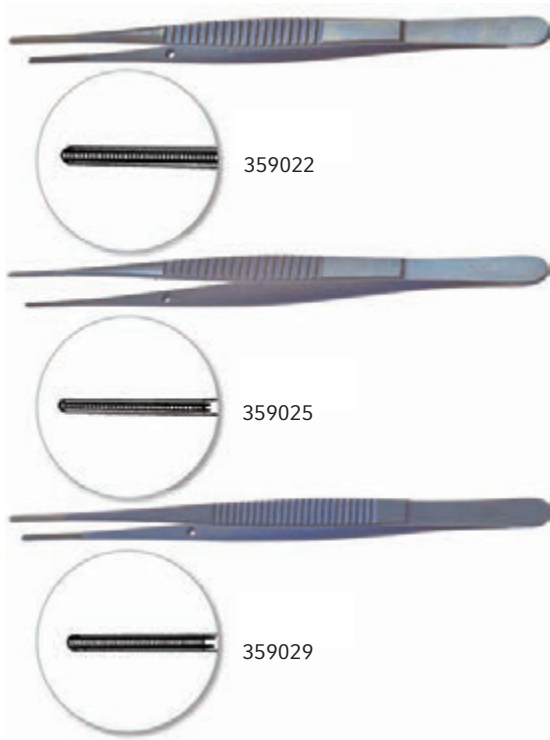

ITEM #	DESCRIPTION
359024	Straight, flat handle, 1.5 mm jaw width, 6" (15 cm)
359025	Straight, flat handle, 1.5 mm jaw width, 7-5/8" (19.5 cm)
359021	Straight, flat handle, 2.5 mm jaw width, 6" (15 cm)
359022	Straight, flat handle, 2.5 mm jaw width, 7-5/8" (19.5 cm)
359027	Straight, flat handle, 3 mm jaw width, 6" (15 cm)
359028	Straight, flat handle, 3 mm jaw width, 7-5/8" (19.5 cm)
359029	Straight, flat handle, 3 mm jaw width, 9-1/2" (24 cm)
359030	Angular, flat handle, 2.5 mm jaw width, 5-7/8" (15 cm)
359031	Angular, flat handle, 2.5 mm jaw width, 7-1/2" (19 cm)
359032	Angular, flat handle, 2.5 mm jaw width, 9-1/4" (23.5 cm)

FERRIS SMITH TISSUE FORCEPS



468190

ITEM #	DESCRIPTION
468190	2 x 3 teeth with 4 mm serrated tying platform. 6-7/8" (17.5 cm)

GERALD TISSUE FORCEPS



351905

These are full-size tissue forceps with only the distal portion narrowed to provide light, delicate tips that maintain alignment.

ITEM #	DESCRIPTION
351905	1 x 2 teeth, 7" (18 cm)
351907	1 x 2 teeth, 9-3/4" (25 cm)



FORCEPS AND CLAMPS

Tissue Forceps

GERALD DEBAKEY® TISSUE FORCEPS



Delicate, tapered DeBakey®-type serrations.

ITEM #	DESCRIPTION
351901	7" (18 cm)
351908	8" (20.5 cm)
351909	9-1/2" (24 cm)
351910	Angled, 6-7/8" (17.5 cm)

GRAEFE TISSUE FORCEPS



ITEM #	DESCRIPTION
181250	5 x 6 teeth, 4-3/8" (11 cm)

FORCEPS AND CLAMPS

Tissue Forceps

IRIS TISSUE FORCEPS

Delicate.

ITEM #	DESCRIPTION
181610	Straight, 1 x 2 teeth, 4" (10 cm)
181614	Full curve, 1 x 2 teeth, 3-3/4" (9.5 cm)
181604	Full curve, 3-3/4" (9.5 cm)

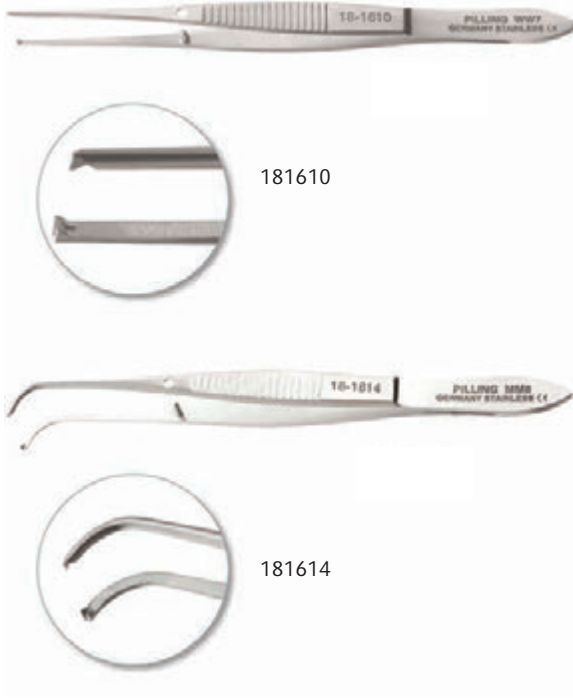

SEMKIN TISSUE FORCEPS

These delicate forceps are midway in size between Iris forceps and delicate standard tissue forceps.

ITEM #	DESCRIPTION
181272	1 x 2 teeth, 5" (12.5 cm)
KM39088	1 x 2 teeth, 6-1/4" (16 cm)



FORCEPS AND CLAMPS

Tissue Forceps

NELSON TISSUE FORCEPS

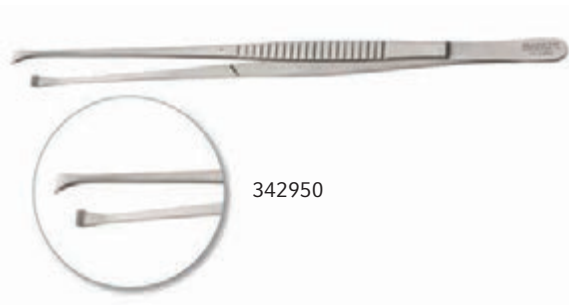

ITEM #	DESCRIPTION
342950	6 x 7 sharp, fine teeth, 9" (23 cm)

SINGLEY TISSUE FORCEPS



Serrated ring end 8.5 mm wide. Medium-heavy construction.

ITEM #	DESCRIPTION
342933	9" (23 cm)

ADAMS TISSUE FORCEPS



ITEM #	DESCRIPTION
351835	Delicate, 1 mm tip, 8" (20.5 cm), TC

TUTTLE THORACIC TISSUE FORCEPS



Light construction. Ring tips 6.8 mm wide.

ITEM #	DESCRIPTION
342935	9" (23 cm)

FORCEPS AND CLAMPS

Tissue Forceps

CORONARY ULTRA FINE TISSUE FORCEPS



Tungsten carbide.

ITEM #	DESCRIPTION
351837	7" (18 cm), TC
351838	8" (20.5 cm), TC
351839	9" (23 cm), TC

WHEELER TECHNIQUE® PLAQUE AND VESSEL FORCEPS



Very powerful grip at tip.

ITEM #	DESCRIPTION
351825	DeBakey®-type jaw, 1.6 mm, 5-1/2" (14 cm)
351827	DeBakey®-type jaw, 1.6 mm, 7-1/8" (18 cm)
351829	DeBakey®-type jaw, 1.6 mm, 8-3/4" (22 cm)

CRAFOORD TISSUE FORCEPS



Serrated tips are built up to provide an unusually secure grip.

ITEM #	DESCRIPTION
351898	Serrated, 8" (20.5 cm)

POTTS-SMITH TISSUE FORCEPS



Fine, serrated, 1 x 2 distal teeth.

ITEM #	DESCRIPTION
351870	7-1/4" (18.5 cm)
351872	8-1/4" (21 cm)
351874	9-1/2" (24 cm)
351876	10-1/4" (26 cm)

FORCEPS AND CLAMPS

Tissue Forceps

RUSSIAN TISSUE FORCEPS



ITEM #	DESCRIPTION
181360	6" (15 cm)
181365	8" (20.5 cm)
181370	10" (25.5 cm)

C.W. MAYO TISSUE FORCEPS



Russian-type fenestrated tips are 6.7 mm wide and deeply serrated.

ITEM #	DESCRIPTION
342910	9" (23 cm)

DAVIS TISSUE FORCEPS



Russian-type jaws, 7.5 mm wide.

ITEM #	DESCRIPTION
342915	Straight, serrated, 10" (25.5 cm)

SELMAN TISSUE FORCEPS



Small diameter circular tips have meshing teeth for secure, non-damaging grip.

ITEM #	DESCRIPTION
351840	6" (15 cm)
351841	8" (20.5 cm)
351842	10" (25.5 cm)

FORCEPS AND CLAMPS

Hemostatic Forceps and Clamps

ADSON HEMOSTATIC FORCEPS



30 mm jaw, 2 mm tip, two-thirds serrations.

ITEM #	DESCRIPTION
477190	Straight, 7-1/2" (19 cm)
477191	Curved, 7-1/8" (18 cm)

PILLING® THORACIC ARTERY FORCEPS

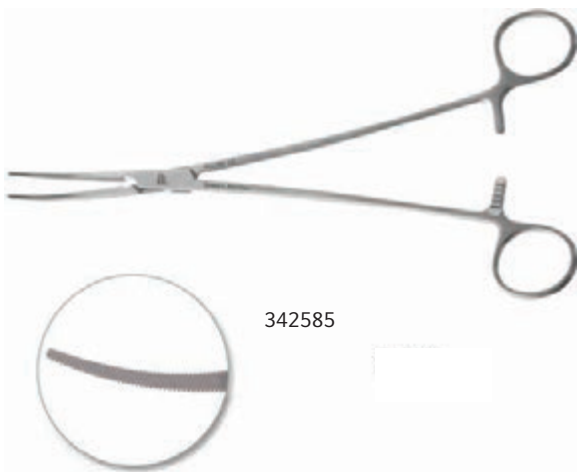

Slim, slightly curved jaws have very light criss-cross serrations making this an excellent instrument for handling suture material as well as delicate tissue.

ITEM #	DESCRIPTION
342585	Serrated, 2" (5 cm) tip length, 2 mm tip width, 9-1/4" (23.5 cm)

FORCEPS AND CLAMPS

Hemostatic Forceps and Clamps

LEJEUNE THORACIC FORCEPS

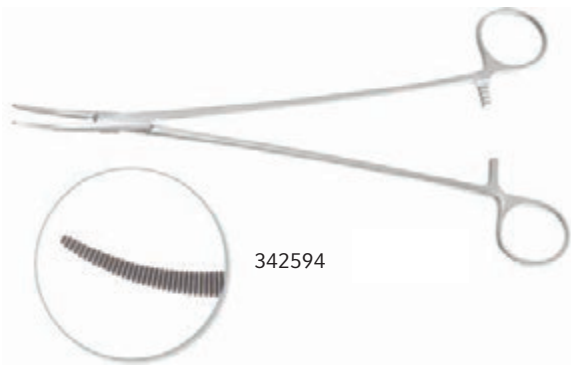

ITEM #	DESCRIPTION
342594	Slightly curved, serrated, 1-3/8" (3.5 cm) tip length, 1.8 mm tip width, 9-3/8" (24 cm)

BENGOLEA FORCEPS



Lightweight, with narrow, criss-cross serrated jaws.

ITEM #	DESCRIPTION
342587	Slightly curved, serrated, 2 mm wide tip, 8-1/2" (21.5 cm)

BRIDGE HEMOSTATIC FORCEPS

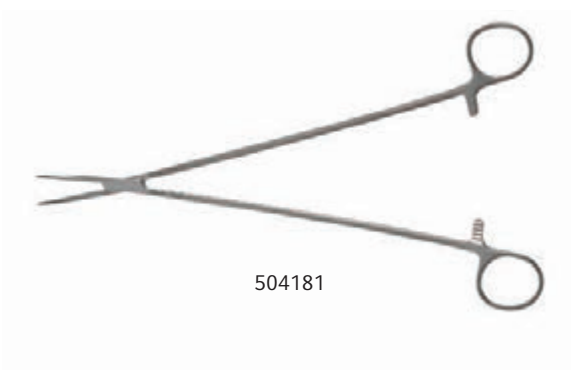

32 mm serrated jaw.

ITEM #	DESCRIPTION
504180	Straight, 2 mm tip, 11-1/8" (28.5 cm)
504181	Curved, 2 mm tip, 11" (28 cm)
540111	Curved, 1.6 mm tip, 6-7/8" (17.5 cm)

FORCEPS AND CLAMPS

Hemostatic Forceps and Clamps

CARMALT FORCEPS

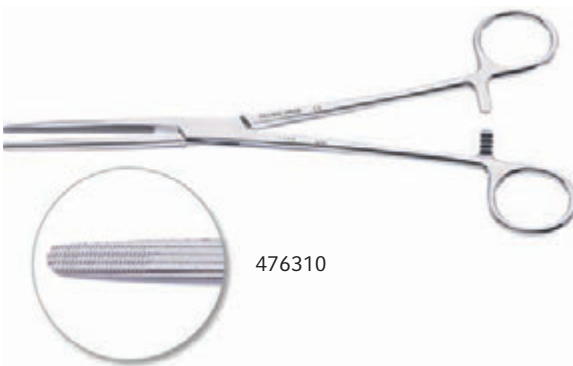

Cross-serrated tip with longitudinally serrated jaw.

ITEM #	DESCRIPTION
476300	Straight, 43 mm jaw, 3 mm tip, 6-1/2" (16.5 cm)
476310	Straight, 58 mm jaw, 4 mm tip, 8-1/4" (21 cm)
476330	Curved, 43 mm jaw, 3 mm tip, 6-1/2" (16.5 cm)
476340	Curved, 58 mm jaw, 4 mm tip, 8-1/4" (21 cm)



FORCEPS AND CLAMPS

Hemostatic Forceps and Clamps

COLLER FORCEPS

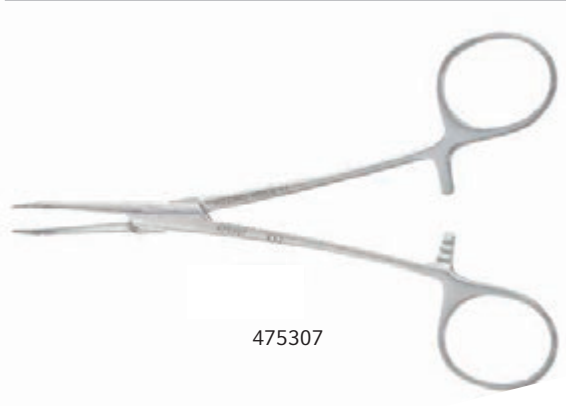

475307



477110

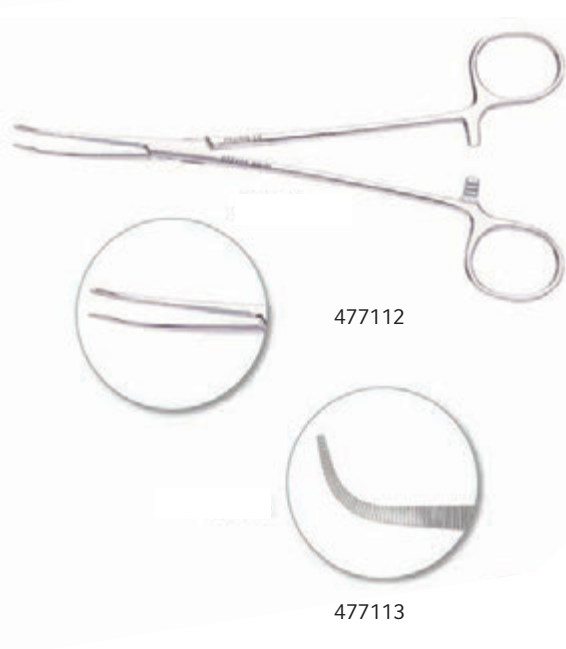

477112

477113

ITEM #	DESCRIPTION
475305	Skillman serrations, straight, 31 x 1.7 mm tip, 5-1/2" (14 cm)
475306	Skillman serrations, curved, 29 x 1.7 mm tip, 5-3/8" (13.5 cm)
475307	Skillman serrations, strongly curved, 26 x 1.7 mm tip, 5-3/8" (13.5 cm)
477109	Straight, 38 x 1.8 mm tip, 1 x 3 catch, 6-5/8" (17 cm)
477110	Curved, 38 x 1.8 mm tip, 1 x 3 catch, 6-5/8" (17 cm)
477112	Curved, 42 x 1.7 mm tip, 1 x 3 catch, 7-1/4" (18.5 cm)
477113	Strongly curved, 37 x 1.6 mm tip, 1 x 3 catch, 7" (18 cm)
477116	Curved, 44 x 2 mm tip, 4 x 4 catch, 9-3/8" (24 cm)
477117	Strongly curved, 40 x 2 mm tip, 4 x 4 catch, 9-1/4" (23.5 cm)
477118	Angled, 32 x 2 mm tip, 4 x 4 catch, 8-7/8" (22.5 cm)



477118

FORCEPS AND CLAMPS

Hemostatic Forceps and Clamps

COLLIER HEMOSTATIC FORCEPS



A Crile-type forceps with a lighter distal end for more delicate procedures.

ITEM #	DESCRIPTION
182085	Straight, 5-1/2" (14 cm)
182086	Curved, 5-1/2" (14 cm)
182090	Straight, 6-1/4" (16 cm)
182095	Curved, 6-1/4" (16 cm)
182097	Straight, 7-3/4" (19.5 cm)
182098	Curved, 7-1/4" (18.5 cm)

CRILE HEMOSTATS



Pilling® Pattern, satin finish, standard tip, full serrations.

ITEM #	DESCRIPTION
182050	Straight, 5-3/4" (14.5 cm)
182060	Curved, 5-1/2" (14 cm)
182070	Straight, 6-1/4" (16 cm)
182080	Curved, 6-1/4" (16 cm)

CRILE FORCEPS

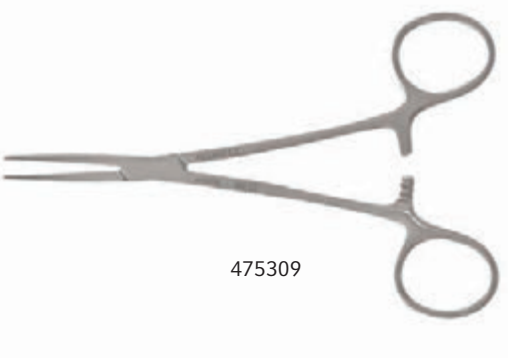

Weck® Pattern, bright finish, full serrations.

ITEM #	DESCRIPTION
475308	Straight, 5-5/8" (14.5 cm)
475309	Curved, 5-3/4" (14.5 cm)

FORCEPS AND CLAMPS

Hemostatic Forceps and Clamps

CRILE FORCEPS



Weck® Pattern, bright finish, delicate, full serrations.

ITEM #	DESCRIPTION
475310	Straight, 1.8 mm tip, 5-1/2" (14 cm)
475311	Curved, 1.8 mm tip, 5-3/8" (13.5 cm)
475312	Straight, 1.7 mm tip, 6-3/8" (16 cm)
475313	Curved, 2 mm tip, 6-1/4" (16 cm)

DANDY HEMOSTATIC FORCEPS



Pilling® Pattern, satin finish.

ITEM #	DESCRIPTION
181822	Curved sideways, 5-1/2" (14 cm)

DANDY KOLODNY FORCEPS

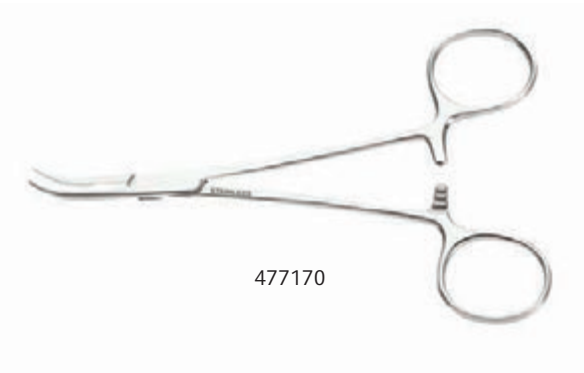

Weck® Pattern, bright finish.

ITEM #	DESCRIPTION
477170	Curved sideways, one-half horizontal serrations, 5-3/8" (13.5 cm)

FORCEPS AND CLAMPS

Hemostatic Forceps and Clamps

HALSTED MOSQUITO FORCEPS



Pilling® Pattern, satin finish, full serrations.

ITEM #	DESCRIPTION
182300	Straight, 5-1/4" (13.5 cm)
182310	Curved, 5-1/8" (13 cm)
182350	Straight, 4" (10 cm)
182355	Curved, 4" (10 cm)

HALSTED MOSQUITO FORCEPS



Weck® Pattern, bright finish, serrated jaw.

ITEM #	DESCRIPTION
475084	Straight, 1.2 mm tip, 4-3/4" (12 cm)
475086	Curved, 1.2 mm tip, 4-5/8" (11.5 cm)
475100	Straight, 1.6 mm tip, 5-1/4" (13.5 cm)
475101	Curved, 1.6 mm tip, 5-1/8" (13 cm)

HALSTED MOSQUITO FORCEPS WITH TEETH



Weck® Pattern, bright finish.

ITEM #	DESCRIPTION
475102	Straight, 1 x 2 teeth, 1.5 mm tip, 5" (12.5 cm)



FORCEPS AND CLAMPS

Hemostatic Forceps and Clamps

HARTMAN MOSQUITO FORCEPS



Weck® Pattern, bright finish. Delicate, serrated jaw.

ITEM #	DESCRIPTION
475080	Straight, 20 mm jaw, 1.3 mm tip, 4" (10 cm)
475082	Curved, 20 mm jaw, 1.3 mm tip, 4" (10 cm)

MOSQUITO FORCEPS



ITEM #	DESCRIPTION
075118	Curved, fully serrated, 1.7 x 2 mm tip, 7-1/4" (18.5 cm)

FORCEPS AND CLAMPS

Hemostatic Forceps and Clamps

MOSQUITO FORCEPS SERRATED



ITEM #	DESCRIPTION
KM36078	Curved, serrated, 1 x 2 teeth, 5" (12.5 cm)

SKILLMAN MOSQUITO FORCEPS



Weck® Pattern, bright finish. Full serrations.

ITEM #	DESCRIPTION
475130	Straight, 1.6 mm tip, 5-1/4" (13.5 cm)
475131	Curved, 1.6 mm tip, 5-1/8" (13 cm)

FORCEPS AND CLAMPS

Hemostatic Forceps and Clamps

JONES HEMOSTAT



Sturdy construction, fully serrated.

ITEM #	DESCRIPTION
182160	Straight, 5" (12.5 cm)

KELLY FORCEPS



Pilling® Pattern, satin finish. Half serrations.

ITEM #	DESCRIPTION
182100	Straight, 5-3/4" (14.5 cm)
182110	Curved, 5-1/2" (14 cm)

KELLY FORCEPS



Weck® Pattern, bright finish. Half serrations.

ITEM #	DESCRIPTION
475210	Straight, 5-1/2" (14 cm)
475211	Curved, 5-1/2" (14 cm)

FORCEPS AND CLAMPS

Hemostatic Forceps and Clamps

LAHEY TRACTION FORCEPS



ITEM #	DESCRIPTION
171155	Straight, 3 x 3 teeth, 6" (15 cm)

LAWRENCE HEMOSTATIC FORCEPS



Curved, serrated jaw.

ITEM #	DESCRIPTION
504171	31 mm jaw, 2 mm tip, 10-3/4" (27.5 cm)
540140	30 mm jaw, 1.7 mm tip, 6-3/4" (17 cm)

MASTIN MUSCLE FORCEPS

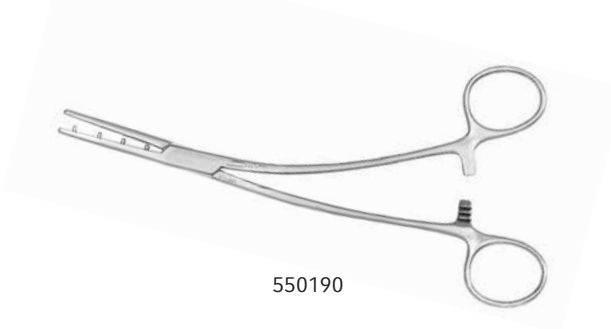

42 mm jaw with cross serrations on pin side only.

ITEM #	DESCRIPTION
550190	Curved on side, 3.1 mm tip, 6-5/8" (17 cm)

FORCEPS AND CLAMPS

Hemostatic Forceps and Clamps

MAYO-PEAN FORCEPS

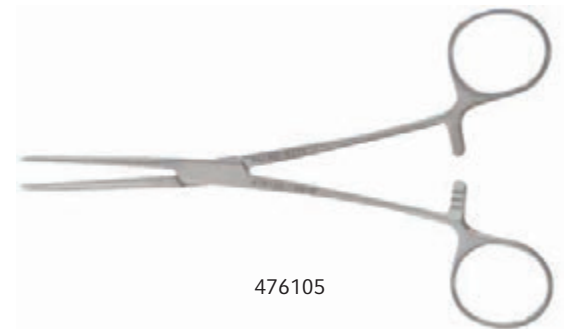

Weck® Pattern, bright finish. Straight hemostatic forceps with full serrations.

ITEM #	DESCRIPTION
476105	2.9 mm tip, 6-5/8" (17 cm)
476106	2.4 mm tip, 6-5/8" (17 cm)
476110	3.3 mm tip, 7-1/4" (18.5 cm)
476115	3.7 mm tip, 8-1/4" (21 cm)
476120	3.7 mm tip, 8-3/4" (22 cm)
476125	3.8 mm tip, 10-3/8" (26.5 cm)

MAYO-PEAN FORCEPS



Weck® Pattern, bright finish. Curved hemostatic forceps with full serrations.

ITEM #	DESCRIPTION
476150	2.5 mm tip, 5-5/8" (14.5 cm)
476155	2.9 mm tip, 6-1/2" (16.5 cm)
476156	2.4 mm tip, 6-1/2" (16.5 cm)
476160	3.3 mm tip, 7-1/8" (18 cm)
476165	3.7 mm tip, 8-1/4" (21 cm)
476170	3.5 mm tip, 9-1/4" (23.5 cm)
476175	3.8 mm tip, 10-1/4" (26 cm)

PEAN CLAMPS

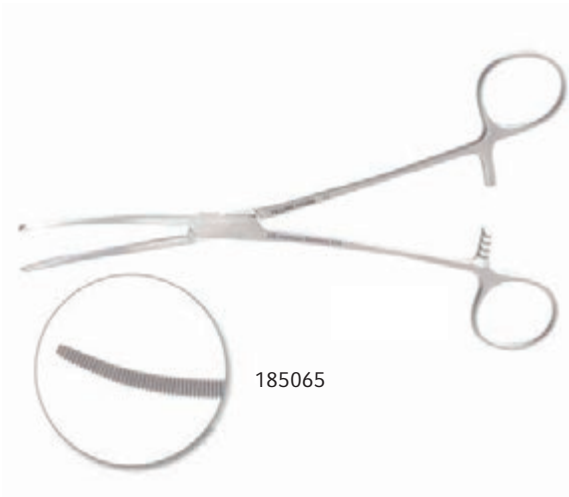

Pilling® Pattern, satin finish. Horizontal serrations.

ITEM #	DESCRIPTION
185060	Straight, 8-1/8" (20.5 cm)
185065	Curved, 8-1/8" (20.5 cm)
185066	Curved, 9-1/4" (23.5 cm)
185067	Straight, 10-1/8" (25.5 cm)

FORCEPS AND CLAMPS

Hemostatic Forceps and Clamps

ROCHESTER-PEAN FORCEPS

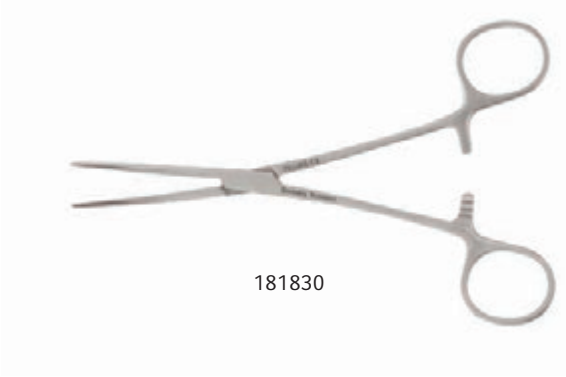

Pilling® Pattern, satin finish. Straight, full serrations.

ITEM #	DESCRIPTION
181830	Curved, 2 mm tip, 6-1/2" (16.5 cm)

ROCHESTER-PEAN FORCEPS



Pilling® Pattern, satin finish. Straight, full serrations.

ITEM #	DESCRIPTION
182400	2.7 mm tip, 5-1/2" (14 cm)
182405	2.8 mm tip, 6-1/2" (16.5 cm)
182415	3.0 mm tip, 7-1/4" (18.5 cm)
182420	3.2 mm tip, 8" (20.5 cm)

ROCHESTER-PEAN FORCEPS

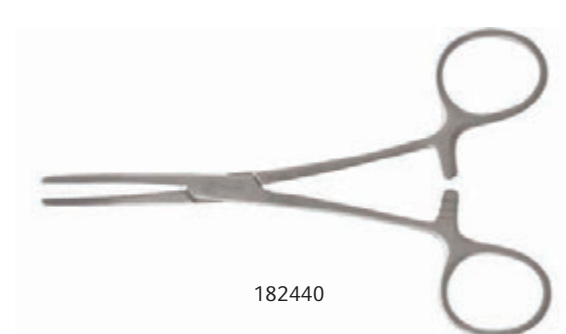

Pilling® Pattern, satin finish. Curved, full serrations.

ITEM #	DESCRIPTION
182440	3.2 mm tip, 5-1/2" (14 cm)
182445	2.8 mm tip, 6-1/4" (16 cm)
182455	3.0 mm tip, 7-1/4" (18.5 cm)
182460	3.2 mm tip, 8" (20.5 cm)

FORCEPS AND CLAMPS

Hemostatic Forceps and Clamps

ROCHESTER-PEAN FORCEPS, 12"



KM36362

KMedic® Pattern, satin finish.

ITEM #	DESCRIPTION
KM36360	Hemostatic, straight, 4.6 mm tip, 12" (30.5 cm)
KM36362	Curved, serrated, 12" (30.5 cm)

OCHSNER FORCEPS (KOCHER)



476205

Weck® Pattern, bright finish. Straight hemostatic forceps with full serrations, 1 x 2 teeth.

ITEM #	DESCRIPTION
476200	3 mm tip, 5-5/8" (14.5 cm)
476205	4.2 mm tip, 6-3/8" (16 cm)
476206	Light model, 2.5 mm tip, 6-3/8" (16 cm)
476210	3.3 mm tip, 7-1/4" (18.5 cm)
476215	4.5 mm tip, 8" (20.5 cm)
476220	5.5 mm tip, 8-7/8" (22.5 cm)
476225	5 mm tip, 10-3/8" (26.5 cm)

OCHSNER FORCEPS (KOCHER)



476255

Weck® Pattern, bright finish. Curved hemostatic forceps with full serrations, 1 x 2 teeth.

ITEM #	DESCRIPTION
476250	2.7 mm tip, 5-1/2" (14 cm)
476255	2.6 mm tip, 6-1/4" (16 cm)
476260	3.6 mm tip, 7-1/4" (18.5 cm)
476265	3.4 mm tip, 7-7/8" (20 cm)
476270	4 mm tip, 8-3/4" (22 cm)
476275	4 mm tip, 10-1/4" (26 cm)

FORCEPS AND CLAMPS

Hemostatic Forceps and Clamps

ROCHESTER-OCHSNER FORCEPS (KOCHER)

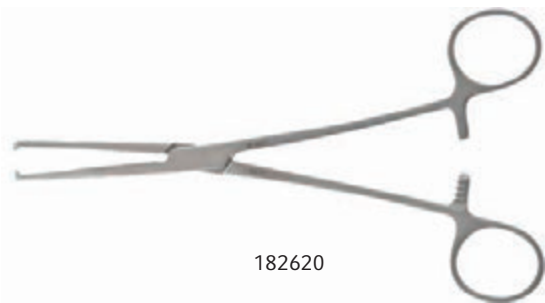

Pilling® Pattern, straight. Full serrations, 1 x 2 teeth.

ITEM #	DESCRIPTION
182600	5-1/2" (14 cm)
182605	6-1/4" (16 cm)
182615	7-1/4" (18.5 cm)
182620	8" (20.5 cm)

ROCHESTER-OCHSNER FORCEPS (KOCHER)



Pilling® Pattern, curved. Full serrations, 1 x 2 teeth.

ITEM #	DESCRIPTION
182655	6-1/4" (16 cm)
182665	7-1/4" (18.5 cm)
182670	Curved, 1 x 2 teeth, 8" (20.5 cm)

PROVIDENCE HOSPITAL FORCEPS



Weck® Pattern, bright finish. Two-thirds serrations.

ITEM #	DESCRIPTION
475200	Straight, 2 mm tip, 5-3/8" (13.5 cm)
475201	Curved, 2 mm tip, 5-3/8" (13.5 cm)

FORCEPS AND CLAMPS

Hemostatic Forceps and Clamps

PROVIDENCE HOSPITAL HEMOSTATS



Pilling® Pattern, satin finish. Half serrations.

ITEM #	DESCRIPTION
182140	Straight, 5-3/4" (14.5 cm)
182150	Curved, 5-5/8" (14.5 cm)

RANKIN FORCEPS

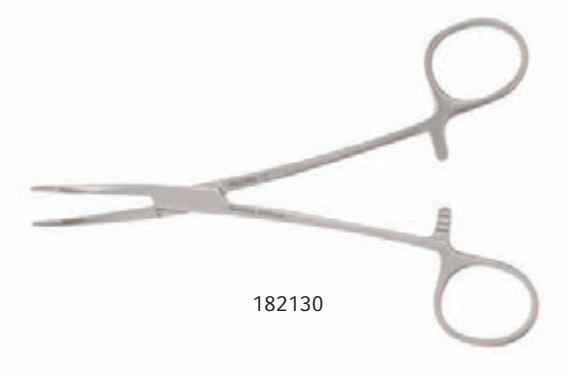

Pilling® Pattern, satin finish. Half serrations.

ITEM #	DESCRIPTION
182120	Straight, 6-1/4" (16 cm)
182130	Curved, 6-1/4" (16 cm)

RANKIN-KELLY HEMOSTAT FORCEPS



KMedic® Pattern, satin finish. Three-quarter serrations.

ITEM #	DESCRIPTION
KM36196	Straight, 6-1/4" (16 cm)
KM36198	Curved, serrated, 6-1/4" (16 cm)

FORCEPS AND CLAMPS

Hemostatic Forceps and Clamps

SAROT INTRA-THORACIC ARTERY FORCEPS

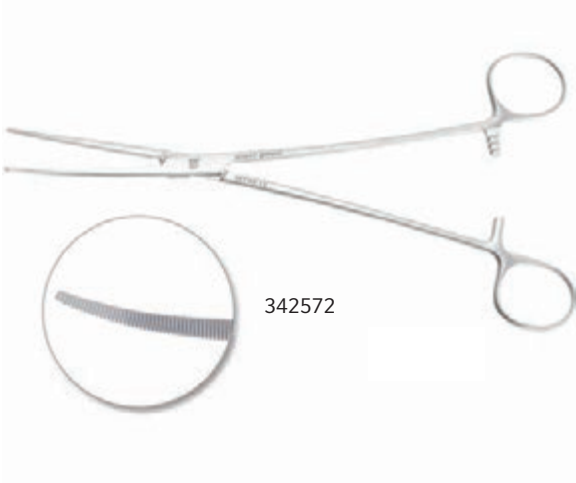

Slender, slightly curved forceps with serrated jaws. Specially designed for pulmonary resections, cardiovascular and esophageal surgery.

ITEM #	DESCRIPTION
342571	Medium, serrated, 1/2" (1.5 cm) tip length, 1.6 mm tip width, 7-5/8" (19.5 cm)
342572	Large, serrated, 2-1/4" (5.5 cm) tip length, 2 mm tip width, 9" (23 cm)

SCHNIDT FORCEPS (TONSIL)



Pilling® Pattern, satin finish. Half serrations.

ITEM #	DESCRIPTION
182390	Half curved, 7-1/2" (19 cm)

SCHNIDT FORCEPS (TONSIL)



Weck® Pattern, bright finish.

ITEM #	DESCRIPTION
075116	Slightly curved, 7-1/4" (18.5 cm)
075120	Lightly curved, serrated, 2 mm tip, 7-1/2" (19 cm)
075122	Strongly curved, serrated, 2 mm tip, 7-1/2" (19 cm)

FORCEPS AND CLAMPS

Hemostatic Forceps and Clamps

VANDERBILT VESSEL FORCEPS



This hemostatic-type forceps is particularly useful in cardiovascular and thoracic surgery but has been used extensively in general surgery as well. The elongated handles afford access to a number of surgical sites. Jaws are of a standard cross-serration design.

ITEM #	DESCRIPTION
342590	Slightly curved, 2" (5 cm) tip length, 2 mm tip width, 8-5/8" (22 cm)

SERREFINES CROSS-ACTION CLAMPS



Cross-action, full serrations.

ITEM #	DESCRIPTION
182200	Straight, 1-1/2" (4 cm)
182205	Straight, 2-1/4" (5.5 cm)
182210	Curved, 1-3/8" (3.5 cm)

Extra Delicate Hemostatic Forceps

JACOBSON HEMOSTATIC FORCEPS



Pilling® Pattern, satin finish. These delicate forceps feature tips as fine as 0.8 mm and can be used in a number of microsurgical procedures.

ITEM #	DESCRIPTION
443500	Straight, 0.8 mm tip, 3-7/8" (10 cm)
443502	Curved, 0.8 mm tip, 3-7/8" (10 cm)
443505	Straight, 0.8 mm tip, 5-1/8" (13 cm)
443507	Curved, 0.8 mm tip, 5-1/8" (13 cm)
443508	Full curved, 0.8 mm tip, 4-7/8" (12.5 cm)
443510	Curved, 1.2 mm tip, 7-1/8" (18 cm)
443512	Full curved, 1 mm tip, 7-1/8" (18 cm)

FORCEPS AND CLAMPS

Extra Delicate Hemostatic Forceps

MICRO MOSQUITO FORCEPS



KMedic® Pattern, satin finish.

ITEM #	DESCRIPTION
KM36164	Straight, 1 mm tip, 5" (12.5 cm)
KM36165	Curved, serrated, extremely fine tips, 5" (12.5 cm)

PLASTI STATS® ADSON FORCEPS



ITEM #	DESCRIPTION
181824	Curved, 1/2" (12.5 mm) jaw serration, 5-1/2"(14 cm)

PLASTI STATS® COLLIER FORCEPS



ITEM #	DESCRIPTION
181804	Curved, 7-1/2" (19 cm)

FORCEPS AND CLAMPS

Extra Delicate Hemostatic Forceps

PLASTI STATS® CRILE HEMOSTATS



Full serrations.

ITEM #	DESCRIPTION
181800	Straight, 1-1/4" (32 mm) jaw, 5-3/4" (14.5 cm)
181802	Curved, 1-1/4" (32 mm) jaw, 5-1/2" (14 cm)

PLASTI STATS® KOCHER FORCEPS



ITEM #	DESCRIPTION
181832	Straight, 1 x 2 teeth, full serrations, 5-1/2" (14 cm)

PLASTI STATS® MOSQUITO FORCEPS



Full serrations.

ITEM #	DESCRIPTION
181810	Straight, 3/4" (2 cm) jaw, 4" (10 cm)
181812	Curved, 5/8" (1.5 cm) jaw, 4" (10 cm)
181818	Straight, 1/2" (12.5 mm) jaw, 4-3/4" (12 cm)
181820	Curved, 1/2" (12.5 mm) jaw, 4-5/8" (11.5 cm)
181814	Straight, 3/4" (2 cm) jaw, 5" (12.5 cm)
181816	Curved, 3/4" (2 cm) jaw, 5" (12.5 cm)
181806	Straight, 1" (2.5 cm) jaw, 5-1/2" (14 cm)
181808	Curved, 1" (2.5 cm) jaw, 5-1/2" (14 cm)



FORCEPS AND CLAMPS

Right Angle Clamps

CROUCH CLAMP

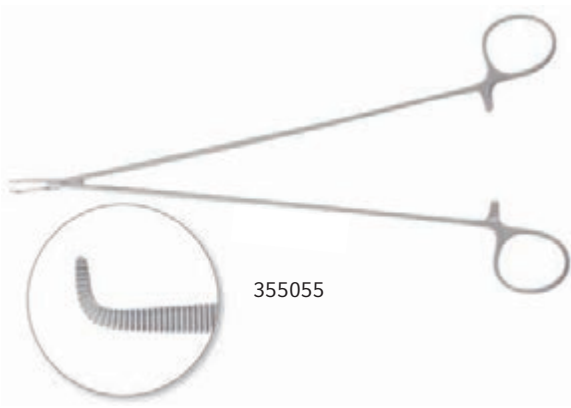

ITEM #	DESCRIPTION
355055	10-1/4" (26 cm)

DEBAKEY® RIGHT ANGLE FORCEPS

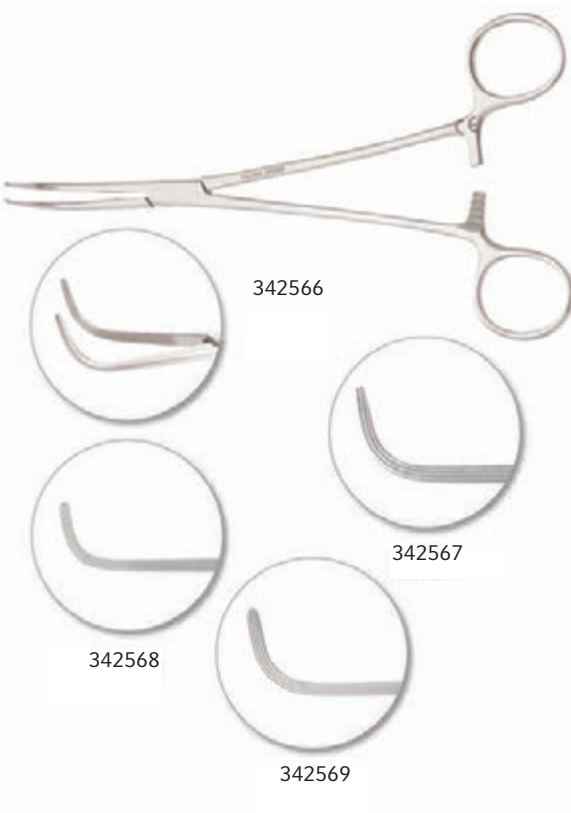

With full length longitudinal serrations and cross serrations at tip.

ITEM #	DESCRIPTION
342566	7-5/8" (19.5 cm)
342567	9" (23 cm)
342568	10-1/4" (26 cm)
342569	11-3/8" (29 cm)

FORCEPS AND CLAMPS

Right Angle Clamps

DIETHRICH RIGHT ANGLE CLAMPS

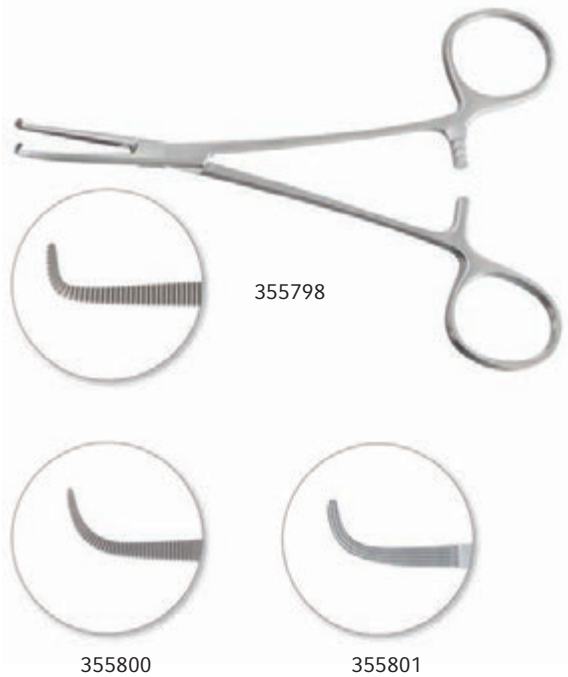

ITEM #	DESCRIPTION
355798	Serrated jaw, 5-3/8" (13.5 cm)
355799	Serrated jaw, 4-7/8" (12.5 cm)
355800	Serrated jaw 8 mm past angle, 7-1/4" (18.5 cm)
355801	Longitudinally serrated jaw 8 mm past angle, 7-1/4" (18.5 cm)

FINOCHIETTO THORACIC FORCEPS



A utility clamp for use as ligature carrier, hemostat or dissector. Particularly good in ligation during esophageal surgery. Blades have longitudinal serrations and holes for threading ligature.

ITEM #	DESCRIPTION
342615	Angled, longitudinal serrations, 1-1/8" (3 cm) tip length, 9-1/2" (24 cm)

FORCEPS AND CLAMPS

Right Angle Clamps

GEMINI FORCEPS



A more delicate modification of the Mixer Forceps. Slender, acutely curved jaws with full serrations.

ITEM #	DESCRIPTION
342596	7-1/4" (18.5 cm)
342597	9" (23 cm)
342598	11-1/8" (28.5 cm)

GRAY CYSTIC DUCT FORCEPS



ITEM #	DESCRIPTION
172550	Curved jaws and shafts. Set of two: 8-1/4" (21 cm) and 9-1/4" (23.5 cm)

HARRINGTON CLAMPS



Right angle jaw. Dull, non-glare finish stainless steel.

ITEM #	DESCRIPTION
342632	Heavy construction, longitudinal serrations, 1-1/2" (4 cm) tip length, 12-3/8" (31.5 cm)
342633	Light construction, longitudinal serrations, 1-1/2" (4 cm) tip length, 12-3/8" (31.5 cm)

FORCEPS AND CLAMPS

Right Angle Clamps

JACKSON TRACHEAL HEMOSTAT



ITEM #	DESCRIPTION
514480	Acutely curved, 5-3/8" (13.5 cm)

KANTROWITZ FORCEPS

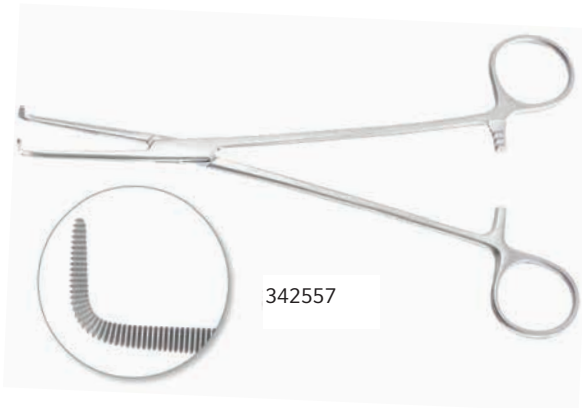

True right angle forceps with cross serrated jaws. Useful for grasping and dissecting in thoracic, vascular and general surgery.

ITEM #	DESCRIPTION
342557	Serrated, 3/4" (2 cm) tip length, 2 mm tip width, 7-7/8" (20 cm)
342558	Serrated, 9-1/2" (24 cm)
342559	Serrated, 3/4" (2 cm) tip length, 2 mm tip width, 10-5/8" (27 cm)



FORCEPS AND CLAMPS

Right Angle Clamps

LAHEY DISSECTING FORCEPS



ITEM #	DESCRIPTION
496105	Longitudinal serrations, 2.4 mm tip, 7-7/8" (20 cm)
496110	Horizontal serrations, 44 mm jaw, 2.4 mm tip, 7-3/4" (19.5 cm)
496111	Longitudinal serrations, 46 mm jaw, 2.5 mm tip, 7-3/4" (19.5 cm)

LAHEY GALL DUCT FORCEPS, SLENDER BLADES

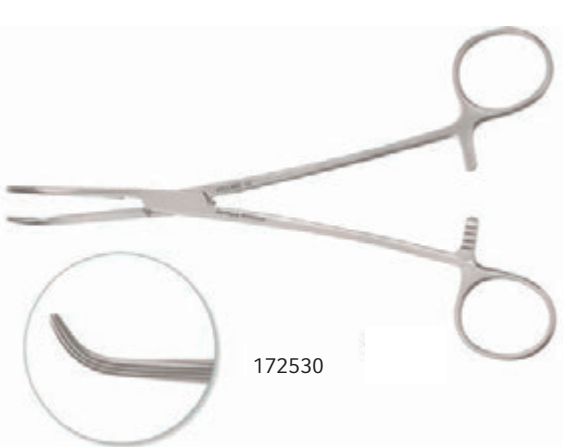

ITEM #	DESCRIPTION
172530	Longitudinal serrations, 7-1/2" (19 cm)
172531	Standard serrations, 7-1/2" (19 cm)
172532	Longitudinal serrations, 8-7/8" (22.5 cm)

FORCEPS AND CLAMPS

Right Angle Clamps

LOWER GALL DUCT FORCEPS



ITEM #	DESCRIPTION
172525	Short jaws, fully curved, longitudinal serrations, 7-1/2" (19 cm)

MEEKER HEMOSTATIC DISSECTING FORCEPS

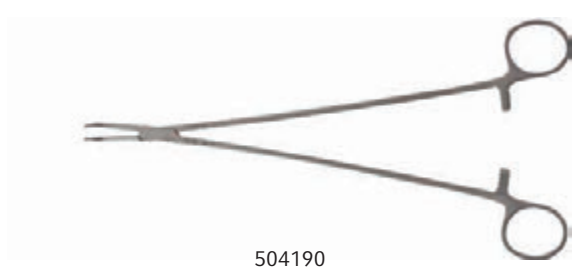

ITEM #	DESCRIPTION
540150	90 degree-angled, serrated, 23 mm jaw, 1.8 mm tip, 6-3/8" (16 cm)
504190	90 degree-angled, serrated, 28 mm jaw, 1.8 mm tip, 10-5/8" (27 cm)

MACQUIGG-MIXTER FORCEPS



An excellent general purpose forceps and bronchus clamp. Longitudinally serrated jaws, right-angle tip.

ITEM #	DESCRIPTION
342611	Curved, longitudinal serrations, 1-5/8" (4 cm) tip length, 8-5/8" (22 cm)

FORCEPS AND CLAMPS

Right Angle Clamps

MIXTER THORACIC FORCEPS



Regular model. Available with DeBakey®-type jaw or standard serrated jaw, 3/4" (2 cm) long.

ITEM #	DESCRIPTION
342603	Half curved, serrated, 5/8" (1.5 cm) tip length, 2.3 mm tip width, 9-1/8" (23 cm)
342600	Curved, DeBakey®-type jaw, 1" (2.5 cm) tip length, 2.8 mm tip width, 9-1/4" (23.5 cm)
342601	Strongly curved, serrated, 3/4" (2 cm) tip length, 8-3/4" (22 cm)

MIXTER CLAMPS

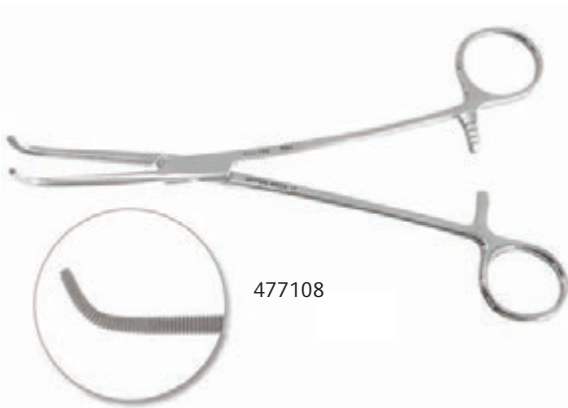

ITEM #	DESCRIPTION
477108	40 degree-angled, fully serrated, 50 mm jaw, 3 mm tip, 7-3/4" (19.5 cm)

MIXTER DISSECTING FORCEPS

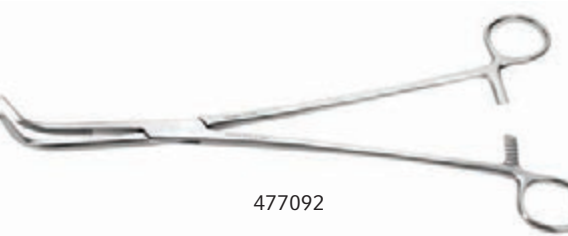

Two-thirds serrations.

ITEM #	DESCRIPTION
477091	26 mm jaw, 2 mm tip, 7-1/4" (18.5 cm)
477092	40 mm jaw, 2.2 mm tip, 9" (23 cm)
477093	55 mm jaw, 2.4 mm tip, 11" (28 cm)

FORCEPS AND CLAMPS

Right Angle Clamps

MIXTER FORCEPS



ITEM #	DESCRIPTION
KM36566	Fully curved, serrated, 9" (23 cm)

MIXTER GALL DUCT FORCEPS



Acutely curved jaws. Full serrations run entire length of jaw.

ITEM #	DESCRIPTION
172500	6-1/4" (16 cm)
172503	7-1/8" (18 cm)
172506	8-3/4" (22 cm)

PEDIATRIC MIXTER DISSECTING FORCEPS

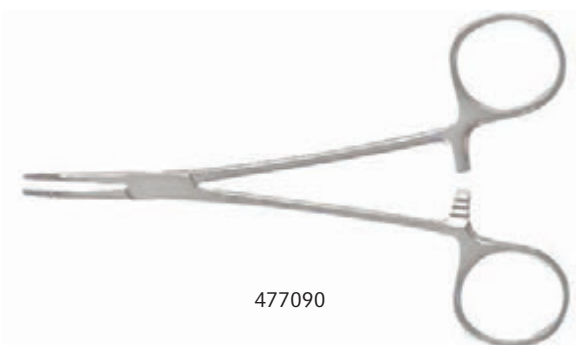

Weck® Pattern, bright finish.

ITEM #	DESCRIPTION
477090	24 mm jaw, 2 mm tip, 5-1/4" (13.5 cm)

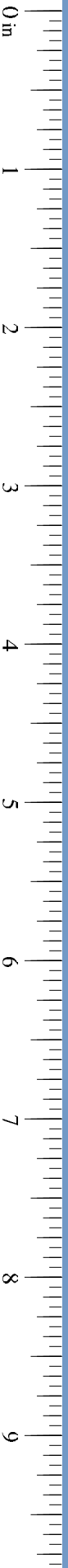

FORCEPS AND CLAMPS

Right Angle Clamps

MIXTER "PEDI" GALL DUCT FORCEPS



Pilling® Pattern, satin finish.

ITEM #	DESCRIPTION
172495	Delicate, 5-1/8" (13 cm)

RIENHOFF SWAN-NECK CLAMP



A double-curved forceps with delicately rounded tips.

ITEM #	DESCRIPTION
342625	Serrated, 10-5/8" (27 cm)

ROOS SCALENECTOMY FORCEPS



Designed to give a secure hold on the scalene muscle during scaleneotomy.

ITEM #	DESCRIPTION
342575	Right angle, longitudinal serrations, 1/2" (1.5 cm) tip length, 1.5 mm tip width, 11" (28 cm)

FORCEPS AND CLAMPS

Right Angle Clamps

RUMEL THORACIC FORCEPS



Furnished with DeBakey®-type jaw or standard serrated jaws. In addition to being one of the more popular thoracic artery forceps, they are especially suited for passing tapes around the cava or pulmonary artery in open heart surgery.

ITEM #	DESCRIPTION
342501	A curved, DeBakey® jaw, 2-3/4" (7 cm) tip length, 9-5/8" (24.5 cm)
342504	D curved, DeBakey® jaw, 1-1/8" (3 cm) tip length, 2.8 mm tip width, 9-3/4" (25 cm)
342511	A curved, serrated, 1/2" (1.5 cm) tip length, 2.4 mm tip width, 9-3/8" (24 cm)
342513	C curved, serrated, 3/4" (2 cm) tip length, 2 mm tip width, 9-5/8" (24.5 cm)
342514	D curved, serrated, 1" (2.5 cm) tip length, 2.4 mm tip width, 9" (23 cm)
342533	Child size, fully curved, standard serrated, 2 mm tip width, 7-7/8" (20 cm)

SAWTELL HEMOSTATIC FORCEPS

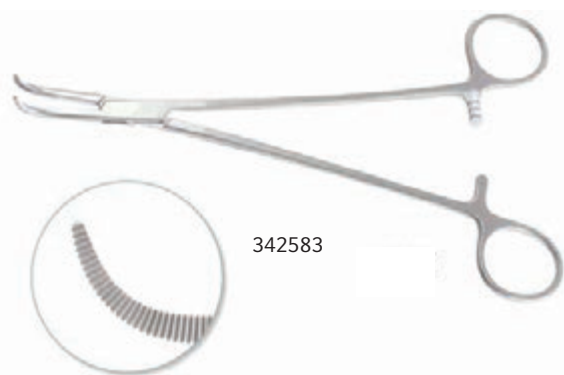

ITEM #	DESCRIPTION
342583	Full curved, heavy tips, 7-1/4" (18.5 cm)



FORCEPS AND CLAMPS

Right Angle Clamps

STOREY HEMOSTATIC FORCEPS

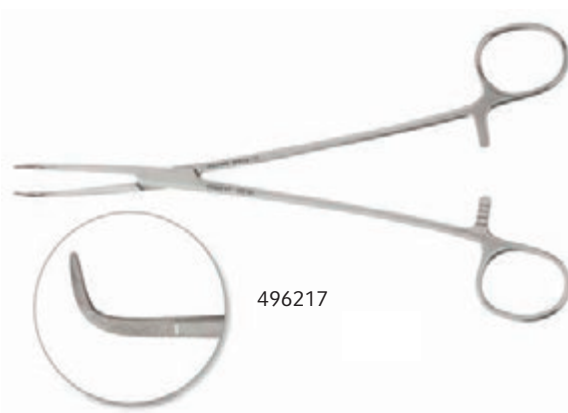

33 mm jaw with cross serrations.

ITEM #	DESCRIPTION
496215	Slightly curved, 8-3/4" (22 cm)
496216	Strongly curved, 8-5/8" (22 cm)
496217	Right angle, 8-3/8" (21.5 cm)

WESTPHAL DISSECTING FORCEPS



Longitudinal serrations, narrow tip.

ITEM #	DESCRIPTION
496112	Angled, 7-7/8" (20 cm)

FORCEPS AND CLAMPS

Right Angle Clamps

WILLAUER FORCEPS



Lightweight full curved, longitudinally serrated jaws.

ITEM #	DESCRIPTION
342580	2" (5 cm) tip length, 9-1/2" (24 cm)

Gastrointestinal Forceps and Clamps

ADAIR-ALLIS INTESTINAL TISSUE FORCEPS

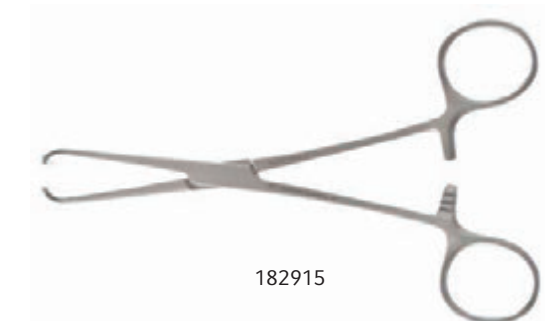

ITEM #	DESCRIPTION
182915	9 x 10 Teeth, 6-1/4" (16 cm)

ALLEN INTESTINAL CLAMPS

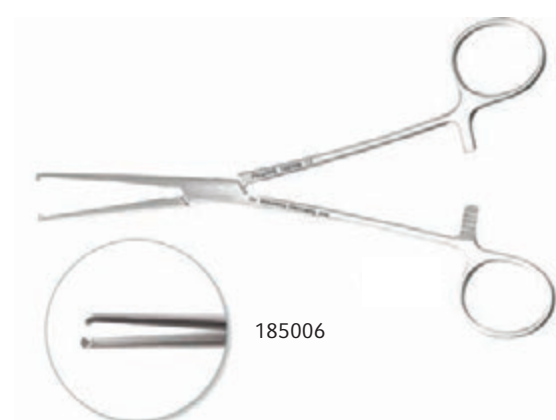

Longitudinal serrations, 1 x 2 teeth.

ITEM #	DESCRIPTION
185005	Jaws 3-3/4" (9.5 cm), 9-1/2" (24 cm)
185006	Jaws 2-3/8" (6 cm), 8" (20.5 cm)
185010	Pediatric size, delicate, jaws 2-1/8" (5.5 cm), 6-1/4" (16 cm)

FORCEPS AND CLAMPS

Gastrointestinal Forceps and Clamps

ALLIS DELICATE TISSUE FORCEPS



Weck® Pattern, bright finish, 6-1/8" (15.5 cm).

ITEM #	DESCRIPTION
541100	2 x 3 teeth, 3.8 mm tip
541120	Straight, delicate, 3 x 4 teeth, 4 mm tip

ALLIS TISSUE FORCEPS

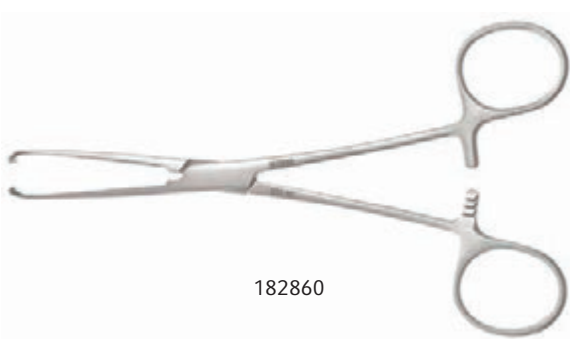

Pilling® Pattern, satin finish.

ITEM #	DESCRIPTION
182795	3 x 4 teeth, 6" (15 cm)
182850	4 x 5 teeth, 6" (15 cm)
182860	5 x 6 teeth, 6" (15 cm)
182870	5 x 6 teeth, 7-1/2" (19 cm)
182875	5 x 6 teeth, 9" (23 cm)
182880	4 x 5 teeth, 5-3/4" (14.5 cm)

ALLIS TISSUE FORCEPS

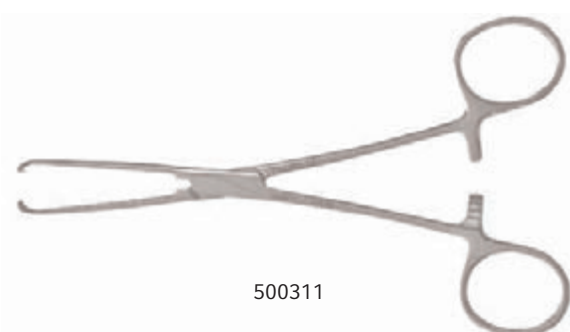

Weck® Pattern, bright finish.

ITEM #	DESCRIPTION
541094	3 x 4 teeth, 5" (12.5 cm)
500310	3 x 4 teeth, 6-1/8" (15.5 cm)
500311	4 x 5 teeth, 6-1/8" (15.5 cm)
500312	5 x 6 teeth, 6-1/8" (15.5 cm)
500316	5 x 6 teeth, 7-1/2" (19 cm)

FORCEPS AND CLAMPS

Gastrointestinal Forceps and Clamps

JUDD-ALLIS INTESTINAL FORCEPS

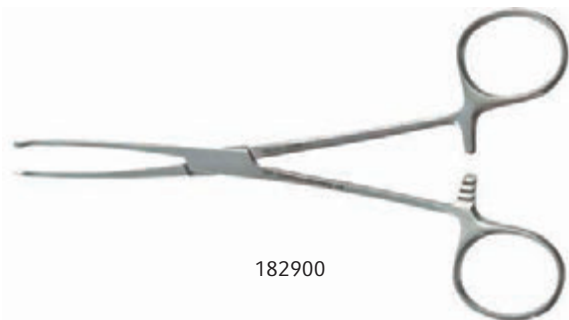

ITEM #	DESCRIPTION
182900	3 x 4 teeth, 6" (15 cm)
182905	3 x 4 teeth, 7-1/4" (18.5 cm)

LOCKWOOD-ALLIS INTESTINAL TISSUE FORCEPS

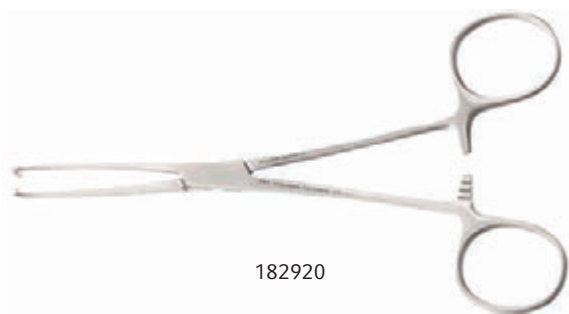

ITEM #	DESCRIPTION
182920	Light model, flattened jaws, 5 x 6 teeth, 6-1/4" (16 cm)

THOMS-ALLIS TISSUE AND TRACTION FORCEPS

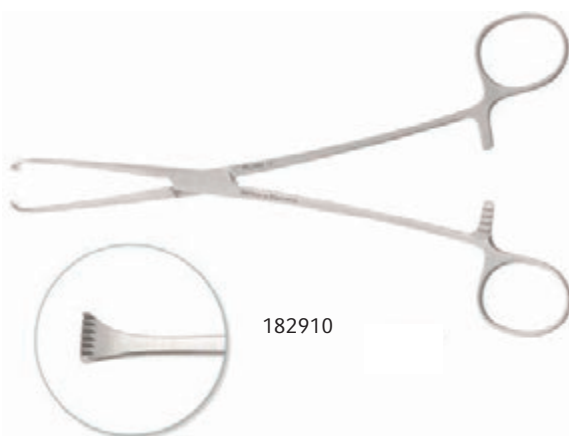

ITEM #	DESCRIPTION
182910	6 x 7 teeth, 8" (20.5 cm)



FORCEPS AND CLAMPS

Gastrointestinal Forceps and Clamps

WILLAUER-ALLIS TISSUE FORCEPS

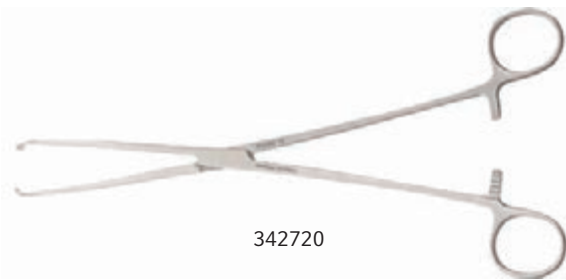

Extra-long, springy, Allis-type forceps with 5 x 6 teeth. Dull, non-glare finish stainless steel.

ITEM #	DESCRIPTION
342720	10" (25.5 cm)
342721	11-1/4" (28.5 cm)

BABCOCK TISSUE FORCEPS

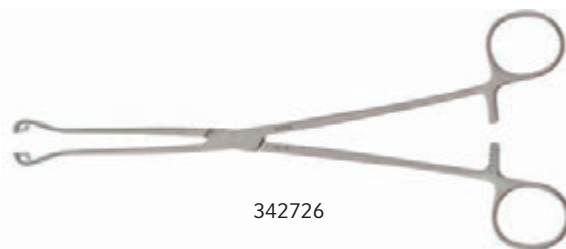

Pilling® Pattern, satin finish.

ITEM #	DESCRIPTION
183010	6-1/4" (16 cm)
183020	7-7/8" (20 cm)
342725	Serrated, 9-1/2" (24 cm)
342726	Serrated, 9-1/2" (24 cm)

BABCOCK TISSUE FORCEPS



Weck® Pattern, bright finish.

ITEM #	DESCRIPTION
500399	5.8 mm tip, 5-3/4" (14.5 cm)
500400	8.3 mm tip, 6-3/8" (16 cm)
500402	10 mm tip, 7-7/8" (20 cm)

FORCEPS AND CLAMPS

Gastrointestinal Forceps and Clamps

BABCOCK TISSUE FORCEPS

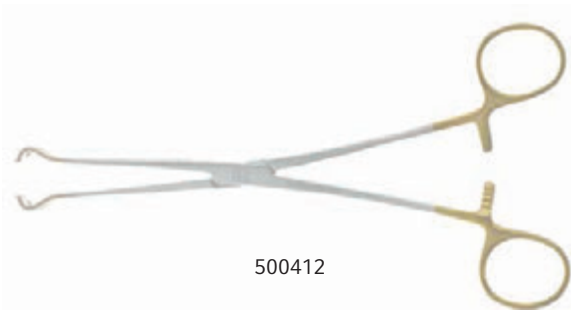

Tungsten carbide jaw tips.

ITEM #	DESCRIPTION
500410	3/8" (9.5 mm) tip, 6-1/2" (16.5 cm), TC
500412	7/16" (11 mm) tip, 7-7/8" (20 cm), TC

BAINBRIDGE FORCEPS

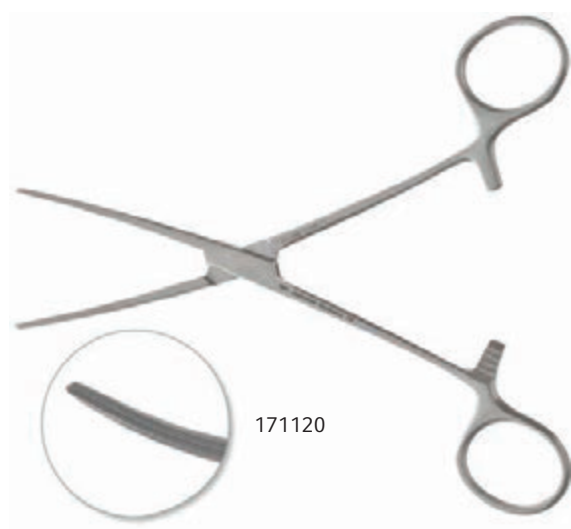

Pilling® Pattern, satin finish. Slender blades longitudinally serrated.

ITEM #	DESCRIPTION
171117	Straight, 7-1/4" (18.5 cm)
171120	Curved, 6-3/4" (17 cm)
171122	Curved, 7-1/4" (18.5 cm)



FORCEPS AND CLAMPS

Gastrointestinal Forceps and Clamps

DEBAKEY® BAINBRIDGE CLAMPS



With narrow DeBakey®-type jaws.

ITEM #	DESCRIPTION
353560	Straight, 40 x 2.4 mm jaws, 7" (18 cm)
353562	Straight, 80 x 2.8 mm jaws, 7-7/8" (20 cm)
353565	Curved, 60 x 2.4 mm jaws, 7" (18 cm)

BEST COLON CLAMP

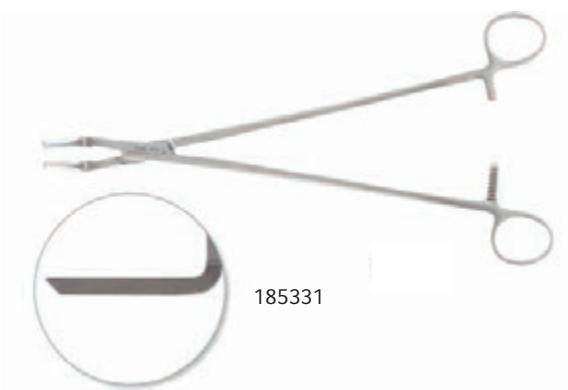

Right angle design for open anastomosis. Strong crushing jaws.

ITEM #	DESCRIPTION
185331	2-5/8" (6.5 cm) jaw size, 10-5/8" (27 cm)

FORCEPS AND CLAMPS

Gastrointestinal Forceps and Clamps

BLAKE GALLSTONE GRASPING FORCEPS

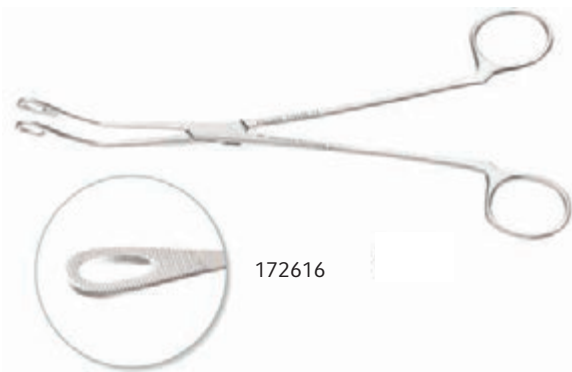

Pilling® Pattern, satin finish.

ITEM #	DESCRIPTION
172616	Curved, serrated, 8" (20.5 cm)

CYSTIC DUCT CATHETER CLAMPS



For open cholangiography.

ITEM #	DESCRIPTION
172570	Accepts 4 Fr. catheter, 7-1/2" (19 cm)
172571	Accepts 6 Fr. catheter, 7-1/2" (19 cm)



FORCEPS AND CLAMPS

Gastrointestinal Forceps and Clamps

DEBAKEY® THORACIC DISSECTING FORCEPS

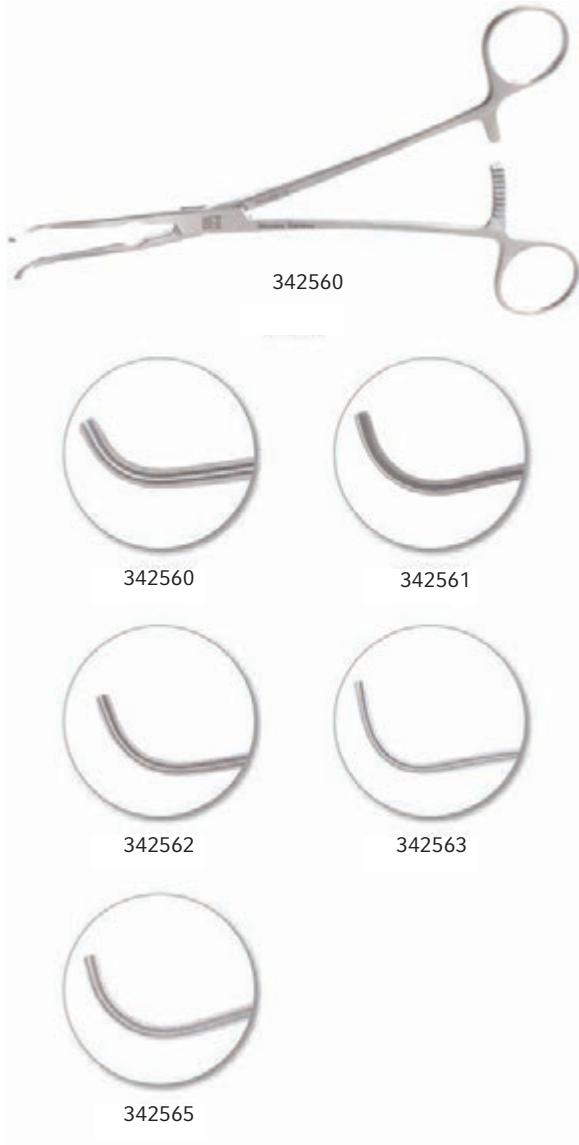

DeBakey®-type jaws. The jaws are narrowed and thinned to a minimum size and double-curved. This provides a lightweight, sure-holding forceps for dissecting and passing tapes and ligatures around vessels.

ITEM #	DESCRIPTION
342560	C curved, 3/8" (1 cm) tip length, 8-1/8" (20.5 cm)
342561	D curved, 1/2" (1.5 cm) tip length, 2.8 mm tip width, 8-1/4" (21 cm)
342562	C curved, 5/8" (1.5 cm) tip length, 2.8 mm tip width, 9-5/8" (24.5 cm)
342563	D curved, 7/8" (2 cm) tip length, 9-1/2" (24 cm)
342565	D curved, 3/4" (2 cm) tip length, 10-1/4" (26 cm)



FORCEPS AND CLAMPS

Gastrointestinal Forceps and Clamps

DENNIS ANASTOMOSIS CLAMP



ITEM #	DESCRIPTION
185030	54 mm jaws, 9-1/4" (23.5 cm)

DESJARDIN GALLSTONE GRASPING FORCEPS

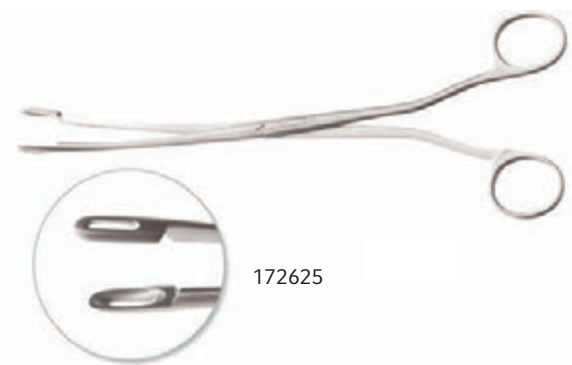

ITEM #	DESCRIPTION
172625	9-1/4" (23.5 cm)

DOYEN INTESTINAL CLAMPS

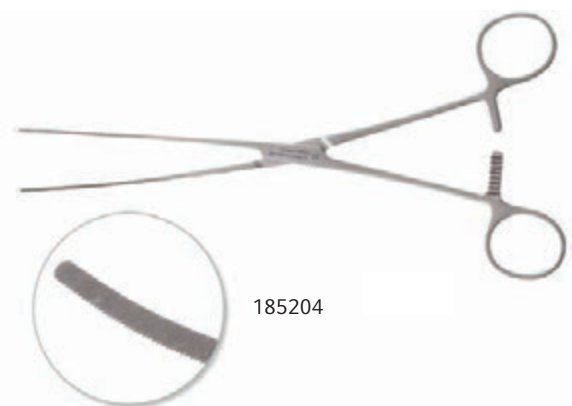

Soft blades, diagonal serrations.

ITEM #	DESCRIPTION
185202	Straight, 9-1/8" (23 cm)
185204	Curved, 9" (23 cm)

FORCEPS AND CLAMPS

Gastrointestinal Forceps and Clamps

HAYES ANTERIOR RESECTION CLAMPS

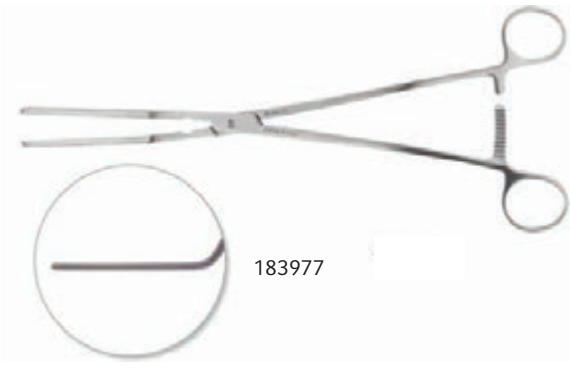

70 degree-angled, 1 x 2 DeBakey® Jaws, angular shafts.

ITEM #	DESCRIPTION
183975	2-3/8" (6 cm) jaws, 9-7/8" (25 cm)
183977	3-1/8" (8 cm) jaws, 10-1/2" (26.5 cm)

KLINTMALM™ LIVER TRANSPLANT CLAMPS

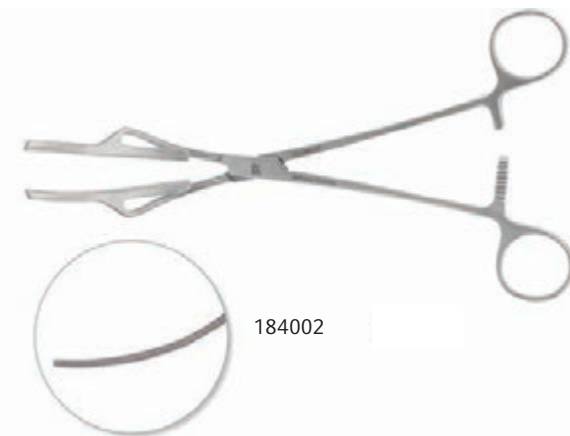

The KLINTMALM™ Liver Transplant Clamp is designed to securely occlude the suprahepatic inferior vena cava of the recipient during anastomosis of the donor liver.

- Unique "teething" design of a single row against a double row of teeth helps prevent slippage and scissoring of the jaw.
- An even-parallel closure of the jaw helps prevent blood seepage and helps minimize the risk of the vena cava slipping from the clamp.
- Jaw curvature is designed to meet the anatomical requirements of the upper abdomen and to reduce trauma to the liver.

A standard vascular clamp on the cuff of the vena cava and diaphragm may not always properly close due to the amount of tissue in the clamp. The use of a standard vascular clamp may result in clamp insecurity and slippage leading to the possible retraction of the vena cava into the diaphragm, and visual obstruction caused by pooling blood.

ITEM #	DESCRIPTION
184001	Small 2-1/2" (6.5 cm) jaw, 7-1/8" (18 cm)
184002	Medium 3-1/8" (8 cm) jaw, 8-3/8" (21.5 cm)
184003	Large 3-3/8" (8.5 cm) jaw, 9-7/8" (25 cm)

FORCEPS AND CLAMPS

Gastrointestinal Forceps and Clamps

KOCHER INTESTINAL CLAMPS

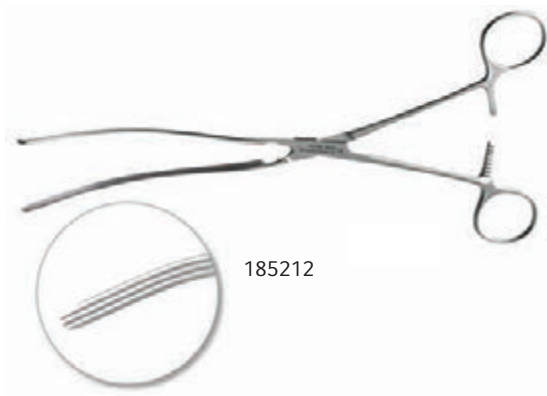

Soft blades, longitudinal serrations.

ITEM #	DESCRIPTION
185210	Straight, 10" (25.5 cm)
185212	Curved, 9-7/8" (25 cm)
185214	Straight, 10-3/4" (27.5 cm)

LELAND JONES CLAMPS

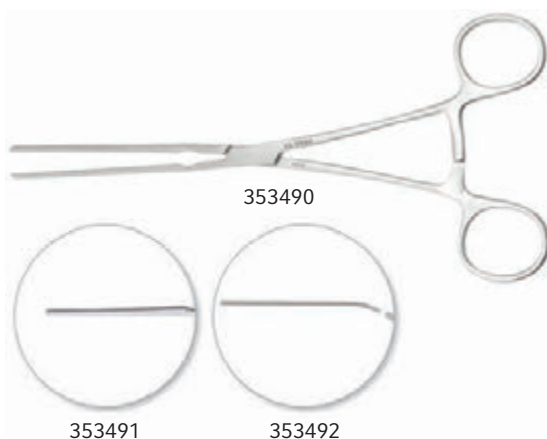

Delicate DeBakey® Jaws, 2.4 mm wide. LIFE-LOK® Box Lock. Versatile clamps which have been found useful in small bowel procedures.

ITEM #	DESCRIPTION
353490	Straight, 8-1/8" (20.5 cm)
353491	Angled 15 degrees, 8-1/8" (20.5 cm)
353492	Angled 30 degrees, 8" (20.5 cm)

MIXTER FORCEPS



Long model. Very useful for deep dissection and as a bronchus clamp.

ITEM #	DESCRIPTION
342606	Strongly curved, serrated (3 cm) tip length, 10-3/4" (27.5 cm)
342605	Strongly curved, DeBakey® Jaw, 1-3/8" (3.5 cm) tip length, 11" (28 cm)



FORCEPS AND CLAMPS

Gastrointestinal Forceps and Clamps

MAYO (GUYON) VESSEL CLAMP

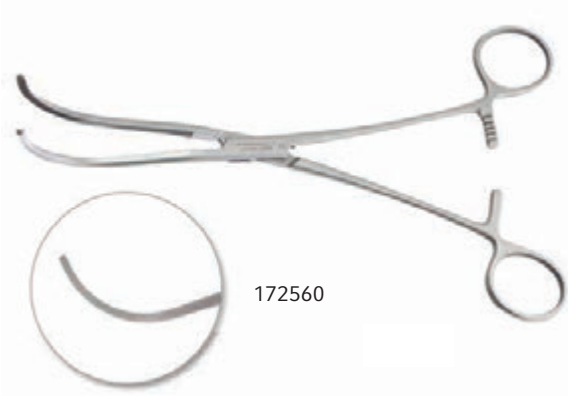

ITEM #	DESCRIPTION
172560	9-1/4" (23.5 cm)

MAYO-ROBSON INTESTINAL CLAMPS

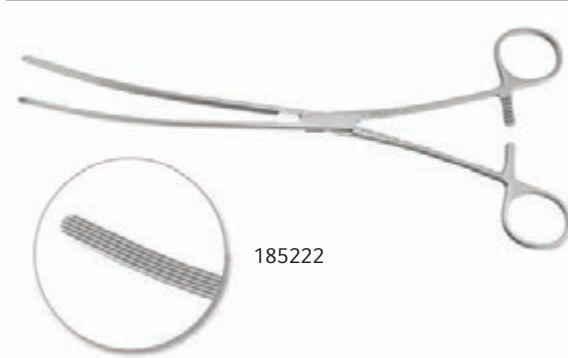

Longitudinal serrations.

ITEM #	DESCRIPTION
185220	Straight, 10-1/4" (26 cm)
185222	Curved, 10" (25.5 cm)

FORCEPS AND CLAMPS

Gastrointestinal Forceps and Clamps

PENNINGTON FORCEPS

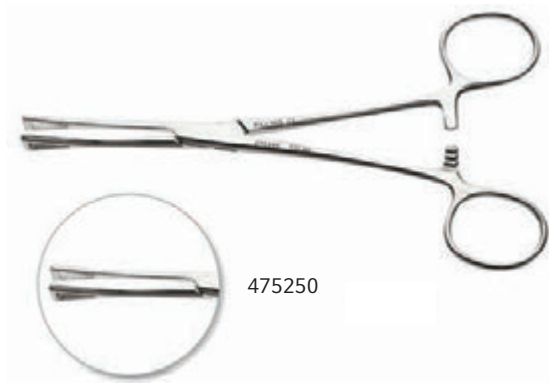

ITEM #	DESCRIPTION
475250	Serrated, triangular, 14 x 11 mm jaw, 6-1/8" (15.5 cm)
616370	Serrated, triangular, 16 x 12.5 mm jaw, 8-1/4" (21 cm)

PILLING® GUT AND COLON CLAMPS

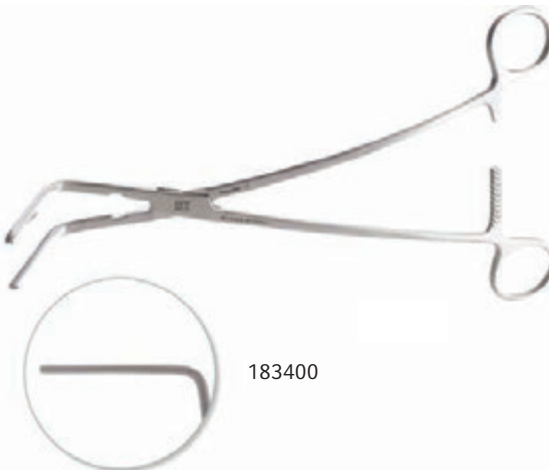

90 degree angled, 1 x 2 DeBakey®-type Jaws, curved shafts.

ITEM #	DESCRIPTION
183400	2-3/4" (7 cm) jaws, 9-3/8" (24 cm)
183410	3-5/8" (9 cm) jaws, 9-5/8" (24.5 cm)

FORCEPS AND CLAMPS

Gastrointestinal Forceps and Clamps

STONE INTESTINAL CLAMPS



Handle may be used at any angle. Narrow longitudinally serrated blades. Set consists of 2 clamps with tip locks and 2 applying forceps.

ITEM #	DESCRIPTION
185402	Set. With 4-3/8" (11 cm) length clamps
185404	Clamp with tip lock, 3-3/8" (8.5 cm)

STRELINGER RIGHT ANGLE CLAMP

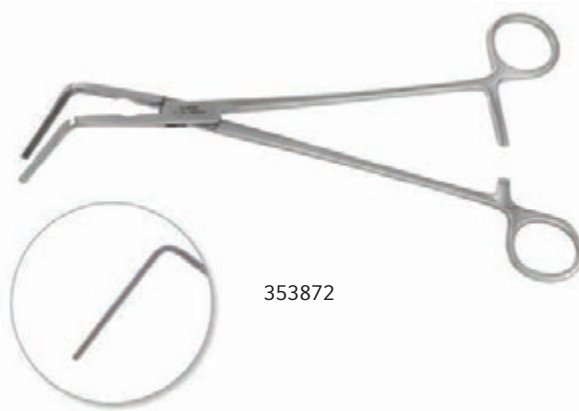

ITEM #	DESCRIPTION
353872	Large size, 3-1/4" (8.5 cm) DeBakey®-type jaws angled 90 degrees, 9-5/8" (24.5 cm)

SCISSORS

Bandage Scissors and Shears

ESMARCH BANDAGE SCISSORS



One large finger ring.

ITEM #	DESCRIPTION
142425	7-3/4" (19.5 cm)

ESMARCH PLASTER SHEARS



ITEM #	DESCRIPTION
463885	7-7/8" (20 cm)

HERCULES PLASTER SCISSORS



For lightweight plaster or aluminum casts.

ITEM #	DESCRIPTION
KM31834	Angled, one blade serrated, 7-1/2" (19 cm)



SCISSORS

Bandage Scissors and Shears

HI-LEVEL BANDAGE SCISSORS



The delicate offset shanks provide better leverage. The fine knob slides easily under finger and toe bandages.

ITEM #	DESCRIPTION
KM31792	Shanks angled on side, one serrated blade, 5-1/2" (14 cm)

KMEDIC® UTILITY SHEARS



Effective for cloth or cotton wadding. One smooth and one serrated blade.

ITEM #	DESCRIPTION
KM11202	Ring handles, 7-1/2" (19 cm)
KM31836	8-1/4" (21 cm)

KNOWLES BANDAGE SCISSORS



For finger and toe bandages.

ITEM #	DESCRIPTION
KM31804	Straight, one serrated blade, 5-1/2" (14 cm)

SCISSORS

Bandage Scissors and Shears

LISTER BANDAGE SCISSORS



ITEM #	DESCRIPTION
KM31680	4-1/2" (11.5 cm)

LISTER BANDAGE SCISSORS



Pilling® Pattern, satin finish.

ITEM #	DESCRIPTION
142415	5-3/4" (14.5 cm)
142420	7-1/4" (18.5 cm)
142422	8" (20.5 cm)

LISTER BANDAGE SCISSORS



Weck® Pattern, bright finish.

ITEM #	DESCRIPTION
463810	5-3/4" (14.5 cm)
463830	7-1/4" (18.5 cm)





SCISSORS

Bandage Scissors and Shears

LISTER BANDAGE SCISSORS



One large finger ring.

ITEM #	DESCRIPTION
463840	8" (20.5 cm)

MOLESKIN SCISSORS



One blade serrated.

ITEM #	DESCRIPTION
KM69820	Straight, 7" (18 cm)
KM69824	Curved, 7-1/2" (19 cm)

SCISSORS

Bandage Scissors and Shears

MAKI™ SCISSORS



Uniquely designed teeth to grip bottle caps, needles, tubing.

ITEM #	DESCRIPTION
463820	5-3/4" (14.5 cm)

UNIVERSAL SHEARS



Stainless steel, comfortable polymer handles, serrated.

ITEM #	DESCRIPTION
142452	7-1/2" (19 cm)

UTILITY SCISSORS



With autoclavable plastic finger rings.

ITEM #	DESCRIPTION
KM31832	Lister-type, one serrated blade, 5-3/4" (14.5 cm)

SCISSORS

Stitch and Suture Removal Scissors

HILL STITCH SCISSORS



ITEM #	DESCRIPTION
KM35084	Curved, 4-3/8" (11 cm)

LITTAUER STANDARD SUTURE SCISSORS



ITEM #	DESCRIPTION
142325	5-1/2" (14 cm)

LITTAUER STITCH SCISSORS



ITEM #	DESCRIPTION
KM35120	Straight, 5-1/2" (14 cm)

SCISSORS

Stitch and Suture Removal Scissors

LITTLER STITCH SCISSORS



ITEM #	DESCRIPTION
KM35078	Curved, 4-5/8" (11.5 cm)

NORTHBENT STITCH SCISSORS



ITEM #	DESCRIPTION
KM35104	Curved on side, 4-3/4" (12 cm)





SCISSORS

Stitch and Suture Removal Scissors

SHORTBENT STITCH SCISSORS



ITEM #	DESCRIPTION
KM35080	Curved on side, delicate, 3-1/2" (9 cm)

SPENCER SCISSORS



Pilling® Pattern, satin finish. Very delicate for fine sutures.

ITEM #	DESCRIPTION
142312	5" (12.5 cm)

SCISSORS

Stitch and Suture Removal Scissors

SPENCER STITCH SCISSORS



KMedic® Pattern, satin finish. Delicate, straight.

ITEM #	DESCRIPTION
KM35068	3-1/2" (9 cm)
KM35092	4-3/4" (12 cm)

SPENCER STITCH SCISSORS



Weck® Pattern, bright finish.

ITEM #	DESCRIPTION
520135	Slightly curved, 20 mm blades, 3-1/2" (9 cm)
520140	Straight, serrated, 30 mm blades, 5" (12.5 cm)





SCISSORS

Stitch and Suture Removal Scissors

SUTURE REMOVAL SCISSORS



Weck® Pattern, bright finish.

ITEM #	DESCRIPTION
056120	Curved, pointed, 22 mm blades, 4-3/4" (12 cm)

Wire Cutting Scissors

BANTAM WIRE CUTTING SCISSORS



Serrated 18 mm blades.

ITEM #	DESCRIPTION
520150	Straight, 4-3/8" (11 cm)
520152	Curved, 4" (10 cm)

SCISSORS

Wire Cutting Scissors

HEATH SUTURE AND WIRE CUTTING SCISSORS



ITEM #	DESCRIPTION
520120	Curved sideways, serrated, 23 mm blades, 6" (15 cm)

ROGER WIRE CUTTING SCISSORS



Weck® Pattern, bright finish.

ITEM #	DESCRIPTION
520130	One serrated blade, 15 mm blades angled sideways, 5" (12.5 cm)

WIRE SCISSORS



Pilling® Pattern, satin finish. Angular with notch for wire.

ITEM #	DESCRIPTION
142515	Stainless steel blades, one serrated, 5" (12.5 cm)
142518	TC blades, 5" (12.5 cm)

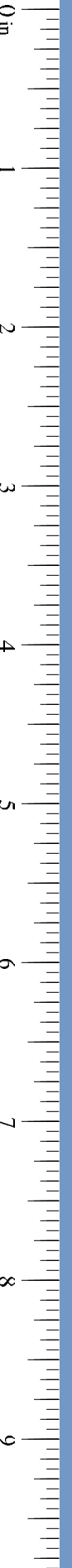

SCISSORS

Wire Cutting Scissors

WIRE CUTTING SCISSORS



KMedic® Pattern, satin finish.

ITEM #	DESCRIPTION
KM35200	Angular carbide, one serrated blade, 4-3/4" (12 cm), TC

VERNON WIRE SCISSORS

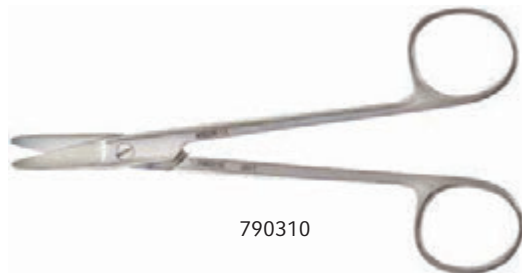

Straight, serrated blades.

ITEM #	DESCRIPTION
790310	32 mm blades, 5-3/4" (14.5 cm)
790315	42 mm blades, 7-1/2" (19 cm)

Operating Scissors

DELICATE OPERATING SCISSORS



Sharp/Blunt.

ITEM #	DESCRIPTION
460180	Straight, 5" (12.5 cm)

SCISSORS

Operating Scissors

OPERATING SCISSORS, B/B



Blunt/Blunt, stainless steel.

ITEM #	DESCRIPTION
460165	Straight, 5" (12.5 cm)
460219	Curved, 5-1/2" (14 cm)
460170	Straight, 5-3/4" (14.5 cm)
460179	Straight, 6" (15 cm)
460177	Straight, 7" (18 cm)

OPERATING SCISSORS, S/B



Sharp/Blunt, stainless steel.

ITEM #	DESCRIPTION
460100	Straight, 4-3/4" (12 cm)
460105	Straight, 5" (12.5 cm)
460110	Straight, 5-1/2" (14 cm)
460220	Curved, 5-1/2" (14 cm)
460175	Straight, 6" (15 cm)
460115	Straight, 6-3/4" (17 cm)

OPERATING SCISSORS, S/S



Sharp/Sharp, stainless steel.

ITEM #	DESCRIPTION
460245	Curved, 5-1/2" (14 cm)
460135	Straight, 5" (12.5 cm)
460140	Straight, 5-1/2" (14 cm)

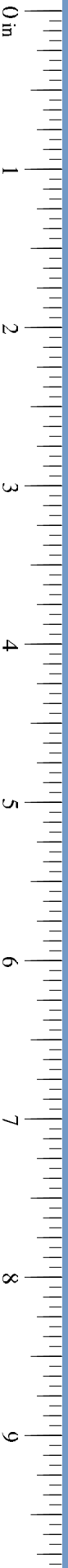

SCISSORS

Operating Scissors

OPERATING SCISSORS, TC



5-1/2" (14 cm), TC.

ITEM #	DESCRIPTION
464500	Sharp/Blunt
464502	Sharp/Sharp

OPERATING SCISSORS



Pilling® Pattern, satin finish.

ITEM #	DESCRIPTION
141146	Sharp/Blunt, straight, 5-1/2" (14 cm)
141106	Sharp/Sharp, straight, 5-3/4" (14.5 cm)

Mayo-Type Scissors

MAYO BEVELED BLADE SCISSORS



ITEM #	DESCRIPTION
141310	Straight, 5-3/4" (14.5 cm)
141315	Curved, 5-3/4" (14.5 cm)
141312	Straight, 6-3/4" (17 cm)
141317	Curved, 6-3/4" (17 cm)

SCISSORS

Mayo-Type Scissors

MAYO ROUND SURFACE BLADE SCISSORS



ITEM #	DESCRIPTION
141332	Straight, 6-3/4" (17 cm)

MAYO DISSECTING SCISSORS



Weck® Pattern, bright finish.

ITEM #	DESCRIPTION
460410	Curved, 43 mm blades, 5-1/2" (14 cm)
460400	Straight, 43.5 mm blades, 5-5/8" (14.5 cm)
460420	Straight, 51.5 mm blades, 6-3/4" (17 cm)
460430	Curved, 49.5 mm blades, 6-3/4" (17 cm)
460620	Straight, 64 mm blades, 8-3/4" (22 cm)
460630	Curved, 64 mm blades, 8-3/4" (22 cm)

MAYO DISSECTING SCISSORS



Weck® Pattern, bright finish, lightweight, 6-1/2" (16.5 cm).

ITEM #	DESCRIPTION
460460	Straight
460461	Curved

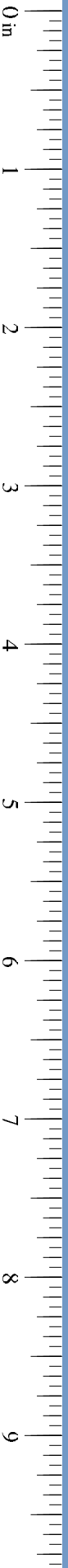

SCISSORS

Mayo-Type Scissors

MAYO DISSECTING SCISSORS, TC



Pilling® Pattern, satin finish. Beveled blade.

ITEM #	DESCRIPTION
142220	Curved, 5-1/2" (14 cm), TC
142235	Curved, 9" (23 cm), TC
142237	Straight, 9" (23 cm), TC

MAYO DISSECTING SCISSORS, TC



Weck® Pattern, bright finish. Round blade.

ITEM #	DESCRIPTION
464605	Curved, 5-3/4" (14.5 cm), TC
464615	Curved, 6-1/2" (16.5 cm), TC
464600	Straight, 5-3/4" (14.5 cm), TC
464610	Straight, 6-1/2" (16.5 cm), TC

SCISSORS

Mayo-Type Scissors

MAYO NOBLE SCISSORS



6-1/2" (16.5 cm).

ITEM #	DESCRIPTION
460600	Straight
460601	Curved

MAYO-HARRINGTON SCISSORS



11" (28 cm).

ITEM #	DESCRIPTION
462120	Straight
462121	Curved

MAYO-STILLE SCISSORS



ITEM #	DESCRIPTION
KM34306	Straight, 5-1/2" (14 cm)
KM34308	Curved, 5-1/2" (14 cm)
KM34310	Straight, 6-3/4" (17 cm)
KM34312	Curved, 6-3/4" (17 cm)



SCISSORS

Mayo-Type Scissors

CHURCH SCISSORS



Lightly constructed, long scissors with a beveled surface. Mayo style blades. Blunt, dissecting tips.

ITEM #	DESCRIPTION
352250	Curved, 6-3/4" (17 cm)
352240	Straight, 7" (18 cm)

COOLEY-MAYO CURVED SCISSORS

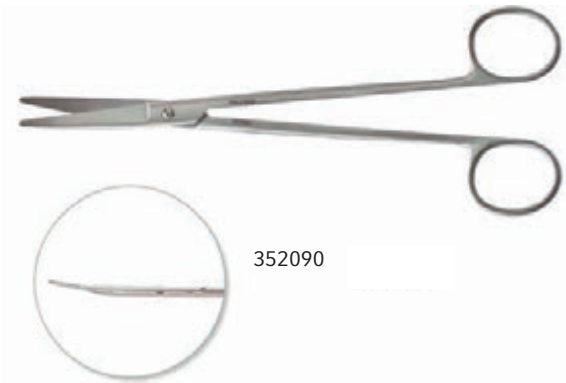

ITEM #	DESCRIPTION
352090	7-1/2" (19 cm)

DOYEN ABDOMINAL SCISSORS



KMedic® Pattern, satin finish.

ITEM #	DESCRIPTION
KM34334	Straight, 7" (18 cm)
KM34336	Curved, 7" (18 cm)

SCISSORS

Mayo-Type Scissors

DOYEN SCISSORS



141395

Pilling® Pattern, satin finish.

ITEM #	DESCRIPTION
141395	Straight, 7-1/4" (18.5 cm)

DOYEN FERGUSON SCISSORS



460720

ITEM #	DESCRIPTION
460720	Angled on flat, 59 mm blades, 7-1/8" (18 cm)

SIMS SCISSORS



KM67174

8" (20.5 cm).

ITEM #	DESCRIPTION
KM67164	Straight, Sharp/Sharp blades
KM67166	Straight, Sharp/Blunt blades
KM67168	Straight, Blunt/Blunt blades
KM67170	Curved, Sharp/Sharp blades
KM67172	Curved, Sharp/Blunt blades
KM67174	Curved, Blunt/Blunt blades



SCISSORS

Mayo-Type Scissors

SISTRUNK FINE SCISSORS



Delicate, 5-1/2" (14 cm).

ITEM #	DESCRIPTION
KM34348	Straight
KM34354	Curved

SISTRUNK HEAVY SCISSORS



ITEM #	DESCRIPTION
KM34356	Straight, 5-1/2" (14 cm)

JORGENSON SCISSORS



Heavy, rigid body with acutely curved blades that taper to a rounded narrow tip.

ITEM #	DESCRIPTION
342273	8-3/4" (22 cm)

SCISSORS

Mayo-Type Scissors

THOREK SCISSORS

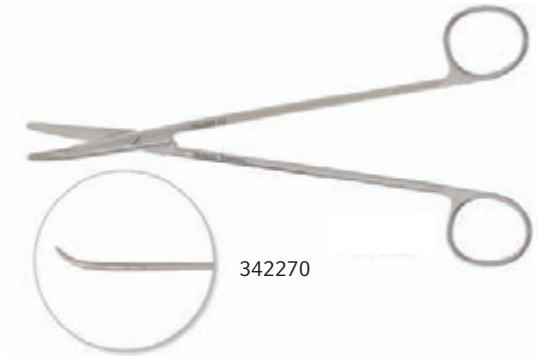

Medium weight construction, round surface, acutely curved blades.

ITEM #	DESCRIPTION
342270	7-1/4" (18.5 cm)
342272	10" (25.5 cm)

MARTIN CARTILAGE SCISSORS



ITEM #	DESCRIPTION
790320	Curved, serrated blades, 8" (20.5 cm)

DEAN SCISSORS

ITEM #	DESCRIPTION
KM34642	Angled, serrated, 7" (18 cm)

GORNEY RHYTIDECTOMY SCISSORS



ITEM #	DESCRIPTION
442560	Straight, serrated, 6-3/4" (17 cm)



SCISSORS

Metzenbaum-Type Scissors

BABY METZENBAUM SCISSORS

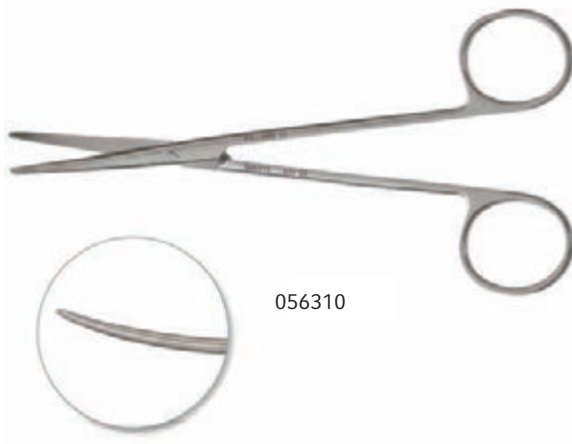

Weck® Pattern, bright finish.

ITEM #	DESCRIPTION
056310	Curved, 5-3/4" (14.5 cm)

LAHEY (BABY METZ) SCISSORS



Pilling® Pattern, satin finish.

ITEM #	DESCRIPTION
141450	Straight, 5-3/4" (14.5 cm)
141452	Curved, 5-3/4" (14.5 cm)

METZENBAUM SCISSORS, DELICATE



Pilling® Pattern, satin finish. Delicate curved.

ITEM #	DESCRIPTION
141448	5-1/2" (14 cm)
352235	7" (18 cm)
352237	8" (20.5 cm)

SCISSORS

Metzenbaum-Type Scissors

METZENBAUM SCISSORS, DELICATE

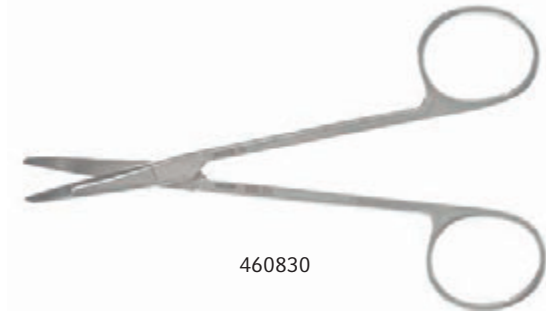

ITEM #	DESCRIPTION
460830	Curved, 29 mm delicate blades with cut-out, 5" (12.5 cm)

METZENBAUM SCISSORS

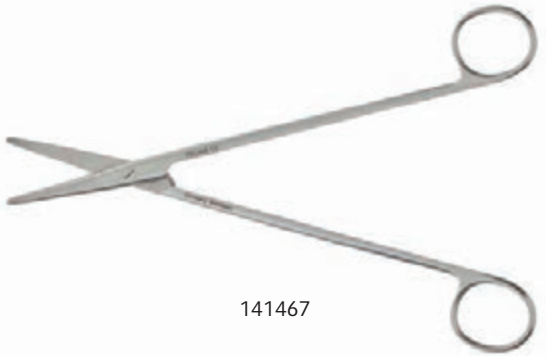

Pilling® Pattern, satin finish.

ITEM #	DESCRIPTION
141460	Straight, 7" (18 cm)
141462	Curved, 7" (18 cm)
141467	Curved, 8-1/4" (21 cm)
141469	Curved, 9" (23 cm)



SCISSORS

Metzenbaum-Type Scissors

METZENBAUM SCISSORS

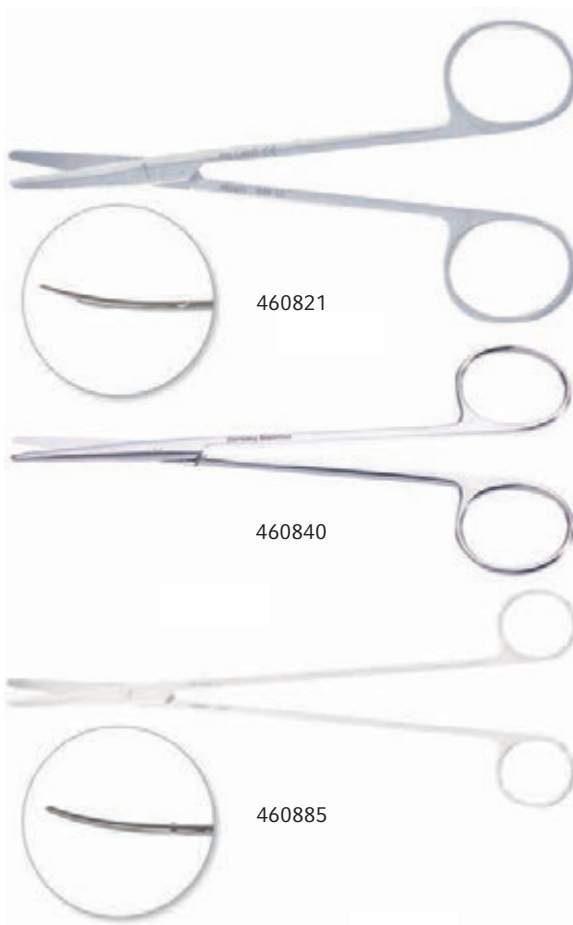

Weck® Pattern, bright finish.

ITEM #	DESCRIPTION
460820	Straight, 5" (12.5 cm)
460821	Curved, 5" (12.5 cm)
460840	Straight, 5-3/8" (13.5 cm)
460841	Curved, 5-3/8" (13.5 cm)
460880	Straight, 5-3/8" (13.5 cm)
460881	Curved, 5-3/8" (13.5 cm)
460870	Straight, 7" (18 cm)
460871	Curved, 7" (18 cm)
460884	Straight, 9" (23 cm)
460885	Curved, 9" (23 cm)
462105	Straight, 10-3/8" (26.5 cm)
462110	Curved, 10-1/4" (26 cm)
460889	Curved, 11" (28 cm)

SCISSORS

Metzenbaum-Type Scissors

METZENBAUM SCISSORS



KMedic® Pattern, satin finish, 6" and 8".

ITEM #	DESCRIPTION
KM34458	Straight, 6" (15 cm)
KM34462	Curved, 6" (15 cm)
KM34472	Straight, 8" (20.5 cm)
KM34474	Curved, 8" (20.5 cm)

METZENBAUM SCISSORS, TC



Sharp/Sharp.

ITEM #	DESCRIPTION
464707	Curved, 5-3/4" (14.5 cm), TC
464712	Straight, 7" (18 cm), TC
464718	Curved, 7" (18 cm), TC
464722	Straight, 9" (23 cm), TC
464727	Curved, 9" (23 cm), TC

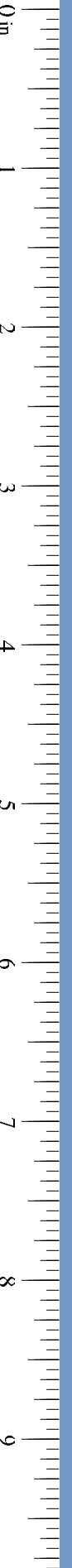

SCISSORS

Metzenbaum-Type Scissors

METZENBAUM SCISSORS, TC



Weck® Pattern, bright finish.

ITEM #	DESCRIPTION
464700	Straight, 5-3/4" (14.5 cm), TC
464705	Curved, 5-3/4" (14.5 cm), TC
464710	Straight, 7" (18 cm), TC
464715	Curved, 7" (18 cm), TC
464720	Straight, 9" (23 cm), TC
464725	Curved, 9" (23 cm), TC

METZENBAUM SCISSORS, DELICATE, TC



Delicate. Blunt/Blunt.

ITEM #	DESCRIPTION
464701	Straight, 5-3/4" (14.5 cm), TC
464706	Curved, 5-3/4" (14.5 cm), TC
464711	Straight, 7" (18 cm), TC
464716	Curved, 7" (18 cm), TC
464721	Straight, 9" (23 cm), TC
464726	Curved, 9" (23 cm), TC

SCISSORS

Metzenbaum-Type Scissors

DEBAKEY® SCISSORS

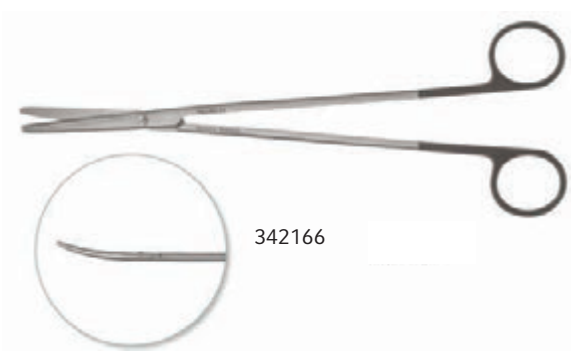

Sturdy Metzenbaum-type scissors. Black rings for quick identification.

ITEM #	DESCRIPTION
342160	Curved, 5-3/4" (14.5 cm), TC
342162	Curved, 7" (18 cm), TC
342166	Curved, 9-1/8" (23 cm), TC
342167	Curved, 10-1/4" (26 cm), TC
342168	Curved, 11-1/4" (28.5 cm), TC
342169	Curved, 12" (30.5 cm), TC

DEBAKEY®-METZENBAUM DISSECTING SCISSORS



Curved blades. These scissors are proportionately matched in weight.

ITEM #	DESCRIPTION
342200	Curved, 5-7/8" (15 cm)
342201	Curved, 7" (18 cm)
342202	Curved, 8-1/8" (20.5 cm)
342203	Curved, 9-1/8" (23 cm)
342204	Curved, 10-1/4" (26 cm)
342206	12-1/4" (31 cm)

DEMARTEL ACUTELY ANGLED SCISSORS

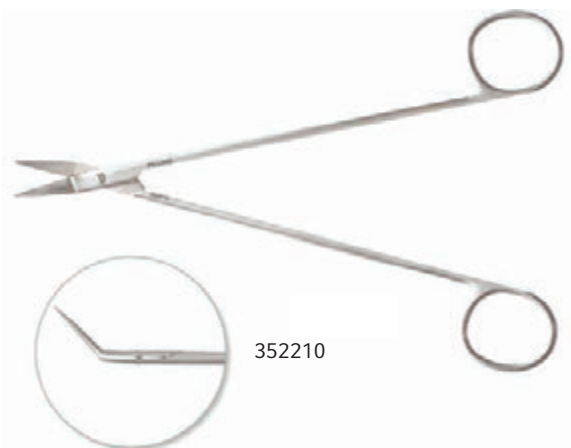

Lightweight construction.

ITEM #	DESCRIPTION
352210	Angled on flat 50 degrees, short, 16 mm blades, sharp tips, 7" (18 cm)

SCISSORS

Metzenbaum-Type Scissors

DEMARTEL SCISSORS

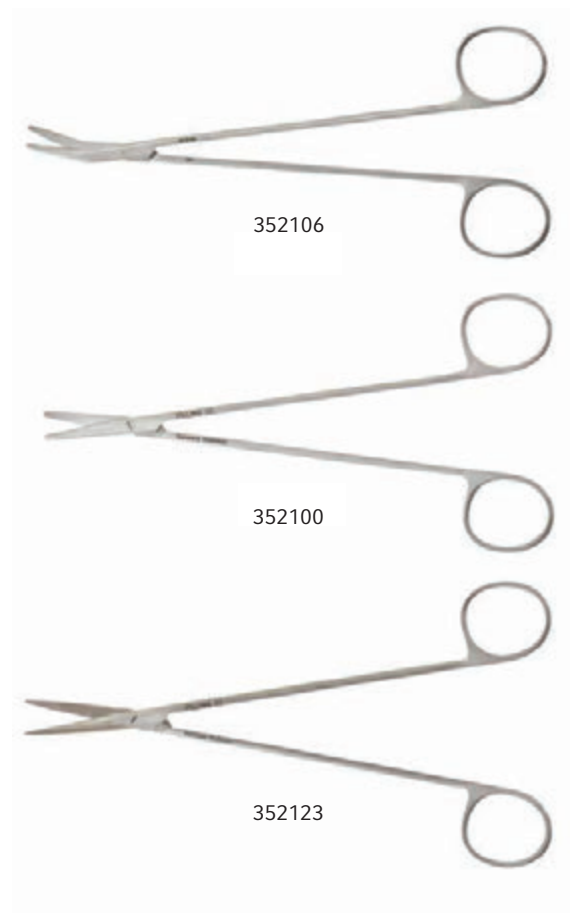

Very slim, light construction.

ITEM #	DESCRIPTION
352120	Straight, sharp blades, 6-3/4" (17 cm)
352106	Angled on flat, blunt blades, 6-3/4" (17 cm)
352109	Curved, blunt blades, 6-3/4" (17 cm)
352129	Curved, sharp blades, 6-3/4" (17 cm)
352100	Straight, blunt blades, 7" (18 cm)
352103P	Angled on flat, blunt tips, 7" (18 cm)
352123	Angled on flat, sharp blades, 7" (18 cm)
352126	Angled to side, sharp blades, 6-7/8" (17.5 cm)

FERGUSON LONG DISSECTING SCISSORS



With Metzenbaum-type, curved blades.

ITEM #	DESCRIPTION
342275	10-1/4" (26 cm)

SCISSORS

Metzenbaum-Type Scissors

NELSON LOBECTOMY SCISSORS



Pilling® Pattern, satin finish, medium weight with rounded Metzenbaum-type curved blades.

ITEM #	DESCRIPTION
342242	10-1/4" (26 cm)
342243	11-1/4" (28.5 cm)
342245	14-1/4" (36 cm)

NELSON SCISSORS



Weck® Pattern, bright finish.

ITEM #	DESCRIPTION
462148	Straight, 8" (20.5 cm)
462149	Curved, 8" (20.5 cm)
462150	Straight, 9" (23 cm)
462151	Curved, 9" (23 cm)

NELSON SCISSORS, TC



ITEM #	DESCRIPTION
464800	Curved, 11-1/8" (28.5 cm), TC
464801	Curved, 11-1/4" (28.5 cm), TC

SCISSORS

Metzenbaum-Type Scissors

JAMISON-METZENBAUM TENOTOMY SCISSORS



The standard Metzenbaum-style curved blades have specially narrowed tenotomy type distal tips.

ITEM #	DESCRIPTION
342220	6" (15 cm)
342221	7" (18 cm)
342222	8" (20.5 cm)
342223	9" (23 cm)

POTTS TENOTOMY SCISSORS



ITEM #	DESCRIPTION
640280	Curved, 6" (15 cm)

SCISSORS

Metzenbaum-Type Scissors

LINCOLN-METZENBAUM SCISSORS



Rounded, narrow dissecting tips.

ITEM #	DESCRIPTION
460883	Curved, 5-3/8" (13.5 cm)
460873	Curved, 7" (18 cm)

LINCOLN SCISSORS



Small, rounded dissecting blades.

ITEM #	DESCRIPTION
461310	Straight, 6-1/2" (16.5 cm)
461311	Curved, 6-1/2" (16.5 cm)
462201	Curved, 11" (28 cm)

STRULLY PROBED TIP SCISSORS



ITEM #	DESCRIPTION
462530	Curved, 8" (20.5 cm)



SCISSORS

Delicate and Iris-Type Scissors

DIGITATE®-HEIFETZ SCISSORS



ITEM #	DESCRIPTION
066102	Curved, 5-3/4" (14.5 cm)
066100	Straight, 5-3/4" (14.5 cm)
066104	Straight, 4-3/4" (12 cm)

MCCLURE IRIS SCISSORS



ITEM #	DESCRIPTION
144295	Angled, 4-3/4" (12 cm)

IRIS SCISSORS WITH BARRAQUER HANDLE



ITEM #	DESCRIPTION
055502	Curved, 18 mm blades, 5-3/4" (14.5 cm)

SCISSORS

Delicate and Iris-Type Scissors

BIRO DERMAL NAEVUS SCISSORS



ITEM #	DESCRIPTION
KM35515	Angled on flat, sharp outside edges, 4" (10 cm)

BLEPHAROPLASTY SCISSORS

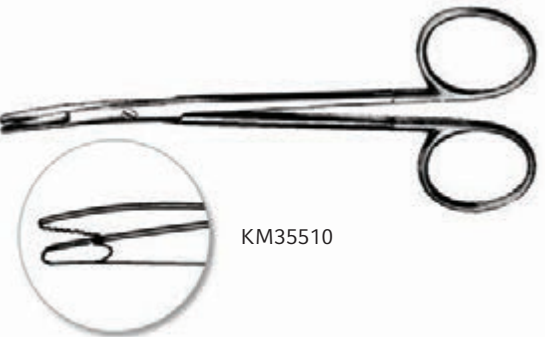

ITEM #	DESCRIPTION
KM35510	Curved flat tips, one serrated and one carbide blade, 4-1/2" (11.5 cm), TC





SCISSORS

Delicate and Iris-Type Scissors

GRADLE SCISSORS



Slightly curved, Sharp/Sharp.

ITEM #	DESCRIPTION
KM53316	3-3/4" (9.5 cm)
KM53318	4" (10 cm)

IRIS MINIATURE SCISSORS



ITEM #	DESCRIPTION
055100	Straight, 15 mm blades, 3-1/2" (9 cm)

SCISSORS

Delicate and Iris-Type Scissors

IRIS RIBBON SCISSORS



ITEM #	DESCRIPTION
KM53265	Curved, 3-3/4" (9.5 cm)
KM53267	Curved, 4" (10 cm)

IRIS SCISSORS



Pilling® Pattern, satin finish.

ITEM #	DESCRIPTION
144300	Straight, 4-1/2" (11.5 cm), stainless steel
144310	Curved, 4-1/2" (11.5 cm), stainless steel
144315	Straight, 4-1/2" (11.5 cm), TC
144317	Curved, 4-1/2" (11.5 cm), TC

IRIS SCISSORS



Weck® Pattern, bright finish.

ITEM #	DESCRIPTION
462600	Curved, 25 mm blades, 4-1/2" (11.5 cm)
462605	Straight, 25 mm blades, 4-1/2" (11.5 cm)
462640	Straight, 30 mm blades, 5" (12.5 cm)
462641	Curved, 28 mm blades, 5" (12.5 cm)





SCISSORS

Delicate and Iris-Type Scissors

IRIS SCISSORS, TC



Weck® Pattern, bright finish.

ITEM #	DESCRIPTION
462632	Straight, 4-1/2" (11.5 cm), TC
462633	Curved, 4-1/2" (11.5 cm), TC

JOSEPH SCISSORS



ITEM #	DESCRIPTION
442510	Straight, 5-3/4" (14.5 cm)
442512	Curved, 5-3/4" (14.5 cm)

KAYE SCISSORS



ITEM #	DESCRIPTION
464220	Curved, 32 mm serrated blades, 4-1/2" (11.5 cm), TC

SCISSORS

Delicate and Iris-Type Scissors

KELLY FISTULA SCISSORS



Smooth, Sharp/Sharp.

ITEM #	DESCRIPTION
KM34602	Straight, 6-1/4" (16 cm)
KM34607	Curved, 6-1/4" (16 cm)
KM34612	Angled, 6-1/4" (16 cm)

KM34607

DUFFIELD SCISSORS



Sharp/Sharp.

ITEM #	DESCRIPTION
461430	Straight, 28 mm blades, 6-1/2" (16.5 cm)
461431	Curved, 28 mm blades, 6-1/2" (16.5 cm)

461431

KNAPP IRIS SCISSORS

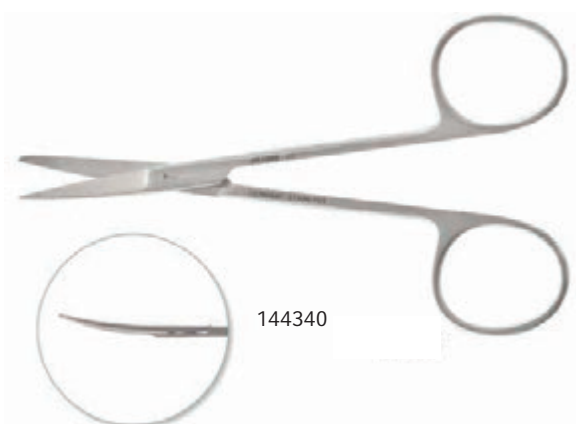

One sharp and one blunt point, 4-1/2" (11.5 cm).

ITEM #	DESCRIPTION
144338	Straight
144340	Curved

144340

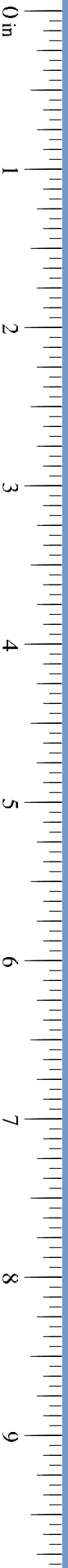



SCISSORS

Delicate and Iris-Type Scissors

LA GRANGE SCISSORS



ITEM #	DESCRIPTION
KM34621	Curved, 4-1/2" (11.5 cm)

PAR SCISSORS



ITEM #	DESCRIPTION
464810	Curved, 4-1/2" (11.5 cm), TC



SCISSORS

Delicate and Iris-Type Scissors

PLASTIC SCISSORS



ITEM #	DESCRIPTION
442502	Curved, 4-3/4" (12 cm)

PLASTIC SCISSORS



Pointed, sharp, 34 mm blades, 4-3/4" (12 cm).

ITEM #	DESCRIPTION
056200	Straight
056201	Curved

SCISSORS

Delicate and Iris-Type Scissors

RAGNELL SCISSORS, DELICATE



ITEM #	DESCRIPTION
442576	Half-curved, 4-3/4" (12 cm)

RAGNELL SCISSORS



Curved, flat blunt tips.

ITEM #	DESCRIPTION
KM34560	5" (12.5 cm)
KM34562	7" (18 cm)

SHEA VEIN GRAFT SCISSORS



ITEM #	DESCRIPTION
442525	Flat tips, 4-3/4" (12 cm)

SCISSORS

Delicate and Iris-Type Scissors

STEVENS TENOTOMY



KMedic® Pattern, satin finish, Sharp/Sharp points.

ITEM #	DESCRIPTION
KM53174	Straight, 4-3/8" (11 cm)
KM53176	Curved, 4-3/8" (11 cm)

STEVENS TENOTOMY



Pilling® Pattern, satin finish, slender style.

ITEM #	DESCRIPTION
144350	Straight, 4-1/2" (11.5 cm)
144352	Slightly curved blades, 4-1/2" (11.5 cm)

STEVENS TENOTOMY, DELICATE



Pilling® Pattern, satin finish.

ITEM #	DESCRIPTION
442515	Curved, 5" (12.5 cm)

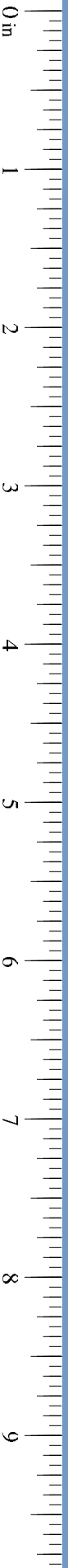

SCISSORS

Delicate and Iris-Type Scissors

STEVENS TENOTOMY



Weck® Pattern, bright finish.

ITEM #	DESCRIPTION
462680	Straight, 4-1/2" (11.5 cm)
462681	Curved, 4-1/2" (11.5 cm)
056110	Curved, 5-1/8" (13 cm)

STRABISMUS SCISSORS



Pilling® Pattern, satin finish. Rounded blades and tips.

ITEM #	DESCRIPTION
144319	Straight, 4-1/2" (11.5 cm), TC
144321	Curved, 4-1/2" (11.5 cm), TC
144330	Straight, round shank, 4-3/4" (12 cm), stainless steel
144332	Curved, round shank, 4-3/4" (12 cm), stainless steel

STRABISMUS SCISSORS



Weck® Pattern, bright finish. Rounded 30 mm dissecting blades.

ITEM #	DESCRIPTION
462690	Straight, 4-1/2" (11.5 cm)
462691	Curved, 4-1/2" (11.5 cm)

SCISSORS

Delicate and Iris-Type Scissors

WUTZLER SCISSORS



28 mm dissecting blades.

ITEM #	DESCRIPTION
462540	Straight, Blunt/Blunt blades, 5" (12.5 cm)
462541	Curved, Blunt/Blunt blades, 5" (12.5 cm)
462550	Straight, Sharp/Sharp blades, 4-3/4" (12 cm)

GOLDMAN-FOX SCISSORS

ITEM #	DESCRIPTION
KM34648	Curved, serrated, 5" (12.5 cm)



SCISSORS

Super-Cut and Ultimate-Cut Scissors

Our KMedic® Super-Cut Scissors and Pilling® Ultimate-Cut Scissors are manufactured with the finest surgical stainless steel, the latest heat treating methods and master craftsmanship.

Both style scissors are designed with one razor sharp blade edge. The Super-Cut scissors' opposite blade has a standard smooth edge, while the Ultimate-Cut scissors' opposite blade incorporates a micro-serrated edge.

SUPER-CUT LISTER BANDAGE SCISSORS



KM35210

ITEM #	DESCRIPTION
KM35210	5-3/4" (14.5 cm)
KM35212	7-1/4" (18.5 cm)

SUPER-CUT HI-LEVEL BANDAGE SCISSORS

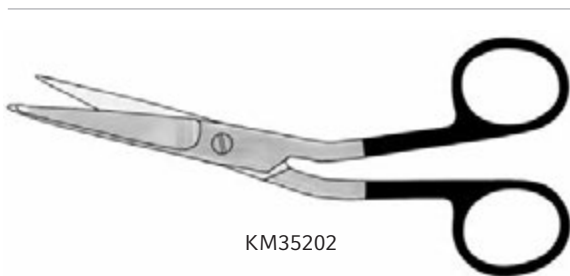

KM35202

The delicate offset shanks and the sharp Super-Cut edge provide better leverage. The fine knob slides easily under finger bandages.

ITEM #	DESCRIPTION
KM35202	Straight, angled on side, 5-1/2" (14 cm)

SUPER-CUT LISTER BANDAGE SCISSORS WITH LARGE FINGER RING

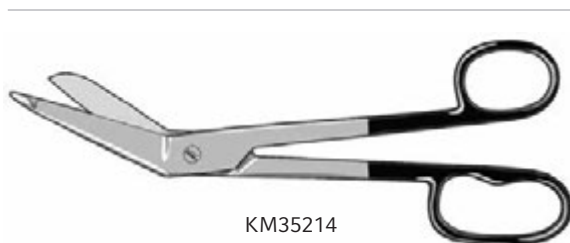

KM35214

Razor sharp scissors ideal for cutting heavy material including: moleskin, drapes and stockinette. Not recommended for fiberglass or plaster splints. Oversized finger ring helps relieve pressure on the third metacarpal.

ITEM #	DESCRIPTION
KM35214	Straight, 8" (20.5 cm)

SCISSORS

Super-Cut and Ultimate-Cut Scissors

SUPER-CUT OPERATING SCISSORS



Sharp/Blunt.

ITEM #	DESCRIPTION
KM35220	Straight, 5-1/2" (14 cm)
KM35250	Curved, 5-3/4" (14.5 cm)

SUPER-CUT MAYO SCISSORS



Beveled blades, blunt points.

ITEM #	DESCRIPTION
KM35280	Straight, 5-3/4" (14.5 cm)
KM35286	Curved, 5-3/4" (14.5 cm)
KM35292	Straight, 6-3/4" (17 cm)
KM35298	Curved, 6-3/4" (17 cm)
KM35316	Straight, 9-1/4" (23.5 cm)
KM35322	Curved, 9" (23 cm)
KM35340	Curved, 11" (28 cm)

ULTIMATE-CUT COOLEY SCISSORS



ITEM #	DESCRIPTION
463950	Curved, with one serrated blade, 7-3/4" (19.5 cm)



SCISSORS

Super-Cut and Ultimate-Cut Scissors

SUPER-CUT (BABY) METZENBAUM SCISSORS



Blunt points.

ITEM #	DESCRIPTION
KM35364	Straight, 4-1/2" (11.5 cm)
KM35370	Curved, 4-1/2" (11.5 cm)

SUPER-CUT METZENBAUM SCISSORS



Blunt points.

ITEM #	DESCRIPTION
KM35380	Straight, 6" (15 cm)
KM35382	Curved, 5-5/8" (14.5 cm)
KM35392	Straight, 7" (18 cm)
KM35394	Curved, 7" (18 cm)
KM35396	Curved, delicate, 7" (18 cm)
KM35406	Curved, 8" (20.5 cm)
KM35418	Curved, 9" (23 cm)
KM35430	Curved, 11-1/4" (28.5 cm)

SUPER-CUT JAMISON SCISSORS



ITEM #	DESCRIPTION
KM35496	Curved blunt points, very delicate, 6-1/4" (16 cm)

SCISSORS

Super-Cut and Ultimate-Cut Scissors

SUPER-CUT STEVENS SCISSORS



Blunt points. Delicate short narrow tips for dissecting fine tissue.

ITEM #	DESCRIPTION
KM35484	Straight, 4-1/2" (11.5 cm)
KM35490	Curved, 4-1/2" (11.5 cm)
KM35494	Curved, 5-1/4" (13.5 cm)

SUPER-CUT IRIS SCISSORS



Sharp points.

ITEM #	DESCRIPTION
KM35450	Straight, 3-1/2" (9 cm)
KM35452	Curved, 3-1/2" (9 cm)
KM35454	Straight, 4-1/2" (11.5 cm)
KM35460	Curved, 4-1/2" (11.5 cm)

SCISSORS

Super-Cut and Ultimate-Cut Scissors

ULTIMATE CUT MAYO SCISSORS



ITEM #	DESCRIPTION
463900	Straight, 6-3/4" (17 cm)
463901	Curved, 6-3/4" (17 cm)
463903	Curved, 9-1/8" (23 cm)

ULTIMATE CUT METZENBAUM SCISSORS



ITEM #	DESCRIPTION
463910	Straight, 5-3/4" (14.5 cm)
463911	Curved, 5-3/4" (14.5 cm)
463912	Straight, 6-7/8" (17.5 cm)
463913	Curved, 7" (18 cm)
463915	Curved, 9" (23 cm)

ULTIMATE CUT POTTS SCISSORS

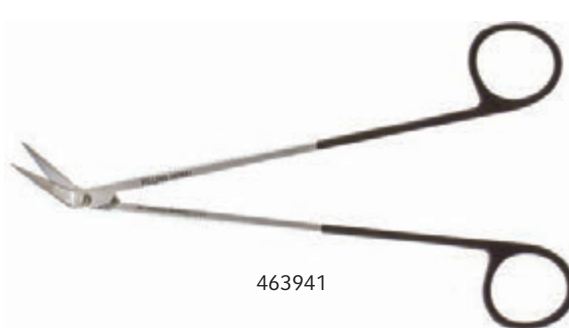

ITEM #	DESCRIPTION
463941	Angled 45 degrees, with one serrated blade, 7-1/4" (18.5 cm)

SCISSORS

Super-Cut and Ultimate-Cut Scissors

ULTIMATE CUT STEVENS TENOTOMY SCISSORS



ITEM #	DESCRIPTION
463920	Straight, 4-1/2" (11.5 cm)
463921	Curved, 4-1/2" (11.5 cm)

463920

IRIS SCISSORS



Sharp/Sharp.

ITEM #	DESCRIPTION
463930	Straight with one serrated blade, 4-1/2" (11.5 cm)
463932	Curved with one serrated blade, 4-1/2" (11.5 cm)

463932

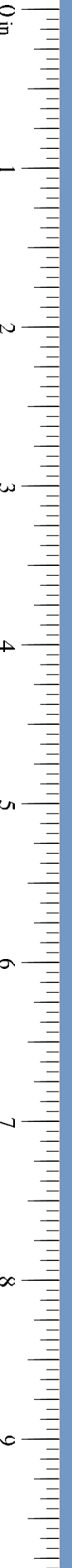



NEEDLE HOLDERS

General Needle Holders

BAUMGARTNER NEEDLE HOLDER



ITEM #	DESCRIPTION
152710	11.7 x 2.2 mm jaw, 5-1/4" (13.5 cm), TC

BAUMGARTNER BULLDOG® NEEDLE HOLDER



ITEM #	DESCRIPTION
510181	1.6 mm jaw, 5" (12.5 cm), TC

NEEDLE HOLDERS

General Needle Holders

BROWN NEEDLE HOLDER



ITEM #	DESCRIPTION
055200	Regular, convex jaw with fine oblique serrations, 15 x 2.7 mm, 5" (12.5 cm), stainless steel jaw

CONVERSE NEEDLE HOLDER



ITEM #	DESCRIPTION
443100	Large rings, 14 x 2.3 mm jaw, 5" (12.5 cm), stainless steel jaw

DERF NEEDLE HOLDERS



Weck® Pattern, bright finish.

ITEM #	DESCRIPTION
055135	10.2 x 2.4 mm jaw, 4-3/4" (12 cm), TC





NEEDLE HOLDERS

General Needle Holders

DERF NEEDLE HOLDERS



Pilling® Pattern, satin finish.

ITEM #	DESCRIPTION
152798	7.5 x 1.7 mm jaw, 4-1/2" (11.5 cm), TC

DERF NEEDLE HOLDER STANDARD - STAINLESS STEEL JAW



ITEM #	DESCRIPTION
443120	9.5 x 2 mm jaw, 5" (12.5 cm)

NEEDLE HOLDERS

General Needle Holders

GILLIES NEEDLE HOLDER SCISSORS



Large offset thumb ring.

ITEM #	DESCRIPTION
152496	2.2 mm jaw, 6-1/4" (16 cm), TC

HALSEY NEEDLE HOLDERS



KMedic® Pattern, satin finish. Stainless steel jaw.

ITEM #	DESCRIPTION
KM41064	Smooth, 2.5 mm jaw, 5" (12.5 cm)
KM41066	Serrated, 2.2 mm jaw, 5-1/4" (13.5 cm)

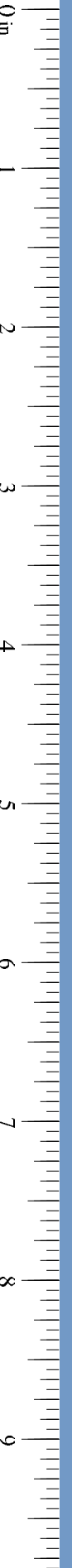



NEEDLE HOLDERS

General Needle Holders

HALSEY NEEDLE HOLDERS



Pilling® Pattern, satin finish.

ITEM #	DESCRIPTION
152802	Smooth, 11.5 x 1.8 mm jaw, 5-1/4" (13.5 cm), TC
152800	Serrated, 11 x 2.2 mm jaw, 5-1/4" (13.5 cm), TC

JOHNSON BULLDOG® NEEDLE HOLDER



ITEM #	DESCRIPTION
510311	9.7 x 2.5 mm, Bulldog® Jaw, 4-3/4" (12 cm), TC

JOHNSON NEEDLE HOLDER



ITEM #	DESCRIPTION
510312	12 x 2 mm jaw, 4-3/4" (12 cm), TC

NEEDLE HOLDERS

General Needle Holders

NEIVERT NEEDLE HOLDER



Off-set ring handle.

ITEM #	DESCRIPTION
152805	16 x 2 mm jaw, 5-1/4" (13.5 cm), TC

PAR NEEDLE HOLDERS



ITEM #	DESCRIPTION
510335	13 x 2 mm jaw, 5" (12.5 cm), TC
510395	11 x 1.8 mm jaw, 5-1/2" (14 cm), TC



NEEDLE HOLDERS

General Needle Holders

WEBSTER NEEDLE HOLDERS



Pilling® Pattern, satin finish.

ITEM #	DESCRIPTION
152808	10.2 x 1.8 mm smooth jaw, 4-1/2" (11.5 cm), TC

WEBSTER NEEDLE HOLDERS



Weck® Pattern, bright finish.

ITEM #	DESCRIPTION
510325	Delicate, smooth, 13 x 2.2 mm jaw, 4-3/4" (12 cm), TC

NEEDLE HOLDERS

General Needle Holders

WEBSTER BULLDOG® NEEDLE HOLDER



Weck® Pattern, bright finish.

ITEM #	DESCRIPTION
510321	Delicate, smooth, 13.5 x 2 mm Bulldog® jaw, 4-3/4" (12 cm), TC

WEBSTER NEEDLE HOLDERS

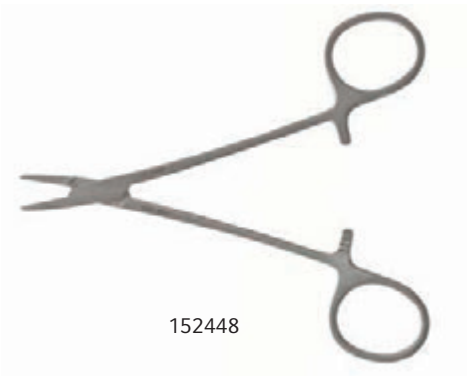

ITEM #	DESCRIPTION
152448	16 x 2.2 mm smooth stainless steel jaw, 5" (12.5 cm)





NEEDLE HOLDERS

General Needle Holders

WEBSTER NEEDLE HOLDERS



KM41068

ITEM #	DESCRIPTION
KM41068	Smooth, stainless steel jaw, 5" (12.5 cm)

OLSEN HEGAR NEEDLE HOLDER AND SCISSORS



510440



510441

Weck® Pattern, bright finish.

ITEM #	DESCRIPTION
510440	11 x 3.2 mm jaw, 5-3/4" (14.5 cm), TC
510441	15 x 3.1 mm jaw, 6" (15 cm), stainless steel jaw
510445	11.5 x 3.2 mm jaw, 7" (18 cm), TC

NEEDLE HOLDERS

General Needle Holders

OLSEN-HEGAR NEEDLE HOLDERS



Combination needle holder and suture scissors.
KMedic® Pattern, satin finish.

ITEM #	DESCRIPTION
KM41424	Delicate, 4-3/4" (12 cm)
KM41428	5" (12.5 cm)
KM41440	Delicate, 4-1/2" (11.5 cm), TC
KM41452	6-1/2" (16.5 cm), TC

RYDER FRENCH EYE NEEDLE HOLDERS



Pilling® Pattern, satin finish.

ITEM #	DESCRIPTION
152760	20 x 2 mm jaw, 6" (15 cm), TC
152762	20.5 x 2 mm jaw, 7-1/4" (18.5 cm), TC
152764	20 x 2 mm jaw, 8" (20.5 cm), TC

NEEDLE HOLDERS

General Needle Holders

RYDER BULLDOG® NEEDLE HOLDERS

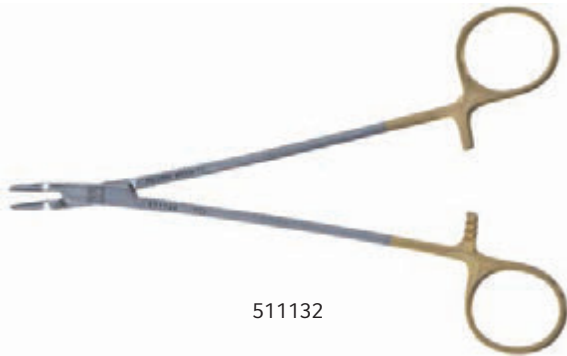

Weck® Pattern, bright finish. French eye with fine serrations and delicate, tapered, Bulldog® Jaw.

ITEM #	DESCRIPTION
511115	9.5 x 2 mm jaw, 5" (12.5 cm), TC
511130	12 x 2 mm jaw, 6" (15 cm), TC
511132	13 x 1.7 mm jaw, 7" (18 cm), TC
511134	13 x 2 mm jaw, 7-3/4" (19.5 cm), TC
511138	12.5 x 1.8 mm jaw, 10" (25.5 cm), TC

RYDER NEEDLE HOLDERS

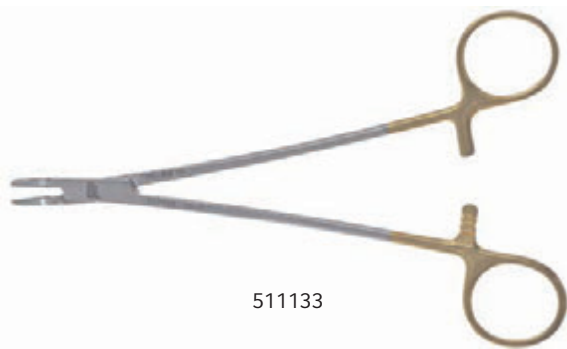

Weck® Pattern, bright finish. French eye with fine serrations and delicate, tapered jaw.

ITEM #	DESCRIPTION
511131	12.5 x 2 mm jaw, 6-1/4" (16 cm), TC
511133	13 x 2.2 mm jaw, 7" (18 cm), TC
511135	12.5 x 1.7 mm jaw, 8" (20.5 cm), TC
511139	12 x 2 mm jaw, 10" (25.5 cm), TC

RYDER EXTRA FINE TECHNIQUE® NEEDLE HOLDERS



Pilling® Pattern, satin finish. Sculptured 1 mm wide jaws designed for the finest vascular, plastic and nerve suture needles. Lightweight throughout (average weight 1 oz).

ITEM #	DESCRIPTION
354990	11.5 x 1.3 mm jaw, 5-1/4" (13.5 cm), TC
354992	12.5 x 1.2 mm jaw, 6" (15 cm), TC
354994	14.3 x 1.2 mm jaw, 7" (18 cm), TC
354996	14.5 x 1.2 mm jaw, 8" (20.5 cm), TC
354998	15 x 1.3 mm jaw, 9" (23 cm), TC

NEEDLE HOLDERS

General Needle Holders

CRILE WOOD NEEDLE HOLDERS



Pilling® Pattern, satin finish.

ITEM #	DESCRIPTION
152771	Left-handed, 7" (18 cm), TC
152780	6" (15 cm), TC
152781	Smooth, 6" (15 cm), TC
152782	7" (18 cm), TC
152784	8" (20.5 cm), TC
152786	9" (23 cm), TC
152790	Curved, 7" (18 cm), TC
152792	Curved, 9-1/4" (23.5 cm), TC

CRILE WOOD NEEDLE HOLDERS



Weck® Pattern, bright finish. Delicate, tapered-tip.

ITEM #	DESCRIPTION
510400	6" (15 cm), TC
510405	7" (18 cm), TC
510410	8" (20.5 cm), TC
510415	9" (23 cm), TC
510420	10-1/4" (26 cm), TC
510430	12-1/4" (31 cm), TC



NEEDLE HOLDERS

General Needle Holders

CRILE MURRAY BULLDOG® NEEDLE HOLDERS



Weck® Pattern, bright finish. Long, slender Bulldog® Jaw.

ITEM #	DESCRIPTION
510241	15.4 x 1.8 mm jaw, 6-1/4" (16 cm), TC
510251	15.5 x 2.4 mm jaw, 7" (18 cm), TC

CRILE WOOD BULLDOG® NEEDLE HOLDERS



Weck® Pattern, bright finish. Bulldog® Jaw.

ITEM #	DESCRIPTION
510201	Light, 6-1/4" (16 cm), TC
510211	Heavy, 6-1/4" (16 cm), TC

NEEDLE HOLDERS

General Needle Holders

HEGAR BAUMGARTNER NEEDLE HOLDERS



Serrated stainless steel jaw.

ITEM #	DESCRIPTION
KM41162	Serrated, 5" (12.5 cm)
KM41164	Serrated, 5-3/4" (14.5 cm)

MAYO HEGAR NEEDLE HOLDERS



Pilling® Pattern, satin finish.

ITEM #	DESCRIPTION
152720	14.5 x 3 mm jaw, 6-1/2" (16.5 cm), TC
152402	23 x 2.8 mm jaw, 7-1/4" (18.5 cm), TC
152722	16.5 x 3.3 mm jaw, 7-1/2" (19 cm), TC
152724	17 x 2.8 mm jaw, 8" (20.5 cm), TC
152406	17 x 2.8 mm jaw, 9-1/4" (23.5 cm), TC
152772	Left-handed, 13 x 2.4 mm jaw, 6-1/4" (16 cm), TC

NEEDLE HOLDERS

General Needle Holders

MAYO HEGAR NEEDLE HOLDERS



Weck® Pattern, bright finish, narrow.

ITEM #	DESCRIPTION
510100	14.6 x 2.6 mm jaw, 6" (15 cm), TC
510110	16.2 x 2.8 mm jaw, 7" (18 cm), TC
510120	15.7 x 3 mm jaw, 8" (20.5 cm), TC
510130	16.4 x 3.2 mm jaw, 9" (23 cm), TC
510140	16.3 x 3.5 mm jaw, 11-3/4" (30 cm), TC

MAYO HEGAR NEEDLE HOLDERS

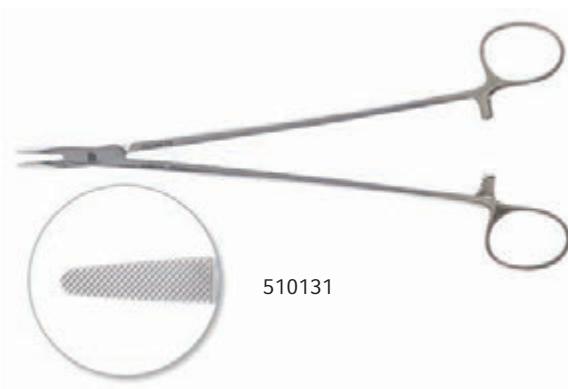

Weck® Pattern, bright finish, Bulldog® Jaw, narrow.

ITEM #	DESCRIPTION
510101	15.5 x 3 mm jaw, 6" (15 cm), TC
510111	16 x 2.8 mm jaw, 7" (18 cm), TC
510121	19 x 2.7 mm jaw, 8" (20.5 cm), TC
510131	20 x 3 mm jaw, 9" (23 cm), TC

NEEDLE HOLDERS

General Needle Holders

MAYO HEGAR NEEDLE HOLDERS



Serrated, stainless steel jaw.

ITEM #	DESCRIPTION
KM41270	5-1/2" (14 cm)
KM41272	6" (15 cm)
KM41278	7" (18 cm)
KM41284	8" (20.5 cm)
KM41286	10-1/2" (26.5 cm)
KM41300	5" (12.5 cm), TC

MAYO HEGAR BROAD BULLDOG® NEEDLE HOLDERS

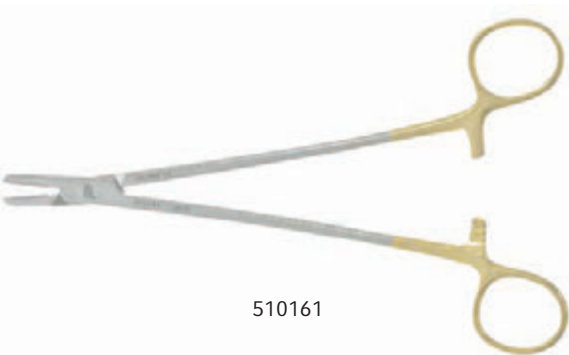

Weck® Pattern, bright finish, Bulldog® Jaw, broad.

ITEM #	DESCRIPTION
510151	12 x 4 mm jaw, 7" (18 cm), TC
510161	17 x 3.5 mm jaw, 8" (20.5 cm), TC

MASSON BULLDOG® NEEDLE HOLDERS

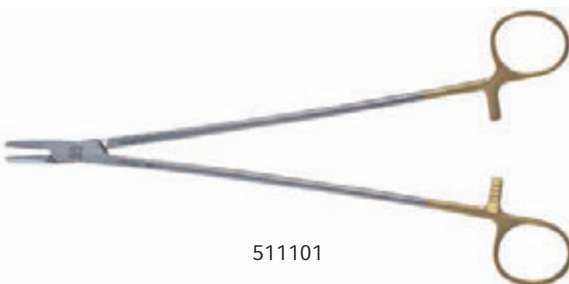

ITEM #	DESCRIPTION
511101	Heavy, 18.5 x 3 mm jaw, 10-1/4" (26 cm), TC
511102	Light, 18.5 x 3.2 mm jaw, 10-1/4" (26 cm), TC

NEEDLE HOLDERS

General Needle Holders

MASSON NEEDLE HOLDERS

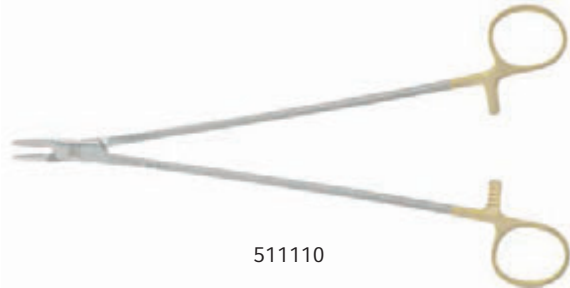

ITEM #	DESCRIPTION
511110	15.5 x 2.4 mm jaw, 7" (18 cm), TC
511112	16 x 3.2 mm jaw, 11-3/4" (30 cm), TC

HEANEY BULLDOG® NEEDLE HOLDER

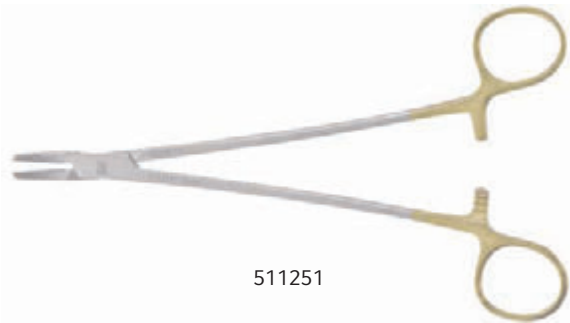

ITEM #	DESCRIPTION
511251	19.3 x 3.2 mm curved Bulldog® Jaw, 8" (20.5 cm), TC

HEANEY NEEDLE HOLDERS



ITEM #	DESCRIPTION
511250	20.5 x 2.6 mm curved jaw with cross serrations, 8" (20.5 cm), TC

NEEDLE HOLDERS

General Needle Holders

HEANEY NEEDLE HOLDERS



ITEM #	DESCRIPTION
511252	3.2 mm straight jaw, 8" (20.5 cm), serrated stainless steel jaw

HEANEY NEEDLE HOLDERS



ITEM #	DESCRIPTION
152837	25.6 x 2.5 mm curved jaw, 10-1/2" (26.5 cm), TC

MCALLISTER BULLDOG® NEEDLE HOLDER

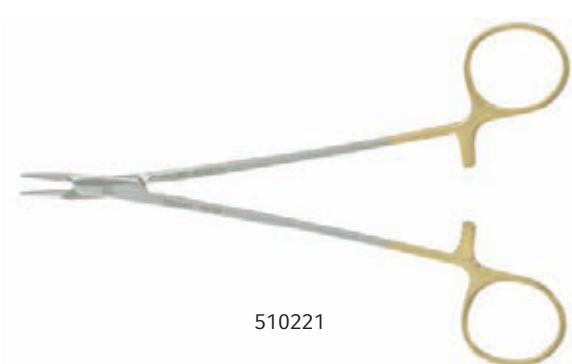

ITEM #	DESCRIPTION
510221	Long, delicate, 14.5 x 1.8 mm, Bulldog® Jaw, 7" (18 cm), TC

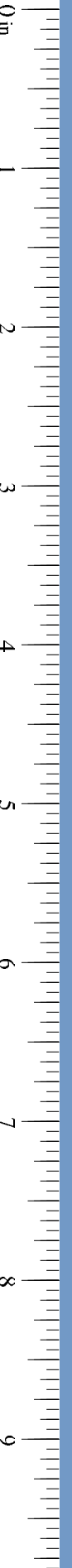



NEEDLE HOLDERS

General Needle Holders

SAROT NEEDLE HOLDERS



Weck® Pattern, bright finish. Parallel shanks with offset finger rings.

ITEM #	DESCRIPTION
510467	16.5 x 1.8 mm jaw, 7" (18 cm), TC
510469	17 x 1.8 mm jaw, 9" (23 cm), TC

SAROT NEEDLE HOLDER



ITEM #	DESCRIPTION
152796	19.5 x 1.8 mm jaw, 10-1/4" (26 cm), TC

NEEDLE HOLDERS

General Needle Holders

STRATTE NEEDLE HOLDERS



ITEM #	DESCRIPTION
152855	22 x 2.7 mm jaw, 8" (20.5 cm), TC
343027	Reverse curved, 9" (23 cm), TC

CVT-Type Needle Holders

BAILEY CARDIAC TECHNIQUE® NEEDLE HOLDER



Very light construction throughout with fine tapered tips. Jaws are lightly scored for use with smallest size needles and sutures. Tungsten Carbide.

ITEM #	DESCRIPTION
354931	17 x 2 mm jaw, 7" (18 cm), TC



NEEDLE HOLDERS

CVT-Type Needle Holders

DEBAKEY® TECHNIQUE® NEEDLE HOLDERS



Carefully designed with light, short Tungsten Carbide jaws. Constructed in weight proportional to total length. May be purchased individually or as matched set of four.

ITEM #	DESCRIPTION
354900	No. 1. Length, 18.2 x 2 mm jaw, 7" (18 cm), TC
354902	No. 2. Length, 21.5 x 1.8 mm jaw, 9-1/4" (23.5 cm), TC
354904	No. 3. Length, 21.5 x 2.3 mm jaw, 10-1/2" (26.5 cm), TC
354906	No. 4. Length, 19 x 2.6 mm jaw, 11-3/4" (30 cm), TC
354908	Matched set of four, TC

FINOCHIETTO NEEDLE HOLDER



ITEM #	DESCRIPTION
152842	25.5 x 2.5 mm jaw, 10-1/2" (26.5 cm), TC

NEEDLE HOLDERS

CVT-Type Needle Holders

GERBODE TECHNIQUE® NEEDLE HOLDER



Medium-light construction. A strong full-sized needle holder with jaws tapered to 2 mm width for holding fine needles.

ITEM #	DESCRIPTION
343000	16.5 x 2 mm jaw, 10-1/2" (26.5 cm), TC

HOWELL CORONARY TECHNIQUE® NEEDLE HOLDER



ITEM #	DESCRIPTION
354920	14 x 1.6 mm jaw, 7-1/4" (18.5 cm), TC

HOWELL VALVE TECHNIQUE® NEEDLE HOLDER

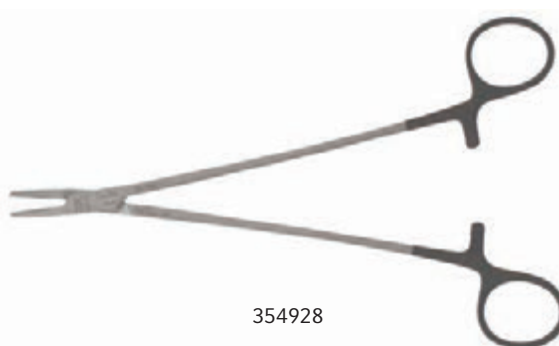

ITEM #	DESCRIPTION
354928	19 x 2 mm jaw, 8" (20.5 cm), TC

NEEDLE HOLDERS

CVT-Type Needle Holders

JAMISON TECHNIQUE® NEEDLE HOLDER



Long, slender needle holder. Jaws are lightly serrated.

ITEM #	DESCRIPTION
354941	19.8 x 1.8 mm jaw, 9" (23 cm), TC

JULIAN NEEDLE HOLDER

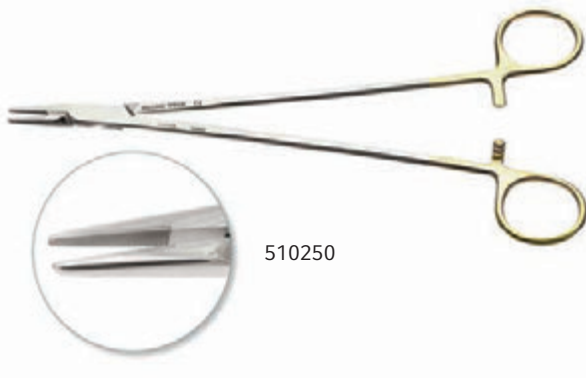

ITEM #	DESCRIPTION
510250	Straight, 21 x 2 mm jaw, 8" (20.5 cm), TC

PILLING® EXTRA LIGHT TECHNIQUE® NEEDLE HOLDERS



Thinner shanks and box locks than Pilling® Thin Needle Holders for reduced weight and more "feel."

ITEM #	DESCRIPTION
354981	17 x 1.8 mm jaw, 6" (15 cm), TC
354982	17.5 x 1.6 mm jaw, 7" (18 cm), TC

NEEDLE HOLDERS

CVT-Type Needle Holders

PILLING® INTRACARDIAC TECHNIQUE® NEEDLE HOLDERS



ITEM #	DESCRIPTION
354985	17 x 1.8 mm jaw, 7" (18 cm), TC
354986	11.5 x 1.6 mm jaw, 8" (20.5 cm), TC
354987	20.5 x 2 mm jaw, 9-1/4" (23.5 cm), TC
354988	20.5 x 2 mm jaw, 10-1/4" (26 cm), TC

PILLING® THIN VASCULAR AND CORONARY TECHNIQUE® NEEDLE HOLDERS



Delicately proportioned, slender needle holders.

ITEM #	DESCRIPTION
354961	16 x 1.7 mm jaw, 7" (18 cm), TC
354960	16 x 1.8 mm jaw, 6" (15 cm), TC
354962	20 x 1.8 mm jaw, 8-1/4" (21 cm), TC
354958	20.5 x 1.8 mm jaw, 9" (23 cm), TC
354959	20.5 x 2.2 mm jaw, 10-1/4" (26 cm), TC



NEEDLE HOLDERS

CVT-Type Needle Holders

W.M. LEMMON TECHNIQUE® NEEDLE HOLDERS

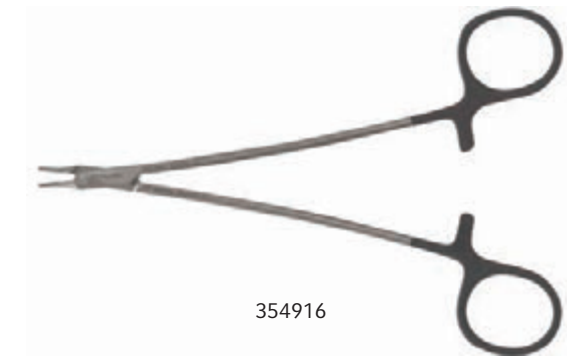

ITEM #	DESCRIPTION
354915	Delicate, 15.5 x 2.3 mm jaw, 5-3/4" (14.5 cm), TC
354916	14.5 x 1.5 mm jaw, 6-3/4" (17 cm), TC
354917	15.5 x 2.3 mm jaw, 7-1/2" (19 cm), TC

WANGENSTEEN NEEDLE HOLDER



ITEM #	DESCRIPTION
152850	29.4 x 2.3 mm jaw, 10-3/4" (27.5 cm), TC

NEEDLE HOLDERS

Castro-Type Micro Needle Holders

MICRO VASCULAR ROUND HANDLE NEEDLE HOLDERS



ITEM #	DESCRIPTION
357654	Straight, without lock, 1.1 mm smooth jaw, 7-3/8" (18.5 cm)
357655	Curved, without lock, smooth, 7-3/8" (18.5 cm)
357656	Straight, with lock, 1.2 mm smooth jaw, 7-1/2" (19 cm)
357657	Curved, with lock, 0.6 mm smooth jaw, 7-3/8" (18.5 cm)
357667	Straight, with lock, 7-3/8" (18.5 cm), TC
357672	Straight, with lock, 0.6 mm smooth jaw, 8-1/8" (20.5 cm)
357674	Straight, with lock, 0.6 mm smooth jaw, 9" (23 cm)
357675	Curved, with lock, 0.6 mm smooth jaw, 9" (23 cm)
357676	Straight, with lock, 8" (20.5 cm), TC
357677	Curved, with lock, 1 mm jaw, 8" (20.5 cm), TC

BARRAQUER MICRO NEEDLE HOLDERS



With lock, round handle.

ITEM #	DESCRIPTION
KM44167	Straight, smooth, 5-1/2" (14 cm)
KM44163	Curved, smooth, 5-1/2" (14 cm)
KM44169	Straight, smooth, 7" (18 cm)
KM44165	Curved, smooth, 7" (18 cm)
KM44168	Straight, smooth, 5-1/2" (14 cm), TC
KM44164	Curved, smooth, 5-1/2" (14 cm), TC
KM44157	Straight, serrated, 5-1/2" (14 cm), TC
KM44155	Curved, serrated, 5-1/2" (14 cm), TC
KM44170	Straight, smooth, 7" (18 cm), TC
KM44166	Curved, smooth, 7" (18 cm), TC
KM44158	Straight, serrated, 7" (18 cm), TC
KM44156	Curved, serrated, 7" (18 cm), TC

NEEDLE HOLDERS

Castro-Type Micro Needle Holders

CASTROVIEJO NEEDLE HOLDERS

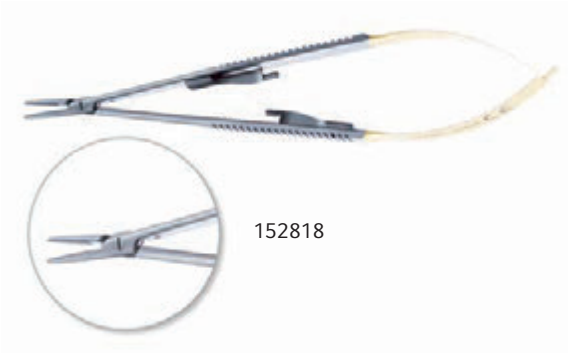

152818

ITEM #	DESCRIPTION
152818	Straight, 11 x 1.4 mm jaw, 6" (15 cm), TC
152819	Curved, 12 x 1.4 mm jaw, 5-3/4" (14.5 cm), TC

MICRO SURGERY NEEDLE HOLDERS



152825

Flat handle, smooth jaws.

ITEM #	DESCRIPTION
152825	Straight, 12.5 x 1.4 mm jaw, 6" (15 cm), TC
152827	Curved, 13 x 1.4 mm jaw, 6" (15 cm), TC

CASTROVIEJO MICRO NEEDLE HOLDERS



KM44204

With lock.

ITEM #	DESCRIPTION
KM44201	Straight, serrated, 5-1/2" (14 cm)
KM44200	Curved, serrated, 5-1/2" (14 cm)
KM44204	Straight, smooth, 7" (18 cm)
KM44202	Curved, smooth, 7" (18 cm)
KM44205	Straight, serrated, 7" (18 cm)
KM44203	Curved, serrated, 7" (18 cm)
KM44208	Straight, serrated, 5-1/2" (14 cm), TC
KM44215	Straight, smooth, 7" (18 cm), TC
KM44214	Curved, smooth, 7" (18 cm), TC
KM44207	Curved, serrated, 7" (18 cm), TC

NEEDLE HOLDERS

Castro-Type Micro Needle Holders

CASTROVIEJO MICRO NEEDLE HOLDERS



KM44219

Without lock.

ITEM #	DESCRIPTION
KM44218	Curved, serrated, 5-1/2" (14 cm)
KM44219	Straight, serrated, 5-1/2" (14 cm)
KM44220	Curved, smooth, 7" (18 cm)
KM44221	Curved, serrated, 7" (18 cm)
KM44222	Straight, smooth, 7" (18 cm)
KM44223	Straight, serrated, 7" (18 cm)

CASTROVIEJO MICRO NEEDLE HOLDERS TC



KM44210

Without lock.

ITEM #	DESCRIPTION
KM44210	Curved, serrated, 5-1/2" (14 cm), TC
KM44211	Curved, serrated, 7" (18 cm), TC
KM44212	Straight, serrated, 5-1/2" (14 cm), TC
KM44213	Straight, serrated, 7" (18 cm), TC
KM44216	Curved, smooth, 7" (18 cm), TC
KM44217	Straight, smooth, 7" (18 cm), TC

CASTROVIEJO MICRO NEEDLE HOLDERS



35559DG

Fine, straight, with round handle and lock. 1 mm Diama-Grip jaws.

ITEM #	DESCRIPTION
355558DG	9" (23 cm)
355559DG	10" (25.5 cm)
355560DG	12" (30.5 cm)

NEEDLE HOLDERS

Castro-Type Micro Needle Holders

CASTROVIEJO MICRO NEEDLE HOLDERS

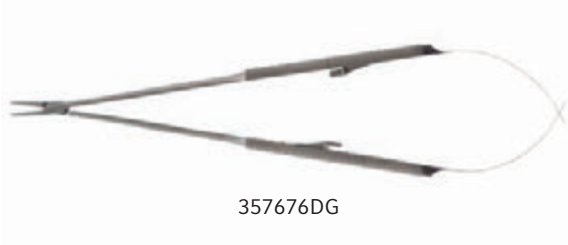

Round handle with Diama-Grip jaws.

ITEM #	DESCRIPTION
357656DG	Straight, with lock, 1.2 mm, 7" (18 cm)
357676DG	Straight, with lock, 1.2 mm, 8" (20.5 cm)
357677DG	Curved without lock, 1 mm, 8" (20.5 cm)

CASTROVIEJO NEEDLE HOLDERS



Straight, with flat handle and lock. Diama-Grip jaws.

ITEM #	DESCRIPTION
354964DG	1.8 mm, 7-1/4" (18.5 cm)
354965DG	8" (20.5 cm)

CASTROVIEJO TECHNIQUE® NEEDLE HOLDERS



ITEM #	DESCRIPTION
354964	Straight, 13 x 1.4 mm jaw, 7-1/4" (18.5 cm), TC
354965	Straight, 13 x 1.4 mm jaw, 8" (20.5 cm), TC

NEEDLE HOLDERS

Castro-Type Micro Needle Holders

MICRO SURGERY TECHNIQUE® NEEDLE HOLDERS



Flat handle, smooth jaws.

ITEM #	DESCRIPTION
354966	Straight, 13 x 1.4 mm jaw, 7" (18 cm), TC
354967	Straight, 13 x 1.4 mm jaw, 8" (20.5 cm), TC

SPENCER CORONARY TECHNIQUE® NEEDLE HOLDER



354969

ITEM #	DESCRIPTION
354969	Straight, smooth, 12 x 1.2 mm jaw, 0.9 mm tip, 7" (18 cm), TC

GIANNINI TECHNIQUE® NEEDLE HOLDER



354971

ITEM #	DESCRIPTION
354971	Straight, 17.5 x 1.8 mm jaw, 10-1/4" (26 cm), TC

JACOBSON MICRO NEEDLE HOLDER



357603DG

ITEM #	DESCRIPTION
357603DG	Straight with flat handle, lock, 18 x 1.3 mm Diamo-Grip jaw, 8-1/2" (21.5 cm)

NEEDLE HOLDERS

Castro-Type Micro Needle Holders

JACOBSON MICRO NEEDLE HOLDERS



ITEM #	DESCRIPTION
358001	Straight, round handle, with lock, 11 x 0.8 mm Diamo-grip jaw, 9" (23 cm)
358002	Straight, round handle, with lock, 1.8 mm Diamo-grip jaw, 9" (23 cm)
358003	Straight, round handle, with lock, 16 x 0.9 mm Diamo-grip jaw, 8-1/4" (21 cm)

JACOBSON MICRO-SURGICAL NEEDLE HOLDERS



Castroviejo-type lock can be removed if not required.
Stainless steel jaws.

ITEM #	DESCRIPTION
357601	Straight, flat handle, with lock, 13 x 1.3 mm smooth jaw, 7" (18 cm)
357603	Straight, flat handle, with lock, 13.5 x 1.2 mm smooth jaw, 8-1/2" (21.5 cm)

BARRAQUER MICRO NEEDLE HOLDERS



Without lock, round handle.

ITEM #	DESCRIPTION
KM44175	Straight, smooth, 5-1/2" (14 cm)
KM44171	Curved, smooth, 5-1/2" (14 cm)
KM44177	Straight, smooth, 7" (18 cm)
KM44173	Curved, smooth, 7" (18 cm)
KM44176	Straight, smooth, 5-1/2" (14 cm), TC
KM44172	Curved, smooth, 5-1/2" (14 cm), TC
KM44161	Straight, serrated, 5-1/2" (14 cm), TC
KM44159	Curved, serrated, 5-1/2" (14 cm), TC
KM44178	Straight, smooth, 7" (18 cm), TC
KM44174	Curved, smooth, 7" (18 cm), TC
KM44162	Straight, serrated, 7" (18 cm), TC
KM44160	Curved, serrated, 7" (18 cm), TC

NEEDLE HOLDERS

Castro-Type Micro Needle Holders

BARRAQUER DELICATE NEEDLE HOLDERS



With lock, round handle.

ITEM #	DESCRIPTION
KM44133	Straight, smooth, 5-1/2" (14 cm)
KM44129	Curved, smooth, 5-1/2" (14 cm)
KM44135	Straight, smooth, 7" (18 cm)
KM44131	Curved, smooth, 7" (18 cm)
KM44134	Straight, smooth, 5-1/2" (14 cm), TC
KM44130	Curved, smooth, 5-1/2" (14 cm), TC
KM44123	Straight, serrated, 5-1/2" (14 cm), TC
KM44121	Curved, serrated, 5-1/2" (14 cm), TC
KM44136	Straight, smooth, 7" (18 cm), TC
KM44132	Curved, smooth, 7" (18 cm), TC
KM44124	Straight, serrated, 7" (18 cm), TC
KM44122	Curved, serrated, 7" (18 cm), TC

BARRAQUER DELICATE NEEDLE HOLDERS



Without lock, round handle.

ITEM #	DESCRIPTION
KM44151	Straight, smooth, 5-1/2" (14 cm)
KM44137	Curved, smooth, 5-1/2" (14 cm)
KM44153	Straight, smooth, 7" (18 cm)
KM44139	Curved, smooth, 7" (18 cm)
KM44152	Straight, smooth, 5-1/2" (14 cm), TC
KM44138	Curved, smooth, 5-1/2" (14 cm), TC
KM44127	Straight, serrated, 5-1/2" (14 cm), TC
KM44125	Curved, serrated, 5-1/2" (14 cm), TC
KM44154	Straight, smooth, 7" (18 cm), TC
KM44150	Curved, smooth, 7" (18 cm), TC
KM44128	Straight, serrated, 7" (18 cm), TC
KM44126	Curved, serrated, 7" (18 cm), TC

NEEDLE HOLDERS

Wire Twisters

BAUMGARTEN WIRE TWISTER



ITEM #	DESCRIPTION
142521	Heavy square, 17.5 x 5 mm jaw, 8-1/8" (20.5 cm), TC

RUBIO TECHNIQUE® WIRE TWISTER



ITEM #	DESCRIPTION
351349	12 x 4.5 mm jaw, 5" (12.5 cm), TC

NEEDLE HOLDERS

Wire Twisters

BERRY STERNAL TECHNIQUE® NEEDLE HOLDER



A large, heavy-duty needle holder with 6 mm wide jaws designed to securely hold the large needles used to close sternotomies. LIFE-LOK® Box Lock.

ITEM #	DESCRIPTION
343030	28 x 6 mm jaw, 7-3/4" (19.5 cm), TC

WIRE FORCEPS



ITEM #	DESCRIPTION
351348	5-3/8" (13.5 cm)

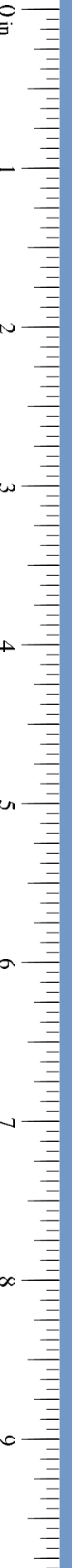

NEEDLE HOLDERS

Suture Tags

GREGORY TECHNIQUE® SUTURE "STAY" CLAMPS



Smooth jaw hemostats for tagging sutures. May be used with or without rubber shodding.

ITEM #	DESCRIPTION
351830	Straight, 3-7/8" (10 cm), TC
351831	Curved, 3-7/8" (10 cm), TC

RETRACTORS, HAND-HELD

Skin Hooks

CONVERSE SKIN HOOKS



442147

ITEM #	DESCRIPTION
442147	Small, 7-1/4" (18.5 cm)
442145	Large, 7" (18 cm)

COTTLE SKIN HOOKS



054135



054120

ITEM #	DESCRIPTION
054120	Sharp, 2 prongs, 12 mm between prongs, 5-7/8" (15 cm)
054135	Sharp, 3.5 mm hook, 4-7/8" (12.5 cm)

FLEXIBLE RAKE RETRACTOR SKIN HOOKS



KM52182

ITEM #	DESCRIPTION
KM52174	Sharp, 1 prong, 6-1/4" (16 cm)
KM52176	Sharp, 2 prongs, 6-1/4" (16 cm)
KM52182	Sharp, 3 prongs, 6-1/4" (16 cm)
KM52184	Blunt, 1 prong, 6-1/4" (16 cm)
KM52188	Blunt, 2 prongs, 6-1/4" (16 cm)
KM52192	Blunt, 3 prongs, 6-1/4" (16 cm)

FOMON RETRACTOR



054500

ITEM #	DESCRIPTION
054500	Ball tip, 2 prongs, 10 mm between prongs, 6-3/8" (16 cm)

RETRACTORS, HAND-HELD

Skin Hooks

FREER RETRACTOR



ITEM #	DESCRIPTION
481175	Sharp, 2 prongs, 5-7/8" (15 cm)

FREER SKIN HOOK



ITEM #	DESCRIPTION
KM52040	Sharp, 2 prongs, 2.5 mm wide, 6" (15 cm)

GILLIES CONVERSE SKIN HOOKS



ITEM #	DESCRIPTION
054128	Small, sharp, 3 mm hook, 7-3/8" (18.5 cm)
054130	Large, sharp, 4 mm hook, 7-1/8" (18 cm)

GUTHRIE SKIN HOOK



ITEM #	DESCRIPTION
054126	Sharp, 2 prongs, 2 mm between prongs, 5-1/8" (13 cm)

RETRACTORS, HAND-HELD

Skin Hooks

JOHNSON SKIN HOOK



054125

ITEM #	DESCRIPTION
054125	Sharp, 5 mm hook, 6-1/2" (16.5 cm)

JOSEPH SKIN HOOKS



054105

Sharp, 4 mm hook. Weck® Pattern, bright finish.

ITEM #	DESCRIPTION
054100	1 prong, 6-1/8" (15.5 cm)
054102	2 prongs, 2 mm between prongs, 6-1/4" (16 cm)
054105	2 prongs, 5 mm between prongs, 6-1/4" (16 cm)
054107	2 prongs, 6 mm between prongs, 6-1/4" (16 cm)
054110	2 prongs, 9 mm between prongs, 6-1/8" (15.5 cm)

JOSEPH SKIN HOOKS



442104

Pilling® Pattern, bright finish. 6-1/4" (16 cm).

ITEM #	DESCRIPTION
442100	1 prong
442102	2 prongs, 3 mm
442104	2 prongs, 5.5 mm
442106	2 prongs, 7 mm
442108	2 prongs, 10 mm

KLEINERT-KUTZ SKIN HOOKS



054142

Weck® Pattern, bright finish.

ITEM #	DESCRIPTION
054140	Small, 3 mm hook, 6-1/4" (16 cm)
054142	Medium, 5 mm hook, 6-1/4" (16 cm)
054144	Large, 7 mm hook, 6-1/8" (15.5 cm)

RETRACTORS, HAND-HELD

Skin Hooks

KLEINERTZ-KUTZ HOOK



KM52060

KMedic® Pattern, satin finish.

ITEM #	DESCRIPTION
KM52060	3 mm hook, 6-1/4" (16 cm)
KM52064	5 mm hook, 6-1/4" (16 cm)
KM52068	6 mm hook, 6-1/4" (16 cm)

KMEDIC® SKIN HOOK



KM52055

ITEM #	DESCRIPTION
KM52055	1 sharp prong, 2 mm hook, 4-3/4" (12 cm)

O'CONNER SKIN HOOK



164786

ITEM #	DESCRIPTION
164786	Sharp, 5-3/8" (13.5 cm)

PECK-JOSEPH SKIN HOOK

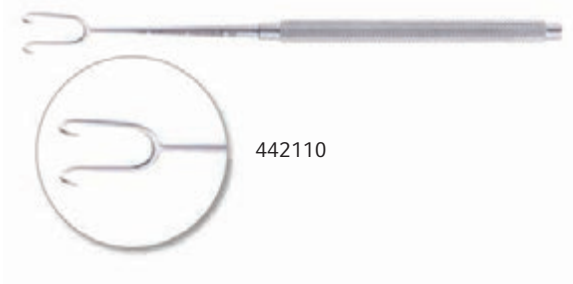

442110

ITEM #	DESCRIPTION
442110	2 prongs, 10 mm between prongs, 5-5/8" (14.5 cm)

RIGID RAKE RETRACTOR SKIN HOOKS



KM52172

6-1/2" (16.5 cm).

ITEM #	DESCRIPTION
KM52156	Sharp, 1 prong
KM52158	Sharp, 2 prongs, 6-1/2" (16.5 cm)
KM52162	Sharp, 3 prongs, 6-1/2" (16.5 cm)
KM52164	Blunt, 1 prong, 6-1/2" (16.5 cm)
KM52166	Blunt, 2 prongs, 6-1/2" (16.5 cm)
KM52172	Blunt, 3 prongs, 6-1/2" (16.5 cm)

RETRACTORS, HAND-HELD

Skin Hooks

ROLLET RETRACTOR

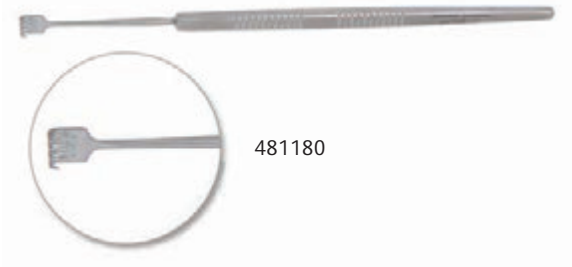

481180

ITEM #	DESCRIPTION
481180	Sharp, 4 prongs, 2.8 x 5.5 mm, 5-1/4" (13.5 cm)

SCHNITMAN SHARP SKIN HOOK WITH EYE



524230

ITEM #	DESCRIPTION
524230	6-1/2" (16.5 cm)

TYRELL HOOKS



KM54342

ITEM #	DESCRIPTION
KM54338	1 sharp prong, 5" (12.5 cm)
KM54342	1 blunt prong, 5" (12.5 cm)

TYRELL HOOKS

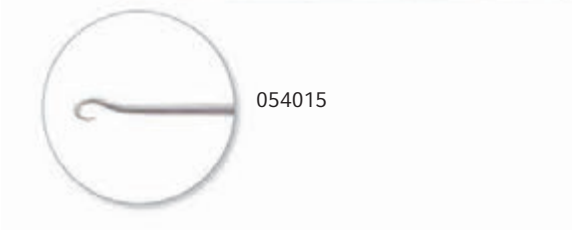

054015

Delicate, 1.3 mm hook, 4-3/4" (12 cm).

ITEM #	DESCRIPTION
054015	Sharp
054016	Blunt

WIENER SKIN HOOKS



KM54346

Single hook, 5" (12.5 cm).

ITEM #	DESCRIPTION
KM54346	Sharp
KM54348	Blunt

RETRACTORS, HAND-HELD

Hook and Rake Retractors

DANDY NERVE HOOK



185714

ITEM #	DESCRIPTION
185714	Straight, 5.1 mm hook, 9" (23 cm)

SISSON NERVE HOOK



060120

ITEM #	DESCRIPTION
060120	Blunt, 90 degree angled, 7 mm hook, 6-1/8" (15.5 cm)

JACKSON TRACHEAL TENACULUM



514413

ITEM #	DESCRIPTION
514413	Hook depth 1/4" (0.5 cm), 5-1/4" (13.5 cm)

NEWS TRACHEA RETRACTOR



070114

ITEM #	DESCRIPTION
070114	Sharp, 10 mm hook, 5-7/8" (15 cm)

RETRACTORS, HAND-HELD

Hook and Rake Retractors

TRACHEA HOOK



ITEM #	DESCRIPTION
054165	Sharp, 8.7 x 1.4 mm hook, 7-1/2" (19 cm)
KM52098	Hupp Trachea Hook, sharp, 6-1/2" (16.5 cm)

SOLVAY SPAY HOOK



ITEM #	DESCRIPTION
801886	8" (20.5 cm)

JACKSON TRACHEAL RETRACTOR, DOUBLE ENDED



Pilling® Pattern, satin finish.

ITEM #	DESCRIPTION
514414	Double-pronged, 1" wide x 1/4" deep (2.5 cm x 0.5 cm) blade, 6-7/8" (17.5 cm)

RETRACTORS, HAND-HELD

Hook and Rake Retractors

JACKSON TRACHEA RETRACTOR



Weck® Pattern, bright finish.

ITEM #	DESCRIPTION
070116	2 prongs, 7" (18 cm)

DINGMAN ZYGOMA HOOK



ITEM #	DESCRIPTION
026275	Sharp, 13 mm hook, 7" (18 cm)

BERNAY FINGER RAKE TRACHEAL RETRACTORS



ITEM #	DESCRIPTION
514430	1 prong, sharp, 6-5/8" (17 cm)
514431	2 prongs, sharp, 6-5/8" (17 cm)
514433	3 prongs, sharp, 6-5/8" (17 cm)
514435	1 prong, blunt, 6-5/8" (17 cm)
514436	2 prongs, blunt, 6-5/8" (17 cm)
514437	3 prongs, blunt, 6-5/8" (17 cm)
514438	4 prongs, blunt, 6-5/8" (17 cm)

LAHEY FINGER RETRACTORS



ITEM #	DESCRIPTION
KM52082	1 prong, 4-3/4" (12 cm)
KM52086	2 sharp prongs, 5" (12.5 cm)
KM52087	3 sharp prongs, 5" (12.5 cm)

RETRACTORS, HAND-HELD

Hook and Rake Retractors

BLAIR (ROLLET) RETRACTOR



KM54368

ITEM #	DESCRIPTION
KM54366	Rigid, 4 sharp prongs, 6 mm wide blade, 5" (12.5 cm)
KM54368	Rigid, 4 blunt prongs, 5 mm wide blade, 5" (12.5 cm)
KM54372	Flexible, 4 sharp prongs, 5-1/2" (14 cm)

MURPHY RAKE RETRACTORS



164444



164454

ITEM #	DESCRIPTION
164443	Sharp, 3 prongs, 7-3/4" (19.5 cm)
164444	Sharp, 4 prongs, 8" (20.5 cm)
164446	Sharp, 6 prongs, 7-7/8" (20 cm)
164453	Blunt, 3 prongs, 8" (20.5 cm)
164454	Blunt, 4 prongs, 8" (20.5 cm)
164456	Blunt, 6 prongs, 7-3/4" (19.5 cm)

VOLKMANN POCKET RETRACTORS



164374

ITEM #	DESCRIPTION
164374	Sharp, 4 prongs, 4-1/2" (11.5 cm)
164376	Sharp, 6 prongs, 4-1/2" (11.5 cm)
164384	Blunt, 4 prongs, 4-1/2" (11.5 cm)

RETRACTORS, HAND-HELD

Hook and Rake Retractors

VOLKMANN RAKE RETRACTORS



164403



164414

Pilling® Pattern, satin finish.

ITEM #	DESCRIPTION
164402	Sharp, 2 prongs, 8-1/2" (21.5 cm)
164403	Sharp, 3 prongs, 8-1/2" (21.5 cm)
164404	Sharp, 4 prongs, 8-1/2" (21.5 cm)
164406	Sharp, 6 prongs, 8-1/2" (21.5 cm)
164412	Blunt, 2 prongs, 8-1/2" (21.5 cm)
164413	Blunt, 3 prongs, 8-1/2" (21.5 cm)
164414	Blunt, 4 prongs, 8-1/2" (21.5 cm)
164416	Blunt, 6 prongs, 8-1/2" (21.5 cm)

VOLKMAN RETRACTORS



KM52264

KMedic® Pattern, satin finish. Sharp.

ITEM #	DESCRIPTION
KM52266	6 prongs, 1-1/8" wide x 1/2" deep blade (3 x 1.5 cm), 8-1/2" (21.5 cm)
KM52254	1 prong, 1/2" deep blade (15 mm), 8-1/2" (21.5 cm)
KM52264	4 prongs, 3/4" wide x 1/2" deep blade (18 x 13 mm), 8-1/2" (21.5 cm)

MUELLER RAKE RETRACTOR



KM52338

ITEM #	DESCRIPTION
KM52338	8 prongs, 1-1/2" (38 mm) wide

DEEP RAKE RETRACTORS



KM52294

ITEM #	DESCRIPTION
KM52292	4 blunt prongs, 2-1/4" wide x 1-1/2" deep (5.5 x 4 cm)
KM52294	4 blunt prongs, 2-1/4" wide x 2" deep (5.5 x 5 cm)
KM52296	4 blunt prongs, 2-1/4" wide x 2-1/2" deep (5.5 x 6.5 cm)
KM52298	4 blunt prongs, 2-1/4" wide x 3" deep (5.5 x 7.5 cm)

RETRACTORS, HAND-HELD

Hook and Rake Retractors

ISRAEL RETRACTOR



ITEM #	DESCRIPTION
481390	Blunt, 4 prongs, 41 x 43 mm, 7-3/8" (18.5 cm)

OLLIER RAKE RETRACTOR



ITEM #	DESCRIPTION
KM52282	4 blunt prongs, 5.5 cm wide x 4 cm deep blade, 9" (23 cm)

FREEMAN FACE LIFT RETRACTOR



ITEM #	DESCRIPTION
442295	1-5/8" (4 cm) wide blade, 7-1/8" (18 cm)



RETRACTORS, HAND-HELD

Single-Ended Retractors

BREWSTER RETRACTORS



Curved, convex blades.

ITEM #	DESCRIPTION
164650	3/4" x 1-3/4" (2 x 4.5 cm) blade, 8-1/2" (21.5 cm)
164652	1" x 2" (2.5 x 5 cm) blade, 9" (23 cm)
164656	1-3/4" x 2-1/2" (4.5 x 6.5 cm) blade, 9-1/4" (23.5 cm)
164658	1-7/8" x 2-7/8" (5 x 7.5 cm) blade, 9-1/2" (24 cm)

COTTLE ALAR RETRACTOR



ITEM #	DESCRIPTION
442210	1/2" (1.5 cm) wide blade, 5-1/2" (14 cm)

CUSHING DECOMPRESSION RETRACTOR



ITEM #	DESCRIPTION
481220	21 x 10 mm blade, 8-1/8" (20.5 cm)

RETRACTORS, HAND-HELD

Single-Ended Retractors

CUSHING NERVE AND VEIN RETRACTOR

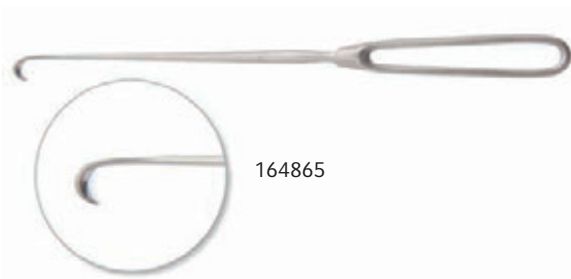

Pilling® Pattern, satin finish.

ITEM #	DESCRIPTION
164865	12 mm wide blade, 8-1/2" (21.5 cm)

CUSHING NERVE AND VEIN RETRACTORS



Weck® Pattern, bright finish.

ITEM #	DESCRIPTION
481230	16 x 15 mm blade, 8-5/8" (22 cm)
481231	14.5 x 15 mm blade, 12-3/4" (32.5 cm)

DESMARRES LID RETRACTORS



ITEM #	DESCRIPTION
421610	Size 1, 12 mm wide blade, 5-3/8" (13.5 cm)
421620	Size 2, 13 mm wide blade, 5-3/8" (13.5 cm)
421630	Size 3, 15 mm wide blade, 5-3/8" (13.5 cm)
421640	Size 4, 17 mm wide blade, 5-3/8" (13.5 cm)

GREEN RETRACTOR



ITEM #	DESCRIPTION
481520	Fenestrated, 21 x 24 mm blade, 8-7/8" (22.5 cm)

RETRACTORS, HAND-HELD

Single-Ended Retractors

LAHEY RETRACTOR



ITEM #	DESCRIPTION
481610	30 x 5 mm blade, 7-3/4" (19.5 cm)

LANGENBECK RETRACTORS



Distal blade tip, slightly curved. Flat handle.
Length 8-1/2" (21.5 cm).

ITEM #	DESCRIPTION
164630	3/8" x 1-5/8" (1 x 4 cm) blade
164631	1/2" x 1-5/8" (1.3 x 4 cm) blade
164632	5/8" x 1-5/8" (1.5 x 4 cm) blade

LITTLE RETRACTOR



ITEM #	DESCRIPTION
481500	Curved, 20 x 12 mm blade, 7-1/2" (19 cm)

RETRACTORS, HAND-HELD

Single-Ended Retractors

LOVE NERVE RETRACTORS



ITEM #	DESCRIPTION
KM51530	Straight, 7 mm wide blade, 8-1/2" (21.5 cm)
KM51532	Angled 45 degrees, 7 mm wide blade, 7" (18 cm)
KM51534	Angled 90 degrees

LOVE NERVE RETRACTORS

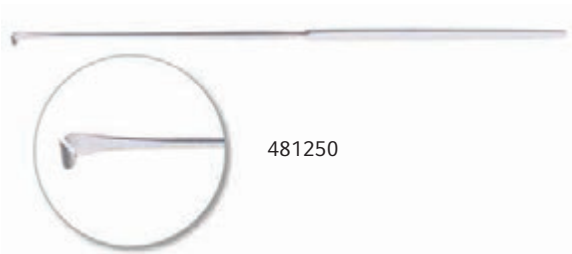

ITEM #	DESCRIPTION
481250	4 x 6 mm blade, straight, 8" (20.5 cm)

MCBURNEY RETRACTOR



ITEM #	DESCRIPTION
481530	Fenestrated, 20 x 16 mm blade, 7-5/8" (19.5 cm)



RETRACTORS, HAND-HELD

Single-Ended Retractors

MEYERDING FINGER RETRACTORS



Pilling® Pattern, satin finish.

ITEM #	DESCRIPTION
164790	7.5 x 17 mm blade, 6-7/8" (17.5 cm)

MEYERDING FINGER RETRACTORS



KMedic® Pattern, satin finish, 7" (18 cm).

ITEM #	DESCRIPTION
KM52116	#1, 7 mm wide x 18 mm deep blade
KM52118	#2, 6 mm wide x 17 mm deep blade, with teeth
KM52122	#3, 4 mm wide x 8 mm deep blade, with teeth
KM52124	#4, 4 mm wide x 10 mm deep blade
KM52128	#5, 4 mm wide x 7 mm deep blade
KM52130	#6, 8 mm wide x 7 mm deep blade, 3 sharp prongs



RETRACTORS, HAND-HELD

Single-Ended Retractors

SAUERBRUCH RETRACTORS



Long, slender blades with slightly curved tips.
Hollow handle.

ITEM #	DESCRIPTION
164635	5/8" x 1-3/4" (1.5 x 4.5 cm) blade, 9" (23 cm)
164636	7/8" x 2-1/2" (2 x 6.5 cm) blade, 9" (23 cm)
164637	3/4" x 2-7/8" (2 x 7.5 cm) blade, 8-7/8" (22.5 cm)

SEMB RETRACTOR



For retracting the muscles during resection of the posterior medial ends of the ribs and during freeing of the transverse processes and separation of the vertebrocostal joints. Stainless steel blade.

ITEM #	DESCRIPTION
341640	Small, blade 3/4" wide x 1-3/4" deep (2 x 4.5 cm)

Double-Ended Retractors

"S" RETRACTOR



ITEM #	DESCRIPTION
054620	Blade A 1/4" wide x 3/8" deep (6 x 10 mm), Blade B 1/2" wide x 5/8" deep (13.5 x 15 mm) Overall length 5-1/4" (13.5 cm)

RETRACTORS, HAND-HELD

Double-Ended Retractors

KLEINERT-RAGNELL RETRACTOR



ITEM #	DESCRIPTION
442260	Blade A 1/4" wide x 3/4" deep (5.6 x 20 mm), Blade B 1/8" wide x 3/8" deep (3.7 x 10 mm), Overall length 6-1/8" (15.5 cm)

BREWSTER PHRENIC RETRACTORS



Nested set of 2.

ITEM #	DESCRIPTION
341635	Large blade 1-3/8" x 1-1/2" wide (20 x 40 mm) x 1-3/8" deep (35 mm), Small blade 1" wide x 3/8" deep (25 x 10 mm), Overall length 5-7/8" (15 cm)

CHILDREN'S HOSPITAL RETRACTOR



ITEM #	DESCRIPTION
164754	Blade A 3/8" wide x 3/4" deep (10 x 19 mm), Blade B 1/4" wide x 3/4" deep (6 x 19 mm), Overall length 6-1/8" (15.5 cm)

RETRACTORS, HAND-HELD

Double-Ended Retractors

CRILE RETRACTOR

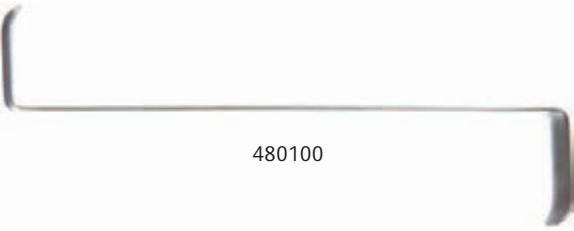

480100

ITEM #	DESCRIPTION
480100	Large blade 1/4" wide x 3/4" deep (7.5 x 20 mm), Small blade 1/4" wide x 5/8" deep (5 x 17 mm), Overall length 4-1/8" (10.5 cm)

DAVIS RETRACTORS



442245

ITEM #	DESCRIPTION
442245	Blade A 3/8" wide (10 mm), Blade B 1/4" wide (6 mm), Overall length 6-1/8" (15.5 cm)

DAVIS RETRACTORS



KM52076

ITEM #	DESCRIPTION
KM52076	Blade A 1/4" wide x 5/8" deep blade (6 x 17 mm), Blade B 3/8" wide x 3/4" deep blade (9 x 20 mm), Overall length 6" (15 cm)

FARABEUF RETRACTORS



164702

Nested set of 2.

ITEM #	DESCRIPTION
164700	Blade A 5/8" wide x 1-1/8" deep (15 x 28 mm), Blade B 5/8" wide x 1-1/4" deep (15 x 30 mm), Overall length 6" (15 cm)
164702	Blade A 3/8" wide x 1" deep (10 x 25 mm), Blade B 1/2" wide x 1-1/4" deep (12 x 30 mm), Overall length 4-1/2" (11.5 cm)

RETRACTORS, HAND-HELD

Double-Ended Retractors

GOELET RETRACTOR



480150

ITEM #	DESCRIPTION
480150	Blade A 1" wide x 1-1/8" deep (26 x 30 mm), Blade B 1-1/4" wide x 1-7/8" deep (31 x 47 mm), Overall length 7-1/2" (19 cm)

INFANT RETRACTOR



480105

ITEM #	DESCRIPTION
480105	Blades 3/8" x 1/2" (10 x 13 mm), 5-5/8" (14.5 cm)

LUKENS THYMUS RETRACTOR



514412

ITEM #	DESCRIPTION
514412	Blade 3/8" wide x 1/4" deep (9 x 6 mm), Overall length 6-7/8" (17.5 cm)

MAYO-COLLINS RETRACTORS



164710

Nested set of 2.

ITEM #	DESCRIPTION
164710	Blade A 3/4" wide x 1-1/8" deep (20 x 30 mm), Blade B 3/4" wide x 1-1/4" deep (20 x 35 mm), Overall length 6" (15 cm)

RETRACTORS, HAND-HELD

Double-Ended Retractors

PARKER RETRACTORS



480170

ITEM #	DESCRIPTION
480170	Small set of 2 retractors. Short retractor: Blade A 7/8" wide x 5/8" deep (21 x 16 mm), Blade B 1" wide x 5/8" deep (25 x 16 mm), Overall length 5-1/2" (14 cm)
480172	Large set of 2 retractors. Short retractor: Blade A 1" wide x 1" deep (25 x 24 mm), Blade B 1" wide x 1" deep (26 x 24 mm), Overall length 6-3/4" (17 cm)

PARKER-MOTT RETRACTORS



164698

Set of 2.

ITEM #	DESCRIPTION
164698	1" x 2-1/2" (25 x 65 mm) blades, Overall length 5-3/4" (14.5 cm)

RAGNELL RETRACTOR



054600

ITEM #	DESCRIPTION
054600	Blade A 3 mm wide x 8 mm deep, Blade B 5 mm wide x 17 mm deep, Overall length 5-3/4" (14.5 cm)

RETRACTORS, HAND-HELD

Double-Ended Retractors

RAGNELL RETRACTOR



KM52094

KMedic® Pattern, satin finish.

ITEM #	DESCRIPTION
KM52094	Blade A 4 wide x 8 mm deep, Blade B 6 wide x 15 mm deep, Overall length 5-3/4" (14.5 cm)

ROUX RETRACTORS



480140

7-1/4" (18.5 cm).



480145

ITEM #	DESCRIPTION
480140	Small: Blade A 1-1/8" wide x 1" deep (27 x 25 mm), Blade B 1-3/8" wide x 1-1/2" deep (34 x 38 mm)
480145	Large: Blade A 1-1/4" wide x 1-3/8" deep (31 x 36 mm), Blade B 1-1/4" wide x 1-7/8" deep (31 x 47 mm)

SENN RETRACTORS



164750

Pilling® Pattern, satin finish. 1/4" x 3/4" (6 x 19 mm) flat blade, 6-1/4" (16 cm).

ITEM #	DESCRIPTION
164750	3 sharp prongs
164752	3 blunt prongs

SENN-KANAVEL DELICATE RETRACTOR



054590

ITEM #	DESCRIPTION
054590	3 sharp 7 x 7 mm prongs, 21 x 6 mm blade, 6-1/2" (16.5 cm)

RETRACTORS, HAND-HELD

Double-Ended Retractors

MILLER-SENN RETRACTORS



9.8 mm prongs, 21 x 6.5 mm blade, 6-1/2" (16.5 cm).

ITEM #	DESCRIPTION
480125	3 sharp prongs
480126	3 blunt prongs

U.S. ARMY (ARMY-NAVY) RETRACTORS

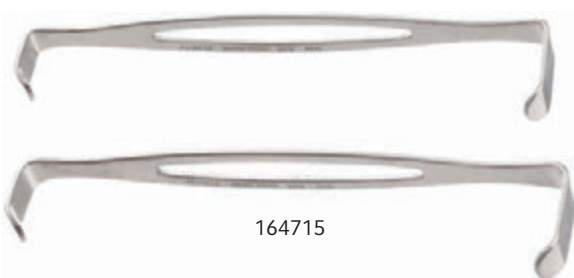

Nested set of 2.

ITEM #	DESCRIPTION
164715	5/8" (1.5 cm) wide blade, 8-1/2" (21.5 cm)

Abdominal-Type Retractors

DEAVER RETRACTORS



Hollow grip handle.

ITEM #	DESCRIPTION
KM51230	1" wide x 10" long blade (2.5 x 25.5 cm)
KM51232	1" wide x 12" long blade (2.5 x 30.5 cm)
KM51234	1" wide x 13" long blade (2.5 x 33 cm)
KM51240	2" wide x 12" long blade (5 x 30.5 mm)
KM51236	2-1/2" wide x 14-1/2" long blade (6.5 x 37 cm)
KM51242	3" wide x 12" long blade (7.5 x 30.5 cm)
KM51238	3-1/2" wide x 12" long blade (9 x 30.5 cm)



RETRACTORS, HAND-HELD

Abdominal-Type Retractors

DEAVER RETRACTORS

Standard design. Rigid stainless steel.

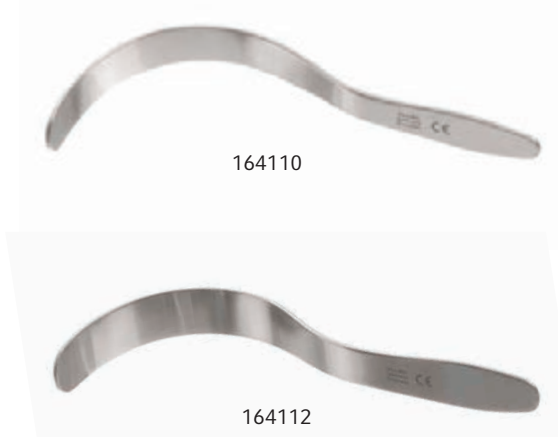

ITEM #	DESCRIPTION
164110	3/4" (2 cm) wide, 6-7/8" (17.5 cm)
164112	7/8" (2 cm) wide, 7-7/8" (20 cm)
164115	1" (2.5 cm) wide, 8-7/8" (22.5 cm)
164118	#1, 1" (2.5 cm) wide, 8-1/8" (20.5 cm)
164120	#2, 1" (2.5 cm) wide, 9-7/8" (25 cm)
164122	#3, 1" (2.5 cm) wide, 12" (30.5 cm)
164125	#4, 1" (2.5 cm) wide, 14-3/8" (36.5 cm)
164130	#5, 1-1/2" (4 cm) wide, 11-7/8" (30 cm)
164132	#6, 2" (5 cm) wide, 12" (30.5 cm)
164134	#7, 3" (7.5 cm) wide, 12" (30.5 cm)

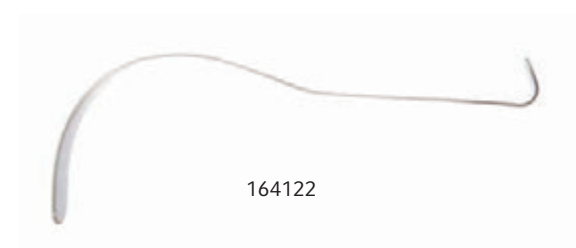

RETRACTORS, HAND-HELD

Abdominal-Type Retractors

W.M. LEMMON EXTRA DEEP DEAVER RETRACTORS



341732

Distal blade section extended to provide working depth of 9-1/2" (24 cm). Blade length 15" (38 cm). Large fluted handles.

ITEM #	DESCRIPTION
341730	1" (2.5 cm) wide blade
341732	2" (5 cm) wide blade

WILLAUER-DEAVER RETRACTORS



341722

Deaver blades mounted on comfortable handle.

ITEM #	DESCRIPTION
341720	Narrow, 1" wide x 6-1/4" deep (2.5 x 16 cm) blade, 14-1/2" (37 cm)
341722	Wide, 2" wide x 6-1/4" deep (5 x 16 cm) blade, 14-1/2" (37 cm)

DEEP DEAVER RETRACTORS



481826

Stainless steel, hollow handle.

ITEM #	DESCRIPTION
481825	6" deep x 1-1/2" (15 x 4 cm) blade, 13-3/4" (35 cm)
481826	6" deep x 2" (15 x 5 cm) blade, 13-3/4" (35 cm)
481827	6" deep x 2-1/2" (15 x 6.5 cm) blade, 13-3/4" (35 cm)

RETRACTORS, HAND-HELD

Abdominal-Type Retractors

DOYEN RETRACTORS

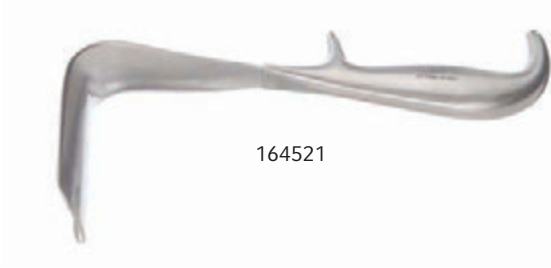

Concave blade.

ITEM #	DESCRIPTION
164520	1-3/4" x 2-3/4" blade (4.5 x 7 cm), 8-3/4" (22 cm)
164521	2-3/8" x 3-3/8" blade (6 x 8.5 cm), 9" (23 cm)
164522	2-1/4" x 3-7/8" blade (5.5 x 10 cm), 9" (23 cm)

DEBAKEY®-COOLEY RETRACTOR



Extra deep retractor of greater than usual width. Blade is carefully proportioned to provide maximum working depth and to prevent tendency toward slipping upward and out. Satin finish to prevent glare from overhead lights.

ITEM #	DESCRIPTION
341740	7-1/4" (18.5 cm) deep blade with 2-1/4" (5.5 cm) Harrington end, 12-1/4" (31 cm)

HARRINGTON EXTRA DEEP RETRACTORS



Extra deep with fluted handle, satin finish.

ITEM #	DESCRIPTION
341790	2-1/4" wide x 8" deep blade (5.5 x 20.5 cm), 11-3/4" (30 cm)
341791	4-1/2" wide x 7" deep blade (11.5 x 18 cm), 13-1/8" (33.5 cm)

HARRINGTON RETRACTORS



Stainless steel, hollow handle.

ITEM #	DESCRIPTION
482370	135 x 44 mm blade, 12-3/4" (32.5 cm)
482371	135 x 65 mm blade, 13" (33 cm)

RETRACTORS, HAND-HELD

Abdominal-Type Retractors

HARRINGTON SPLANCHNIC RETRACTORS



Cross serrated retracting surface.

ITEM #	DESCRIPTION
341770	1-1/2" wide x 4-3/4" deep blade (4 x 12 cm), 12-1/2" (32 cm)
341773	2-1/2" wide x 5" deep blade (6.5 x 12.5 cm), 12" (30.5 cm)

KELLY RETRACTORS



Flat blade with slight upward turn on sides and downward turn on slightly reduced width distal edge.

ITEM #	DESCRIPTION
KM51222	3" x 2-1/2" blade (76 x 64 mm), 9-3/4" (25 cm)
164525	1-1/2" x 2" blade (38 x 50 mm), 9" (23 cm)
164526	2" x 2-3/8" blade (50 x 61 mm), 9-1/2" (24 cm)
164527	2-1/2" x 3" blade (64 x 76 mm), 10" (25.5 cm)
164528	3" x 3-1/2" blade (76 x 90 mm), 10-1/2" (26.5 cm)

MAYO ABDOMINAL RETRACTOR



ITEM #	DESCRIPTION
482350	40 x 70 mm blade, 11" (28 cm)

RICHARDSON APPENDECTOMY RETRACTOR



ITEM #	DESCRIPTION
164540	3/4" wide x 2" deep blade (2 x 5 cm), 9-1/2" (24 cm)

RETRACTORS, HAND-HELD

Abdominal-Type Retractors

RICHARDSON RETRACTORS



164543

Blade face is relatively flat with lateral edges curved upwards. Distal edge is straight across and turned downward.

ITEM #	DESCRIPTION
164542	3/4" x 1-1/4" blade (20 x 32 mm), length 9-3/4" (25 cm)
164543	1" x 1-1/4" blade (25 x 32 mm), length 9-3/4" (25 cm)
164544	1-1/2" x 1-1/2" blade (38 x 38 mm), length 9-3/4" (25 cm)

RICHARDSON RETRACTORS



481618

481629

Stainless steel, hollow handle.

ITEM #	DESCRIPTION
481616	1" x 3/4" blade (25 x 20 mm), 9-1/2" (24 .5 cm)
481617	1-1/4" x 1-1/4" blade (32 x 32 mm), 9-1/2" (24 .5 cm)
481618	1-1/2" x 1-1/2" blade (38 x 38 mm), 9-1/2" (24 .5 cm)
481629	2" x 3/4" blade (48 x 20 mm), 9-1/2" (24 .5 cm)

RICHARDSON-EASTMAN RETRACTORS



164550

Pilling® Pattern, satin finish.

ITEM #	DESCRIPTION
164550	Set of 2: Small 10" (25.5 cm), blade A 33 x 30 mm, blade B 26 x 23 mm Large 10-3/4" (27.5 cm), blade A 65 x 43 mm, blade B 42 x 38 mm

RETRACTORS, HAND-HELD

Abdominal-Type Retractors

RICHARDSON-EASTMAN RETRACTORS



ITEM #	DESCRIPTION
480195	Set of 2: Small 9-7/8" (25 cm), blade A 30 x 29 mm, blade B 24 x 22 mm. Large 10-5/8" (27 cm) blade A 63 x 42 mm, blade B 39 x 37 mm. Weck® Pattern, bright finish.
480196	Small only: 9-7/8" (25 cm), blade A 30 x 29 mm, blade B 24 x 22 mm. Weck® Pattern, bright finish.
KM51214	Large only: 10-5/8" (27 cm), blade A 65 x 43 mm, blade B 39 x 38 mm. Satin finish.

WYLIE RENAL VEIN RETRACTORS



Designed for the retraction of the left renal vein during procedures on the abdominal aorta or renal arteries. Gently curved distal tip for atraumatic control. Stainless Steel.

ITEM #	DESCRIPTION
341795	Short, 1" wide x 3-3/4" deep (2.5 x 9.5 cm) blade, 11-3/4" (30 cm)
341797	Long, 1" wide x 6-7/8" deep (2.5 x 17.5 cm) blade, 12-3/4" (32.5 cm)

WYLIE SPLANCHNIC RETRACTOR



ITEM #	DESCRIPTION
341780	Rigid, acutely curved blade is 6-3/4" deep (17 cm). Distal 1/2" is angled inward and deeply cross serrated, which provides positive, non-slip traction. Blade is 2-1/2" wide (6.3 cm). Large, fluted handle. Overall length 13"

RETRACTORS, HAND-HELD

Ribbon-Type Malleable Retractors

DAVIS BRAIN SPATULAS



380206

ITEM #	DESCRIPTION
380200	1/4" (6.5 mm) wide blade
380202	3/8" (9.5 mm) wide blade
380204	1/2" (12.5 mm) wide blade
380206	5/8" (16 mm) wide blade
380208	3/4" (19 mm) wide blade
380210	1" (25.5 mm) wide blade

HAIGHT RETRACTORS



341694

Malleable "T"-shaped blades. For abdominal and intra-thoracic surgery.

ITEM #	DESCRIPTION
341690	3" wide x 11-1/2" long (7.5 x 29 cm)
341692	3-1/2" wide x 11-3/4" long (9 x 30 cm)
341694	4" wide x 12" long (10 x 30.5 cm)
341696	4-3/4" wide x 12-3/4" long (12 x 32.5 cm)
341698	5-1/2" wide x 13-1/2" long (14 x 34.5 cm)

OCHSNER RIBBON RETRACTORS



164170

Malleable.

ITEM #	DESCRIPTION
164164	1" x 13" (2.5 x 33 cm)
164166	1-1/4" x 13" (3 x 33 cm)
164168	1-1/2" x 13" (4 x 33 cm)
164170	2" x 13" (5 x 33 cm)
164172	2-1/2" x 13" (6.5 x 33 cm)
164174	3" x 13" (7.5 x 33 cm)
442288	7/8" x 7" (2 x 18 cm)

RIBBON RETRACTORS



KM51766

Malleable.

ITEM #	DESCRIPTION
KM51752	1/2" (12.5 mm) wide blade, 6" (15 cm)
KM51755	1" (25.5 mm) wide blade, 7-1/2" (19 cm)
KM51766	3/4" (19 mm) wide blade, 13" (33 cm)

RETRACTORS, HAND-HELD

Specialty Retractors

ALLISON LUNG RETRACTORS



341679

Wire, spatula-shaped blade.

ITEM #	DESCRIPTION
341678	Child size, 10-1/4" (26 cm)
341679	Adult Size, 12-3/8" (31.5 cm)

DAVIDSON SCAPULA RETRACTORS



341650

ITEM #	DESCRIPTION
341650	Small size, blade 2" (5 cm) wide, 7-3/4" (19.5 cm)
341651	Large size, blade 3-1/2" (9 cm) wide, 7-3/4" (19.5 cm)

DEVINE-MILLARD-AUFRECHT NASAL RETRACTOR FIBEROPTIC LIGHTING



525150

ITEM #	DESCRIPTION
525150	7-3/4" (19.5 cm)

FACE LIFT RETRACTOR FIBEROPTIC LIGHTING ON #2 DEEVER RETRACTOR



525215

ITEM #	DESCRIPTION
525215	10-5/8" (27 cm)

RETRACTORS, SELF-RETAINING

Wire and Alm-Type Retractors

BARRAQUER WIRE SPECULUMS

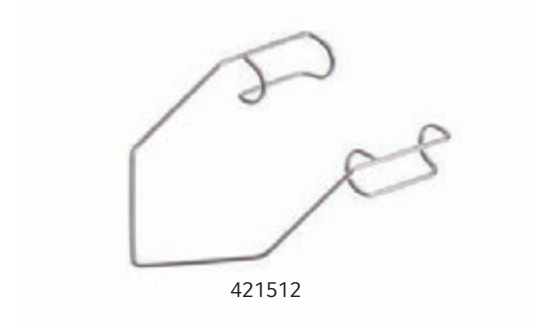

All blades 3/16" (5 mm) deep.

ITEM #	DESCRIPTION
421510	Small fenestrated blade, 3/8" wide (4 mm), overall length 1-1/8" (3 cm)
421512	Large fenestrated blade, 5/8" wide (16 mm), overall length 1-5/8" (4 cm)

FARR RETRACTORS

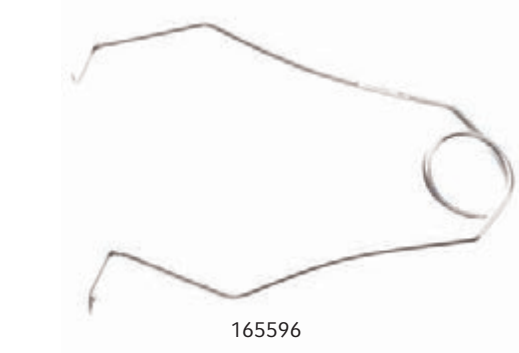

ITEM #	DESCRIPTION
165595	No. 1, blade 3/4" (2 cm), 5-1/2" (14 cm)
165596	No. 2, blade 1-1/8" (3 cm), 5-1/2" (14 cm)
165597	No. 3, blade 1-1/8" (3 cm), 9" (23 cm)

GRIESHABER WIRE RETRACTORS



Useful for very small incisions in minor surgery and in laboratory uses.

ITEM #	DESCRIPTION
165590	#1, delicate, thin wire, 1 prong, 3-1/4" (8.5 cm)
165591	#2, delicate, thin wire, 3-tooth blade, 3-1/4" (8.5 cm)
165592	#3, medium weight wire, single short prong, 4-3/4" (12 cm)
351685	Deep arteriotomy spring retractor, 3-1/4" (8.5 cm)

RETRACTORS, SELF-RETAINING

Wire and Alm-Type Retractors

HEISS RETRACTORS



ITEM #	DESCRIPTION
165085	4 x 4 sharp prongs, 1/8" (3 mm) deep, 4-1/8" (10.5 cm)
165086	4 x 4 blunt prongs, 1/8" (3 mm) deep, 4-1/8" (10.5 cm)

SKIN SELF-RETAINING RETRACTORS

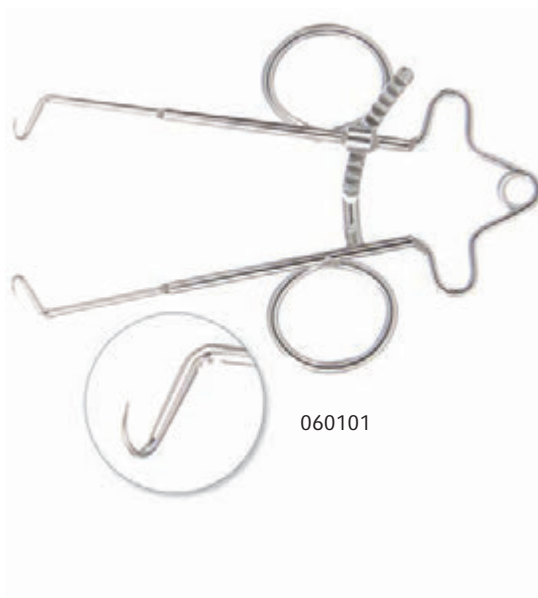

ITEM #	DESCRIPTION
060100	Sharp prongs, lightly angled 55 degrees, 2-1/2" (6.5 cm) spread, 3-3/4" (9.5 cm)
060101	Sharp prongs, strongly angled 80 degrees, 2-1/2" (6.5 cm) spread, 3-1/2" (9 cm)
060105	Sharp prongs, strongly angled 80 degrees, 3-1/2" (9 cm) spread, 4-3/4" (12 cm)

ALM RETRACTORS



For delicate minor surgery.

ITEM #	DESCRIPTION
165510	Small, 4 mm, semi-sharp teeth, 2-3/4" (7 cm)
488210	4 x 4 blunt prongs, 3" (7.5 cm)

RETRACTORS, SELF-RETAINING

Wire and Alm-Type Retractors

JANSEN RETRACTORS



165550

ITEM #	DESCRIPTION
165550	3 x 3 blunt prongs, 5/16" (8 mm) deep, 3" (7.5 cm) spread, 4-3/8" (11 cm)
165552	3 x 3 sharp prongs, 5/16" (8 mm) deep, 2" (5 cm) spread, 4-3/8" (11 cm)

Weitlaner, Gelpi and Henly-Type Retractors

WEITLANER RETRACTORS



165352



165362

Pilling® Pattern, satin finish.

ITEM #	DESCRIPTION
165348	2 x 3 sharp prongs, 4-1/2" (11.5 cm)
165350	3 x 4 sharp prongs, 5-1/2" (14 cm)
165352	3 x 4 sharp prongs, 6-1/2" (16.5 cm)
165354	3 x 4 sharp prongs, 7-5/8" (19.5 cm)
165356	3 x 4 sharp prongs, 9-1/2" (24 cm)
165358	2 x 3 blunt prongs, 4-1/2" (11.5 cm)
165360	3 x 4 blunt prongs, 5-1/2" (14 cm)
165362	3 x 4 blunt prongs, 6-1/2" (16.5 cm)
165364	3 x 4 blunt prongs, 7-5/8" (19.5 cm)
165366	3 x 4 blunt prongs, 9-1/2" (24 cm)

RETRACTORS, SELF-RETAINING

Weitlaner, Gelpi and Henly-Type Retractors

WEITLANER RETRACTORS



Weck® Pattern, bright finish.

ITEM #	DESCRIPTION
488305	2 x 3 sharp prongs, 4-1/2" (11.5 cm)
488306	2 x 3 blunt prongs, 4-1/2" (11.5 cm)

WEITLANER RETRACTORS



KMedic® Pattern, satin finish.

ITEM #	DESCRIPTION
KM52492	2 x 3 sharp prongs 12 x 16 mm, 4" (10 cm)
KM52494	2 x 3 blunt prongs 13 mm, 4" (10 cm)
KM52498	3 x 4 sharp prongs, 5-1/4" (13.5 cm)

WULLSTEIN-WEITLANER RETRACTORS



ITEM #	DESCRIPTION
029550	Small, 3 x 3 sharp prongs, 11 mm deep x 12 mm wide, 4-3/8" (11 cm)
029555	Large, 3 x 3 sharp prongs, 11 mm deep x 12 mm wide, 5" (12.5 cm)

RETRACTORS, SELF-RETAINING

Weitlaner, Gelpi and Henly-Type Retractors

SCALP CONTOUR RETRACTORS



KM52546

Useful in hand procedures because handle is not obstructive.

ITEM #	DESCRIPTION
KM52546	3 x 4 blunt prongs, 5-1/2" (14 cm)
KM52548	3 x 4 sharp prongs, 5-1/2" (14 cm)

ADSON RETRACTORS



488361

Straight shanks.

ITEM #	DESCRIPTION
488360	4 x 4 sharp prongs, 7-1/2" (19 cm)
488361	4 x 4 blunt prongs, 7-1/2" (19 cm)

ADSON RETRACTORS



382722

Contoured shanks.

ITEM #	DESCRIPTION
382722	4 x 4, sharp, 17 x 7 mm prongs, 7-1/4" (18.5 cm)

RETRACTORS, SELF-RETAINING

Weitlaner, Gelpi and Henly-Type Retractors

ANDERSON ADSON RETRACTOR



Angled shanks.

ITEM #	DESCRIPTION
382710	4 x 4 blunt, 17 x 7 mm prongs, 6-3/4" (7 cm)

ADSON RETRACTOR



Hinged arm design.

ITEM #	DESCRIPTION
KM52474	4 x 5 blunt prongs, 13" (33 cm)

BECKMAN-WEITLANER RETRACTORS



This modification involves the addition of the Beckman Hinge to Weitlaner Retractors. Pilling® Pattern, satin finish.

ITEM #	DESCRIPTION
165370	3 x 4 sharp prongs, 5-1/2" (14 cm)
165372	3 x 4 sharp prongs, 6-1/2" (16.5 cm)
165374	3 x 4 sharp prongs, 8-1/4" (21 cm)
165380	3 x 4 blunt prongs, 5-1/2" (14 cm)
165382	3 x 4 blunt prongs, 6-1/2" (16.5 cm)
165384	3 x 4 blunt prongs, 8-1/4" (21 cm)

RETRACTORS, SELF-RETAINING

Weitlaner, Gelpi and Henly-Type Retractors

BECKMAN RETRACTOR



488370

Weck® Pattern, bright finish.

ITEM #	DESCRIPTION
488370	4 x 4 sharp prongs, 12-1/2" (32 cm)

BECKMAN RETRACTORS



KM52470

ITEM #	DESCRIPTION
KM52470	4 x 4 sharp prongs, 27 mm, side blade 5/8" (1.5 cm) deep, 12-1/4" (31 cm)
KM52472	4 x 4 blunt prongs, 27 mm, side blade 5/8" (1.5 cm) deep, 12-1/4" (31 cm)

BECKMAN-ADSON LAMINECTOMY RETRACTORS



KM52484

With hinged blades.

ITEM #	DESCRIPTION
KM52484	4 x 4 blunt prongs, 28 x 29 mm, 12-1/4" (31 cm)
KM52486	4 x 4 sharp prongs, 28 x 47 mm, 12-1/4" (31 cm)
KM52488	4 x 4 blunt prongs, 25 x 44 mm, 12-1/4" (31 cm)
KM52490	4 x 4 sharp prongs, 28 x 29 mm, 12-1/4" (31 cm)

RETRACTORS, SELF-RETAINING

Weitlaner, Gelpi and Henly-Type Retractors

BECKMAN-ADSON RETRACTORS

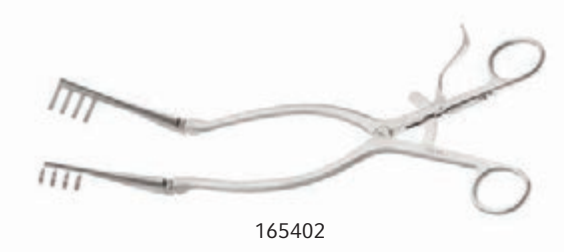

Modification of Beckman having Adson blades.
4 x 4 blunt prongs. Pilling® Pattern, satin finish.

ITEM #	DESCRIPTION
165400	4 x 4 blunt prongs, 1" (2.5 cm) deep blades, 12-1/4" (31 cm)
165402	4 x 4 blunt prongs, 1-1/4" (3 cm) deep blades, 13" (33 cm)

BECKMAN-EATON RETRACTOR



ITEM #	DESCRIPTION
KM52476	7 x 7 sharp prongs, 40 x 48 mm, 12-1/4" (31 cm)

BECKMAN-WEITLANER RETRACTORS



With hinged blades. KMedic® Pattern, satin finish.

ITEM #	DESCRIPTION
KM52542	3 x 4 sharp prongs, 22 mm, 9-1/2" (24 cm)
KM52544	3 x 4 blunt prongs, 22 mm, 9-1/2" (24 cm)

RETRACTORS, SELF-RETAINING

Weitlaner, Gelpi and Henly-Type Retractors

DEBAKEY® GELPI RETRACTOR, SHORT MODEL



ITEM #	DESCRIPTION
165439	Sharp prongs, 5-3/8" (13.5 cm)

GELPI RETRACTORS



Weck® Pattern, bright finish. Sharp prongs.

ITEM #	DESCRIPTION
488390	7-1/4" (18.5 cm)
488395	5-3/8" (13.5 cm)

GELPI STANDARD RETRACTOR

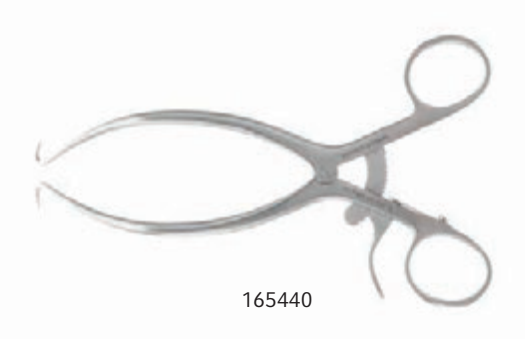

Pilling® Pattern, satin finish.

ITEM #	DESCRIPTION
165440	Standard type (no stops), single sharp prongs, 7" (18 cm)

RETRACTORS, SELF-RETAINING

Weitlaner, Gelpi and Henly-Type Retractors

GELPI RETRACTORS



KMedic® Pattern, satin finish.

ITEM #	DESCRIPTION
KM52776	3-1/2" (9 cm)
KM52778	4-3/8" (11 cm)
KM52768	7-1/4" (18.5 cm)
KM52769	With ball stops, 7" (18 cm)

GELPI-SELETZ RETRACTOR



ITEM #	DESCRIPTION
KM52765	Sharp points, deep blades, 6-1/4" (16 cm)

RETRACTORS, SELF-RETAINING

Weitlaner, Gelpi and Henly-Type Retractors

JOHNSON NEUROMA RETRACTOR



Designed to aid in the removal of interdigital neuroma. Tips overlap in closed position making insertion and removal of retractor easier. Provides excellent visibility of neuroma when retractor is in open position.

ITEM #	DESCRIPTION
KM52782	Sharp, 5" (12.5 cm)

WILTSE-GELPI RETRACTOR



Deep, angled blades, sharp points.

ITEM #	DESCRIPTION
KM52771	Angled shaft, 10-7/8" (27.5 cm)

ORIGINAL HENLY POPLITEAL RETRACTOR



A modification of the Weitlaner retractor with provisions for attachment of a third retractor blade for improved exposure in either the popliteal or carotid positions. Supplied with 3 center blades. The retraction surfaces of the center blades are grooved for soft tissue retraction.

ITEM #	DESCRIPTION
351779	4 x 3 prongs, center blades: 5/8" wide x 3/4" deep (1.5 x 2 cm), 5/8" wide x 1" deep (1.5 x 2.5 cm), 5/8" wide x 1-1/4" deep (1.5 x 3 cm), overall length 6-3/8" (16 cm)



RETRACTORS, SELF-RETAINING

Weitlaner, Gelpi and Henly-Type Retractors

HENLY POPLITEAL RETRACTOR



488350

Weck® Pattern, bright finish.

ITEM #	DESCRIPTION
488350	With 3 detachable center blades: 16 mm wide x 20 mm / 26 mm / 32 mm, 6-3/8" (16 cm)

IMPROVED HENLY RETRACTORS



351679

With interchangeable center blades and side blades.

ITEM #	DESCRIPTION
351679	Henly Retractor with straight arms, side blades slide onto arms
351680	Henly Retractor with arms spread outward. Both are complete with: <ul style="list-style-type: none"> • 1 frame • 3 center blades, 7/8", 1-1/8" and 1-1/4" deep x 5/8" wide, (2, 3 and 3 cm deep x 1.5 cm wide) • 3 pair of side blades with blunt prongs, 1", 2" and 3" deep x 7/8" wide, (2.5, 5 and 7.5 cm deep x 2 cm wide)



351680

RETRACTORS, SELF-RETAINING

Weitlaner, Gelpi and Henly-Type Retractors

IMPROVED HENLY RETRACTOR SIDE BLADES



351676

Shallow, medium and deep interchangeable sliding side blades.

ITEM #	DESCRIPTION
351676	1 pair, 1" x 7/8" (2.5 x 2 cm)
351677	1 pair, 2" x 7/8" (5 x 2 cm)
351678	1 pair, 3" x 7/8" (7.5 x 2 cm)

MAINI SIDE BLADE FOR HENLY RETRACTOR



351661

ITEM #	DESCRIPTION
351661	2-3/4 x 2" (7 X 5 cm), slide on

MAINI RICHARDSON DOUBLE ENDED CENTER BLADE FOR HENLY RETRACTOR



351664

ITEM #	DESCRIPTION
351664	Blade ends are 31 and 40 mm wide

RETRACTORS, SELF-RETAINING

Weitlaner, Gelpi and Henly-Type Retractors

PILLING® MULTIPURPOSE RETRACTORS



A versatile self-retaining Henly type retractor designed for use in the following surgical specialties: peripheral vascular surgery in the carotid, subclavian, femoral, popliteal and tibial regions. Spinal surgery in the cervical and lumbar regions. Orthopedic surgery in shoulder and hip procedures. General surgery for inguinal hernia, appendectomy and many minor procedures.

ITEM #	DESCRIPTION
351675	Pilling® Multipurpose Retractor Set, complete with: 1 frame, 3 center blades in sizes 7/8", 1-1/8" and 1-1/4" deep x 5/8" wide (2, 2.8, and 3.2 cm deep x 1.5 cm wide), 3 pairs of side blades
351666	1 pair side blades, 1-1/8" x 7/8" (3 x 2 cm) for 351675
351667	1 pair side blades, 2-1/8" x 7/8" (5.5 x 2 cm) for 351675
351668	1 pair side blades, 3-1/8" x 7/8" (8 x 2 cm) for 351675
351669	Center blade, 7/8" x 5/8" (2 x 1.5 cm) for 351675
351670	Center blade, 1-1/8" x 5/8" (3 x 1.5 cm) for 351675
351671	Center blade, 1-1/4" x 5/8" (3 x 1.5 cm) for 351675
351672	Center blade, 2" x 5/8" (5 x 1.5 cm) for 351675
351673	Center blade, 2-1/2" x 5/8" (6.5 x 1.5 cm) for 351675

EXTRA LONG CENTER BLADES

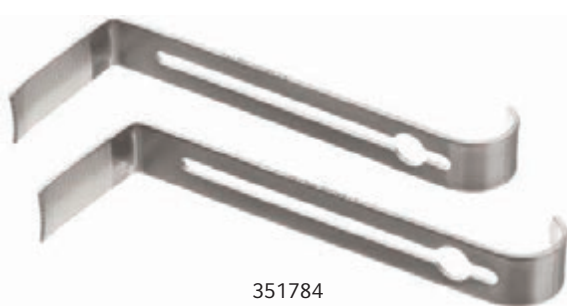

Fits all Henly and Pilling® Multipurpose Retractors.

ITEM #	DESCRIPTION
351784	Two extra-long center blades in sizes 1-1/2" (4 cm) and 1-3/4" (4.5 cm) deep x 5/8" (1.5 cm) wide

RETRACTORS, SELF-RETAINING

Abdominal/Balfour-Type Retractors

BALFOUR RETRACTORS

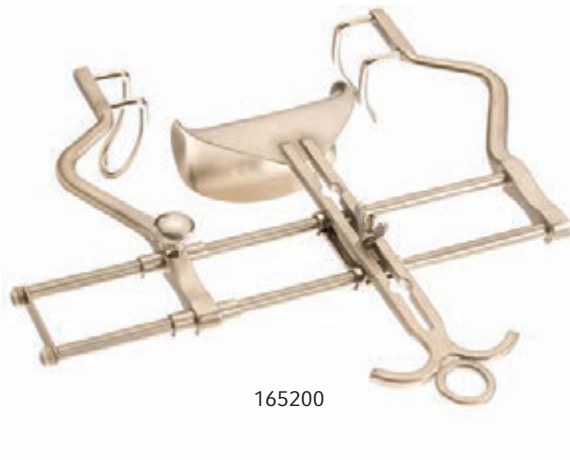

165200

Trigger controlled, positive automatic ratchet retaining design. Free, smooth easy movement of all parts. Large selection of blade designs and sizes. Stainless steel construction.

ITEM #	DESCRIPTION
165200	Wire lateral blades 2" deep (5 cm), center blade 3-5/8" wide x 1-3/4" deep (9 x 4.5 cm), 7" (18 cm) spread
165203	Wire lateral blades 4-3/8" deep (11 cm), center blade 4-3/16" deep x 2-1/2" wide (10.5 x 6.5 cm), 7" (18 cm) spread
165240	Pediatric. Miniature model, arms 3-1/2" long (9 cm), lateral blades 3/4" (2 cm) deep, 4" (10 cm) spread



165240

RETRACTORS, SELF-RETAINING

Abdominal/Balfour-Type Retractors

BALFOUR RETRACTORS PERMANENT SIDE BLADE MODEL



165105

ITEM #	DESCRIPTION
165100	Side blades 2-1/2" (6.5 cm) deep. Center blade 2-3/4" (7 cm) wide x 1-3/4" (4.5 cm) deep, standard size 8" (20.5 cm) opening
165105	Side blades 3-1/2" (9 cm) deep. Center blade 3-1/2" (9 cm) wide x 1-3/4" (4.5 cm) deep, standard size 8" (20.5 cm) opening

IMPROVED BALFOUR RETRACTORS INTERCHANGEABLE SIDE BLADE MODEL



165130

Lateral blades may be easily snapped on and off. Set includes 2 pairs of detachable wire lateral blades 2-1/2" (6.5 cm) and 3-1/2" (9 cm) deep.

ITEM #	DESCRIPTION
165130	Center blade 2-1/2" (6.5 cm) wide, standard size, 8" (20.5 cm) opening
165133	Center blade 3-1/2" (8.8 cm) wide, extra wide 10-1/2" (26.5 cm) opening
165135	Extra solid lateral blades 2-1/2" (6.5 cm) deep, per pair
165137	Extra wire lateral blades, 2-1/2" (6.5 cm) deep, per pair
165138	Extra wire lateral blades, 3-1/2" (9 cm) deep, per pair



165133

RETRACTORS, SELF-RETAINING

Abdominal/Balfour-Type Retractors

TRANSPLANT RECOVERY BALFOUR RETRACTORS



165107

Transplant retractors for the recovery of the abdominal organs. Spiked lateral blades for maximum hold.

ITEM #	DESCRIPTION
165107	Adult, 2 x 2 sharp prongs, blades 2-3/4" (7 cm), overall length of arms 7-7/8" (20 cm), 17" (43 cm) spread

RETRACTORS, SELF-RETAINING

Abdominal/Balfour-Type Retractors

BALFOUR CENTER BLADES



165141



165142



165146



165149

These blades are made for use with the Balfour Retractors 165100 through 165133.

ITEM #	DESCRIPTION
165141	Standard, 3-1/2" wide x 1-1/4" deep (8.8 cm x 3.2 cm)
165142	Standard, 2-3/4" wide x 1-3/4" deep (7 cm x 4.4 cm)
165143	Supra-Pubic, 3-1/2" wide x 2-5/8" deep (8.8 cm x 6.8 cm)
165145	Narrow, 1-5/8" wide x 3-1/2" deep (4.2 cm x 8.8 cm)
165146	Wide, 2-1/2" wide x 2-5/8" deep (6.3 cm x 6.8 cm)
165147	Wide, 2-1/2" wide x 3-1/2" deep (6.3 cm x 8.8 cm)
165149	Horgan malleable 2" wide x 7-3/4" long (5 x 19.5 cm)
165150	Horgan malleable 2-1/2" wide x 8" long (6.5 x 20.5 cm)

YU HOLTGREVE MALLEABLE BLADE



165160

ITEM #	DESCRIPTION
165160	2-1/2" wide x 5-7/8" deep x 9-3/8" long (6.5 x 15 x 24 cm)

RETRACTORS, SELF-RETAINING

Abdominal/Balfour-Type Retractors

BALFOUR FOURTH BLADE ATTACHMENTS



165170

Locks securely to arm of Balfour retractors, holding fourth blade. (Blade not included).

ITEM #	DESCRIPTION
165170	For right arm
165171	For left arm

O'SULLIVAN-O'CONNOR ABDOMINAL RETRACTORS



485450

ITEM #	DESCRIPTION
165300	Adjustable shape ring Two lateral blades, 1" wide x 3" deep (2.5 x 7.5 cm). Set complete with three detachable blades: 2 small, 1-3/4" wide x 3" deep (4.5 x 7.5 cm), and 1 large, 2-3/4" wide
485450	Blades on frame are 73 x 27 mm Three detachable blades: 2 small, 1-3/4" wide x 3-1/8" deep (4.5 x 8 cm), and 1 large, 2-7/8" wide x 4" deep (7 x 10 cm) Spread 12-1/2" (32 cm)

WEXLER BANTAM RETRACTOR



486100

For pediatric and minor surgery use. Set comes complete with frame, 1 center blade and 2 side blades.

ITEM #	DESCRIPTION
486100	Center blade is 1-1/4" deep x 3/4" wide (3 x 2 cm), side blade is 1-1/8" deep x 7/8" wide (3 x 2.5 cm), 3-7/8" (10 cm) spread

RETRACTORS, SELF-RETAINING

Abdominal/Balfour-Type Retractors

WEXLER STANDARD OCTAGON FRAME

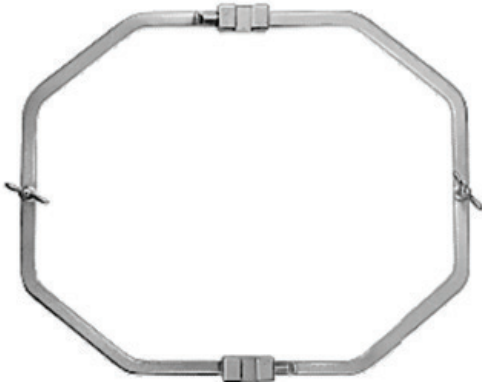

485205

Lateral catches for two blades.

ITEM #	DESCRIPTION
485205	11-5/16" x 9-3/16" (28.5 x 23.5 cm)

UNIVERSAL JOINT FOR WEXLER RETRACTORS



485210

ITEM #	DESCRIPTION
485210	Allows rotation on ball with locking arm for Wexler Retractors

WEXLER DEEVER BLADE



485220

For Wexler Retractors.

ITEM #	DESCRIPTION
485220	2" wide x 4-5/16" deep (5 x 11 cm), 9" (23 cm)



RETRACTORS, SELF-RETAINING

Abdominal/Balfour-Type Retractors

WEXLER DEEP SPREADER



485262

For Wexler Retractors.

ITEM #	DESCRIPTION
485262	4" x 1-7/8" blades (10 x 5 cm), 5-1/4" (13.5 cm), pair of 2

WEXLER EXPANDABLE BLADE



485225

ITEM #	DESCRIPTION
485225	2-3/4" (7 cm) wide blade, expands to 5" (12.5 cm)

RETRACTORS, SELF-RETAINING

Thyroid Retractors

HAMBURGER-BRENNAN-MAHORNER RETRACTOR



485270

Set comes complete with frame and 2 side blades.

ITEM #	DESCRIPTION
485270	7 pointed prongs, 18 x 32 mm, detachable side blades are 5-3/4" (14.5 cm), 33 x 29 mm blade, 4" (10 cm) spread, overall length 9-1/16" (23 cm)

MAHORNER THYROID RETRACTOR

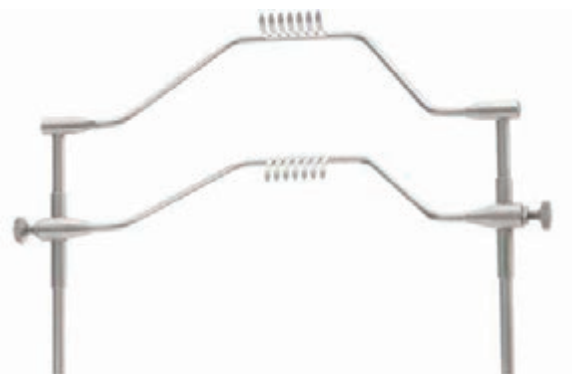

485265

ITEM #	DESCRIPTION
485265	7 pointed prongs, 15 x 32 mm, 4-3/8" (11 cm) spread, overall 9" (23 cm)



RETRACTORS, TABLE-MOUNTED

Circuitract Retractor System



MAXIMUM EXPOSURE SAVES OR TIME.

The familiar, easy-to-use Pilling® Circuitract System provides maximum exposure for optimal visibility. With a comprehensive offering, our retractor blades are available in sizes ranging from pediatric to bariatric. All Circuitract components are more affordable and completely compatible with the Bookwalter® system.

Circuitract Set includes:

- Horizontal Bar, 14-1/2"
- Post Coupling Clamp
- Vertical Post Table Clamp, 12"
- Horizontal Flex Bar
- Non-Tilting Ratchet (2 per set)
- Advanced Tilting Ratchet (6 per set)
- Ribbon Blade, 2 x 6-1/2" (2 per set)
- Ribbon Blade, 1-1/2" x 6"
- Ribbon Blade, 3 x 6-1/2"
- Kelly Blade, 2 x 3" (2 per set)
- Kelly Blade, 2 x 4"
- Kelly Blade, 2 x 5"
- Kelly Blade, 2 x 6"
- Balfour Blade, 3 x 3-1/2"
- Gelpi Blade
- Harrington Blade, 2-1/2 x 5"
- Oval Ring - Medium
- Segmented Oval Ring - Medium

RETRACTORS, TABLE-MOUNTED

Circuitract Retractor System

CIRCUTRACT SET - COMPONENTS

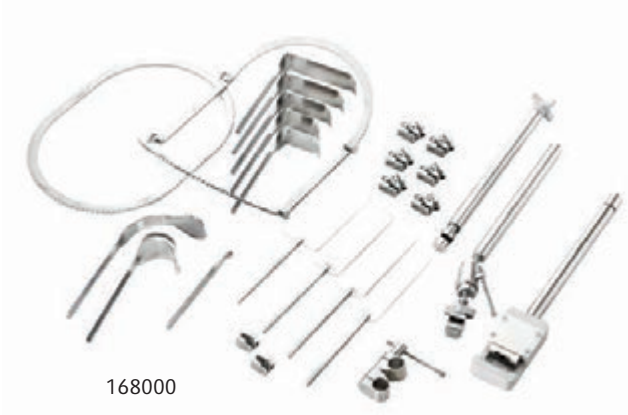

CIRCUTRACT RETRACTOR SYSTEM

ITEM #	QTY/ SET	DESCRIPTION
168000		Circuitract Set - Components included:
168101	1	Horizontal Bar, 14-1/2"
168103	1	Post Coupling Clamp
168104	1	Vertical Post Table Clamp, 12"
168105	1	Horizontal Flex Bar
168110	2	Non-Tilting Ratchet
168111	6	Advanced Tilting Ratchet
168201	2	Ribbon Blade, 2 x 6-1/2"
168202	1	Ribbon Blade, 1-1/2" x 6"
168203	1	Ribbon Blade, 3 x 6-1/2"
168210	2	Kelly Blade, 2 x 3"
168211	1	Kelly Blade, 2 x 4"
168212	1	Kelly Blade, 2 x 5"
168213	1	Kelly Blade, 2 x 6"
168220	1	Balfour Blade, 3 x 3-1/2"
168221	1	Gelpi Blade
168222	1	Harrington Blade, 2-1/2 x 5"
168254	1	Oval Ring - Medium
168257	1	Segmented Oval Ring - Medium

BARIATRIC COMPONENTS

ITEM #	DESCRIPTION
168263	Bariatric Vertical Post, 18-3/8"
168262	Bariatric Segmented Ring - Extra-Large
168205	Bariatric Blade Malleable, 2 x 10"
168206	Bariatric Blade Malleable, 3 x 10"
168207	Bariatric Blade Malleable, 4 x 10"
168208	Bariatric Blade Malleable, 3 x 12"
168209	Bariatric Blade Malleable, 4 x 12"
168223	Bariatric Harrington Blade, 3-1/2 x 10"
168218	Bariatric Kelly Blade, 2 x 8"

ADDITIONAL COMPONENTS

ITEM #	DESCRIPTION
168102	Extension Bar
168214	Kelly Blade, 1 x 1-1/4"
168215	Kelly Blade, 1 x 2-1/2"
168216	Kelly Blade, 2 x 1-1/2"
168217	Kelly Blade, 2 x 2-1/2"
168253	Oval Ring - Small
168255	Oval Ring - Large
168256	Segmented Oval Ring - Small
168258	Segmented Oval Ring - Large
168250	Round Ring - Small, 8-1/2"
168251	Round Ring - Medium, 10-1/2"
168252	Round Ring - Large, 12-1/2"
168259	Ring Straight Segments 4" - Sold in Pairs
168260	Ring Straight Segments 6" - Sold in Pairs
168261	Ring Straight Segments 8" - Sold in Pairs
168156	Segmented Ring Replacement Screw
168232	Rectal Blade, 22 x 2-3/4"
168233	Rectal Blade, 23 x 4"
168204	Ribbon Blade, 2 x 8"
168245	Vaginal Deaver Blade - Extra Small 1 x 3-1/2"
168246	Vaginal Deaver Blade - Small 1 x 4-1/2"
168247	Vaginal Deaver Blade - Medium 1 1/2 x 4-1/2"
168248	Vaginal Deaver Blade - Large 2 x 4-1/2"
168228	Rake Blade 3 Prong
168229	Rake Blade 4 Prong
168230	Rake Blade 6 Prong
168243	Lateral Vaginal Blade, 1 x 3"
168244	Posterior Vaginal Blade, 1 x 4-1/2"
168249	Vaginal Retractor Ring, 8 x 10-1/2"
168196	Malleable Pedi Blade, 3/4 x 3"
168197	Malleable Pedi Blade, 1 x 4"
168198	Malleable Pedi Blade, 1 x 5"
168199	Malleable Pedi Blade, 1-1/2 x 3"
168200	Malleable Pedi Blade, 1-1/2 x 4"
168235	Scoville Hook Blade, 2"
168236	Scoville Hook Blade, 3-1/4"
168225	Meyerding Blade, 2-1/3 x 2/3"
168226	Meyerding Blade, 3-1/3 x 1"
168227	Meyerding Blade, 3-3/4 x 2"

RETRACTORS, TABLE-MOUNTED

Wishbone Retractor System

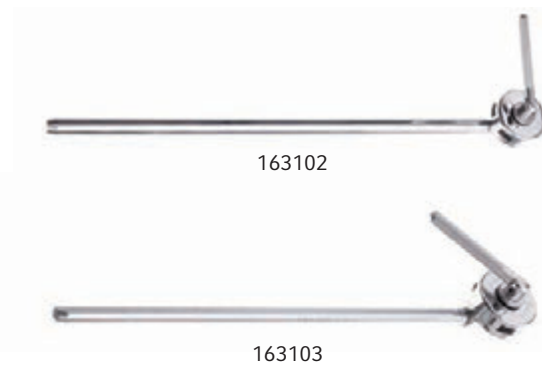

WISHBONE RETRACTOR SYSTEM

Basic system is supplied with a wide assortment of retractor blades for various purposes. Special blade requirements may be ordered economically from your Pilling® Weck® surgical representative. All components are constructed of heat-treated 400 Series stainless steel. There are no plastic washers or small parts.

- A single post table-mounted self-retaining retractor designed for any major abdominal vascular procedures of the aorta, iliacs and their branches.
- Allows use of multiple blades of various configurations, eliminating the need for second or third assistants.
- Non-wavering, non-tiring, self-retaining retraction provides better exposure, speeding the procedure with less postoperative pain.
- Far more versatile than the traditional types of self-retaining retractors. Less restrictive than enclosed ring and frame type retractors.
- Can be easily set up and positioned by the surgeon and one assistant. The rail clamp may be attached to the table rail over the patient drapes.
- Disc clamps on the table upright and crossbar are easily tightened and provide greater force and stability than other systems.
- Closed and open universal clamps that attach the retractor blades to the "wishbone" frame both feature a unique captive design. Clamps are easily cleaned ultrasonically without disassembling them.
- Open distal end of the "split wishbone" allows easier tunneling if grafting is required below the ilio-femoral junction. "split (two piece) wishbone" frame allows simplified handling and assembly and will fit standard sterilizing trays.

RETRACTORS, TABLE-MOUNTED

Wishbone Retractor System

ABDOMINAL VASCULAR RETRACTOR SET WITH SPLIT WISHBONE - COMPONENTS



163109



163200



163201



163203



163211



163213



163400



163401

ITEM #	DESCRIPTION	QTY.
163000	Complete set	1
ITEM #	SET COMPONENTS	SET QTY.
163100	Pilling® Table Clamp	
163102	Upright with Disc Clamp, 20-5/8"	
163103	Crossbar with attached Disc Clamp	
163104	Wishbone-Split Bar, left and right	
163108	Closed Universal Clamp	6
163109	Open Universal Clamp	2
163200	Splanchnic Retractor, 2 x 4-1/4"	
163201	Splanchnic Retractor, 2 x 6-1/4"	
163203	Renal Vein Retractor, 1 x 6"	2
163211	Mayo Retractor, standard, 2-5/8 x 2-1/4"	2
163213	Richardson Retractor, Swivel, 1 x 1-3/4"	
163400	Blade Holder, swivel with handle, 6-1/4"	2
163401	Blade Holder, swivel with knob, 9-1/4"	
163406	Fence Blade, swivel, 4 x 6"	
163420	Mayo Blade, swivel, 2-5/8 x 2-1/4"	
163422	Mayo Blade, wide swivel, 3-1/2 x 2-3/4"	
163424	Deaver Blade, swivel, 2-3/4 x 4-1/2"	
163212	Mayo Retractor, wide, 3-1/2 x 2-3/4"	
163111	Bariatric Crossbar	
163117	Bariatric Side Arm	



163406



163420



163422



163424



163111



163117



RETRACTORS, TABLE-MOUNTED

Wishbone Retractor System

WISHBONE LECHNER-HARRINGTON LIVER BLADE



163436

ITEM #	DESCRIPTION
163436	1-5/8" x 5" x 10" (4 x 12.5 x 25.5 cm)

Miscellaneous Retractors

GOMEZ/POLY-TRACT POLY CLAMPS



166000

The Pilling® Poly-Clamp is a highly versatile operating table rail clamp for use with the Gomez, Poly-Tract Fowler, and other retractor systems, as well as with other equipment to be attached to the operating room table. The Poly-Clamp has been designed to fit the side rail of any currently manufactured U.S. or European operating room table.

ITEM #	DESCRIPTION
166000	Single
166002	Set of four

RETRACTOR FIBER OPTIC "LIGHT BEAM"



163701

This malleable fiber optic light bundle can illuminate the many difficult-to-access surgical sites in the abdomen and pelvis. The captive clamp will attach to many standard table mounted and self-retaining retractors. It can be operated from fiber optic light sources which accept Pilling® Fiber Optic Cables.

ITEM #	DESCRIPTION
163701	

SUCTION TUBES

General

ADSON SUCTION TUBES



See "Scales and Gauges" chart in the beginning of the catalog for French size/mm conversion.

ITEM #	DESCRIPTION
536103	Straight suction with finger valve, 4 mm tip, 8-1/4" (21 cm)

ADSON SUCTION TUBES, CURVED



Curved suction with finger valve. See "Scales and Gauges" chart in the beginning of the catalog for French size/mm conversion.

ITEM #	DESCRIPTION
536100	7 mm, 7-1/4" (18.5 cm)
536104	6 mm, 8-1/4" (21 cm)
536105	5 mm, 6-1/2" (16.5 cm)

FERGUSON-FRAZIER SUCTION TUBES

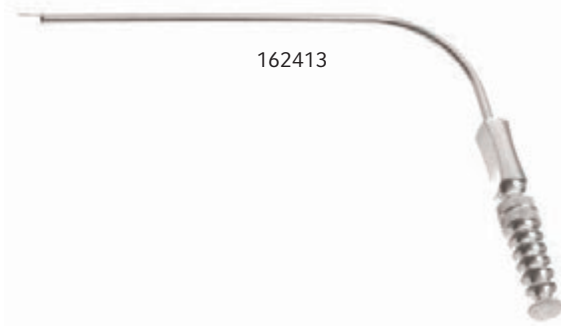

Stainless steel tubes, block-type finger valve, complete with cleaning stylette. Angled. 4-7/8" (12.5 cm). Pilling® Pattern, satin finish.

ITEM #	DESCRIPTION
162410	# 0, 6 Fr. tip
162411	# 1, 7 Fr. tip
162412	# 2, 8 Fr. tip
162413	# 3, 9 Fr. tip
162414	# 4, 10 Fr. tip
162415	# 5, 12 Fr. tip
162416	# 6, 14 Fr. tip
162421	Ferguson Stylet # 0

FRAZIER SUCTION TUBES

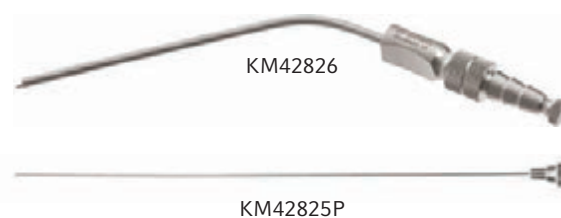

7" (18 cm). 1 Fr. = .33 mm. KMedic® Pattern, satin finish.

ITEM #	DESCRIPTION
KM42823	6 Fr. tip
KM42824	7 Fr. tip
KM42825	8 Fr. tip
KM42826	10 Fr. tip
KM42830	12 Fr. tip
KM42825P	Frazier Stylet 8 Fr.

SUCTION TUBES

General

FRAZIER SUCTION TUBES



KMedic® Pattern, satin finish.

ITEM #	DESCRIPTION
KM42863	7 Fr. tip, 4-1/2" (11.5 cm)
KM42864	9 Fr. tip, 4-1/2" (11.5 cm)
KM42866	11 Fr. tip, 4-1/2" (11.5 cm)
KM42873	7 Fr. tip, 7-1/2" (19 cm)
KM42874	9 Fr. tip, 7-1/2" (19 cm)
KM42876	11 Fr. tip, 7-1/2" (19 cm)

PEDIATRIC POOLE SUCTION TUBE



ITEM #	DESCRIPTION
536107	16 Fr., 6 mm tip, 7-1/2" (19 cm)

POOL ABDOMINAL SUCTION TUBES



Removable inner tube in multi-perforated outer tube.

ITEM #	DESCRIPTION
162210	Large, 30 Fr., straight connector, 9-1/4" (23.5 cm)
162212	Small, 23 Fr., curved connector, 10-1/4" (26 cm)

YANKAUER SUCTION TUBES



ITEM #	DESCRIPTION
162300	Standard adult size, 10 mm diameter. Tip has 2 mm central opening and four 2 mm, side openings. Length 11-1/2" (29 cm)
162301	Tip only for 162300 Yankauer, 1/2" (12.5 mm)



162301

SUCTION TUBES

General

YANKAUER SUCTION TUBE WITH SWITCH VALVE



For use with wall suction. Stopcock-type valve allows reliable "on-off" action. Tube is detachable for cleaning.

ITEM #	DESCRIPTION
162345	11-3/4" (30 cm)

Specialty

BARON SUCTION TUBES



With finger cut-off.

ITEM #	DESCRIPTION
411700	3 Fr. tip
411702	5 Fr. tip
411704	7 Fr. tip

ROSEN SUCTION TUBES

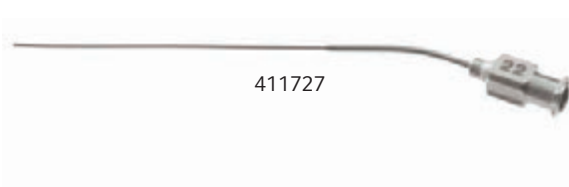

ITEM #	DESCRIPTION
411720	14 Ga. tip, 3-3/4" (9.5 cm)
411724	18 Ga. tip, 3-3/4" (9.5 cm)
411726	20 Ga. tip, 3-3/4" (9.5 cm)
411727	22 Ga. tip, 3-3/4" (9.5 cm)
411728	24 Ga. tip, 3-3/4" (9.5 cm)

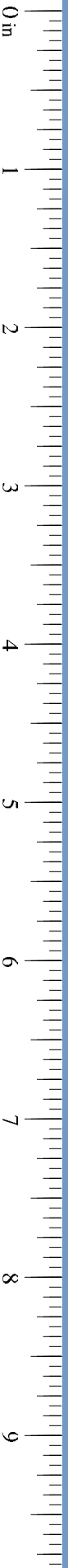

SUCTION TUBES

Specialty

FUKUSHIMA SUCTION TUBES



Teardrop opening allows surgeon to regulate force of suction.

ITEM #	DESCRIPTION
KM42880	4 Fr. tip, 6-1/4" (16 cm)
KM42881	5 Fr. tip, 6-1/4" (16 cm)
KM42882	6 Fr. tip, 6-1/4" (16 cm)
KM42883	7 Fr. tip, 6-1/4" (16 cm)
KM42884	8 Fr. tip, 6-1/4" (16 cm)
KM42885	9 Fr. tip, 6-1/4" (16 cm)
KM42890	4 Fr. tip, 7" (18 cm)
KM42891	5 Fr. tip, 7" (18 cm)
KM42892	6 Fr. tip, 7" (18 cm)
KM42893	7 Fr. tip, 7" (18 cm)
KM42894	8 Fr. tip, 7" (18 cm)
KM42895	9 Fr. tip, 7" (18 cm)
KM42901	4 Fr. tip, 8" (20.5 cm)
KM42902	5 Fr. tip, 8" (20.5 cm)
KM42903	6 Fr. tip, 8" (20.5 cm)
KM42904	7 Fr. tip, 8" (20.5 cm)
KM42905	8 Fr. tip, 8" (20.5 cm)
KM42906	9 Fr. tip, 8" (20.5 cm)

ANDREWS INFANT SUCTION TUBE



6 mm diameter tip, permanently attached.

ITEM #	DESCRIPTION
162310	9-1/4" (23.5 cm)

ANDREWS PYNCHON SUCTION TUBE



ITEM #	DESCRIPTION
536220	Curved, 6 mm tip, 3 mm diameter removable shaft, 9-5/8" (24.5 cm)

SUCTION TUBES

Specialty

COOLEY SUMP SUCTION TUBE



351547

Long, removable perforated outer tube with internal extension provides for fluid removal by sump-drain principle. Entire tube removable from handle for cleaning and rotatable for convenience.

ITEM #	DESCRIPTION
351547	Curved, 9 mm tip, 12-7/8" (32.5 cm)

DEBAKEY® FIBEROPTIC ILLUMINATED SUCTION TUBE



351508

A modification of the DeBakey®-Yankauer Tube but with a special tip to provide for greater volume of aspirated fluids. Large distal central opening is surrounded by circular perforations and slots in the sides.

ITEM #	DESCRIPTION
351508	9.5 mm tip, 11-3/8" (29 cm)

DEBAKEY® SUCTION TUBES



351500

ITEM #	DESCRIPTION
351500	9.5 mm tip, 11-3/8" (29 cm)
351501	Debakey® Suction Tube Tip for 351500, 3/8" (9.5 mm)



351501

SUCTION TUBES

Specialty

DEBAKEY® SUCTION TUBE



351502

Distal opening with four side openings 3 mm long, 4 mm diameter.

ITEM #	DESCRIPTION
351502	3 mm diameter tip, 12-1/4" (31 cm)

DEBAKEY®-ADSON CORONARY SUCTION TUBES

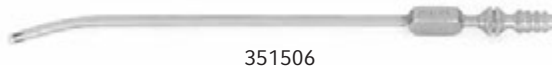

351506

Distal opening with four side openings 3 mm long, 4 mm diameter.

ITEM #	DESCRIPTION
351504	6-1/8" (15.5 cm)
351506	8-1/8" (20.5 cm)

MORSE-ANDREWS SUCTION TUBE



351505

Short length, small 3 mm outside diameter tube, terminating in 6 mm diameter tip which has one distal and four side openings. Handle is ebonized.

ITEM #	DESCRIPTION
351505	10-1/4" (26 cm)

EXTENDED LENGTH/OPEN BARIATRIC

Knife Handles/Suction Tubes

KNIFE HANDLES



175055

ITEM #	DESCRIPTION
175055	#3, 16" (40.5 cm)
175056	#3, 18" (45.5 cm)

YANKAUER SUCTION TUBES



175115

ITEM #	DESCRIPTION
175114	12" (30.5 cm)
175115	14" (35.5 cm)
175116	16" (40.5 cm)
175117	18" (45.5 cm)

POOLE SUCTION TUBES



175086

ITEM #	DESCRIPTION
175083	30 Fr. tip, 12" (30.5 cm)
175084	30 Fr. tip, 16" (40.5 cm)
175085	30 Fr. tip, 18" (45.5 cm)
175086	14" (35.5 cm)

Forceps and Clamps

THUMB TISSUE FORCEPS



175109

ITEM #	DESCRIPTION
175109	1 x 2 teeth, 16" (40.5 cm)
175110	1 x 2 teeth, 18" (45.5 cm)

POTTS SMITH FORCEPS



175087

ITEM #	DESCRIPTION
175087	14" (35.5 cm)
175088	1 x 2 teeth, 14" (35.5 cm)

EXTENDED LENGTH/OPEN BARIATRIC

Forceps and Clamps

RUSSIAN TISSUE FORCEPS



ITEM #	DESCRIPTION
175104	12" (30.5 cm)
175105	14" (35.5 cm)
175106	16" (40.5 cm)

DEBAKEY® TISSUE FORCEPS

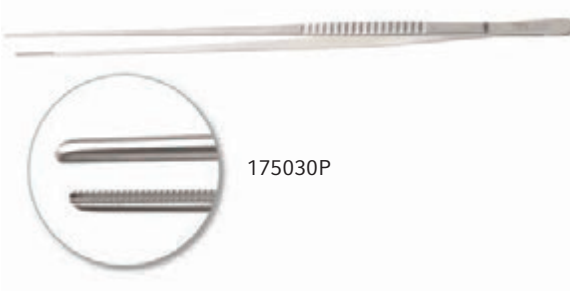

ITEM #	DESCRIPTION
175026	12" (30.5 cm), TC
175027	14" (35.5 cm), 2 mm
175028	16" (40.5 cm), 2 mm
175029	18" (45.5 cm), 2 mm
175030P	14" (35.5 cm), 3 mm
175031	16" (40.5 cm), 3 mm
175032	18" (45.5 cm), 2.5 mm

GERALD DRESSING FORCEPS



ITEM #	DESCRIPTION
175037	12" (30.5 cm)

SINGLEY DRESSING FORCEPS



ITEM #	DESCRIPTION
175107	Serrated, 16" (40.5 cm)
175108	Serrated, 18" (45.5 cm)

FOERSTER SPONGE FORCEPS



ITEM #	DESCRIPTION
175033	Straight, 12" (30.5 cm)
175034	Straight, 14" (35.5 cm)
175035	Straight, 16" (40.5 cm)
175036	Straight, 18" (45.5 cm)

EXTENDED LENGTH/OPEN BARIATRIC

Forceps and Clamps

ALLIS TISSUE FORCEPS

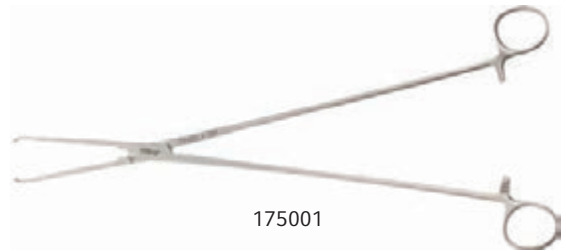

ITEM #	DESCRIPTION
175000	12" (30.5 cm)
175001	14" (35.5 cm)
175002	16" (40.5 cm)
175003	18" (45.5 cm)
175004	X-action, 18" (45.5 cm)

BABCOCK TISSUE FORCEPS



ITEM #	DESCRIPTION
175005	12" (30.5 cm)
175006	14" (35.5 cm)
175007	16" (40.5 cm)
175008	18" (45.5 cm)
175009	X-action, 18" (45.5 cm)

BRIDGE X-ACTION FORCEPS

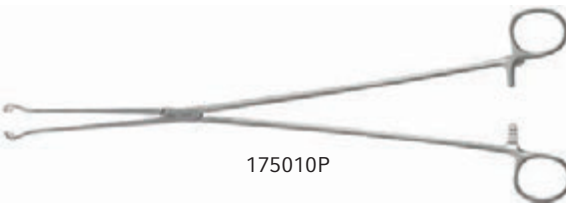

ITEM #	DESCRIPTION
175010P	Curved, 18" (45.5 cm)

CARMALT FORCEPS

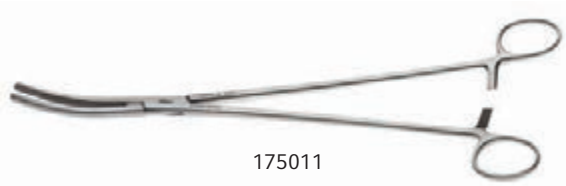

ITEM #	DESCRIPTION
175011	Curved, 12" (30.5 cm)

CLARK ARTERY FORCEPS

ITEM #	DESCRIPTION
175012	Curved, 16" (40.5 cm)
175013	Curved, 18" (45.5 cm)

EXTENDED LENGTH/OPEN BARIATRIC

Forceps and Clamps

COLLIER ANDERSON CLAMPS



ITEM #	DESCRIPTION
175016	10" (25.5 cm)
175017	11" (28 cm)
175018	14" (35.5 cm)
175019	16" (40.5 cm)

KANTROWITZ RIGHT ANGLE FORCEPS

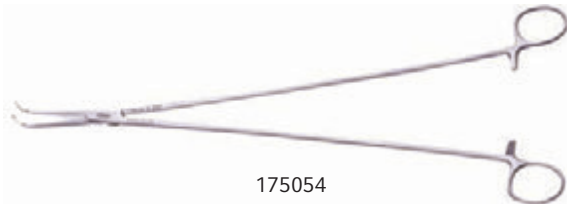

ITEM #	DESCRIPTION
175053	12" (30.5 cm)
175054	14" (35.5 cm)

MIXTER RIGHT ANGLE FORCEPS



ITEM #	DESCRIPTION
175073	16" (40.5 cm)
175074	18" (45.5 cm)

MIXTER RIGHT ANGLE FORCEPS

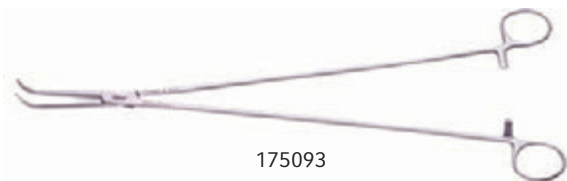

ITEM #	DESCRIPTION
175093	14" (35.5 cm)
175094	18" (45.5 cm)

EXTENDED LENGTH/OPEN BARIATRIC

Forceps and Clamps

RIGHT ANGLE CLAMP

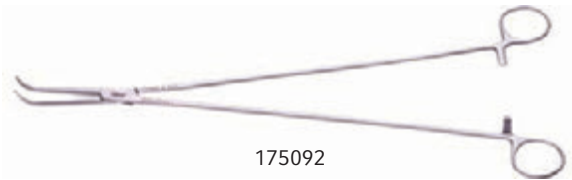

ITEM #	DESCRIPTION
175092	16" (40.5 cm)

RIGHT ANGLE X-ACTION FORCEPS



ITEM #	DESCRIPTION
175095	18" (45.5 cm)

KOCKER X-ACTION FORCEPS



ITEM #	DESCRIPTION
175057	Straight, serrated, 1 x 2 teeth, 18" (45.5 cm)

TONSIL CLAMP

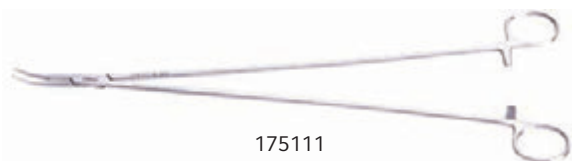

ITEM #	DESCRIPTION
175111	14" (35.5 cm)

TONSIL FORCEPS

ITEM #	DESCRIPTION
175112	Straight, serrated, 16" (40.5 cm)

EXTENDED LENGTH/OPEN BARIATRIC

Forceps and Clamps

ZENKER FORCEPS



ITEM #	DESCRIPTION
175113	Straight, 14" (35.5 cm)

ROCHESTER OCHSNER FORCEPS

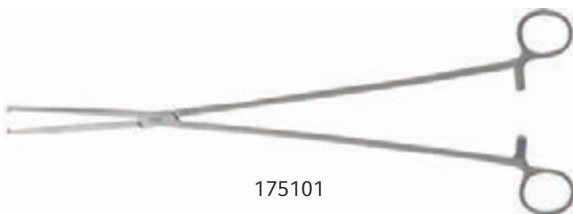

ITEM #	DESCRIPTION
175096	Straight, serrated, 1 x 2 teeth, 18" (45.5 cm)
175100	Straight, 14" (35.5 cm)
175101	Straight, serrated, 1 x 2 teeth, 16" (40.5 cm)

ROCHESTER PEAN FORCEPS



ITEM #	DESCRIPTION
175097	Curved, 14" (35.5 cm)
175098	Curved, 18" (45.5 cm)

ROCHESTER PEAN HEMOSTATIC FORCEPS



ITEM #	DESCRIPTION
175099	16" (40.5 cm)

CLARK HYSTERECTOMY CLAMPS



ITEM #	DESCRIPTION
175014	12" (30.5 cm)
175015P	14" (35.5 cm)

EXTENDED LENGTH/OPEN BARIATRIC

Forceps and Clamps

HEANEY BALLENTINE CLAMPS



ITEM #	DESCRIPTION
175038	Curved, 12" (30.5 cm)
175039	Straight, 12" (30.5 cm)

MASTERSON HYSTERECTOMY FORCEPS



ITEM #	DESCRIPTION
175059	Curved, 10" (25.5 cm)
175060	Straight, 10" (25.5 cm)

ROGERS HYSTERECTOMY FORCEPS



ITEM #	DESCRIPTION
175102	Curved, 10" (25.5 cm)
175103	Straight, 10" (25.5 cm)

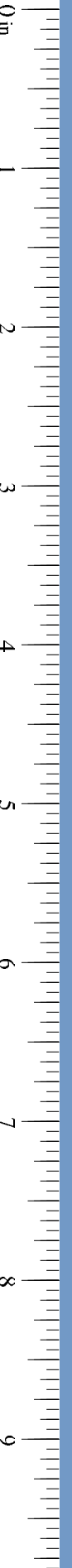



EXTENDED LENGTH/OPEN BARIATRIC

Forceps and Clamps

Z-HYSTERECTOMY FORCEPS

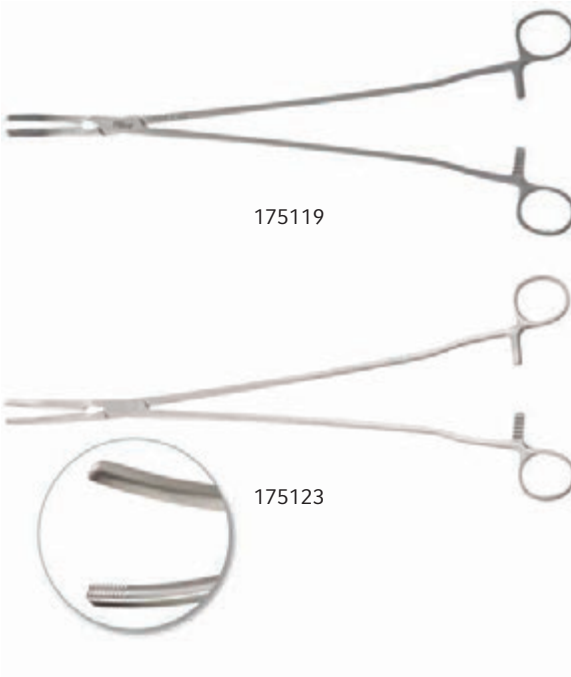

ITEM #	DESCRIPTION
175118	Angled, 12" (30.5 cm)
175119	Angled, 14" (35.5 cm)
175120	Straight, 12" (30.5 cm)
175121	Straight, 14" (35.5 cm)
175122	Slight curved, 12" (30.5 cm)
175123	Slight curved, 14" (35.5 cm)
175124	Full curved, 12" (30.5 cm)
175125	Full curved, 14" (35.5 cm)

Scissors

COOLEY SCISSORS

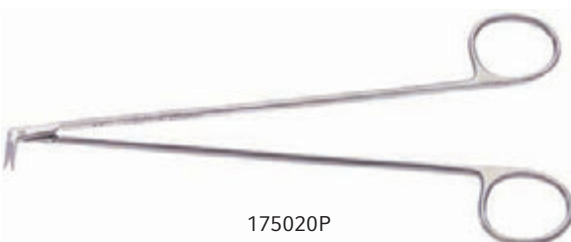

ITEM #	DESCRIPTION
175020P	Curved, 12" (30.5 cm)

EXTENDED LENGTH/OPEN BARIATRIC

Scissors

HYSTERECTOMY SCISSORS



ITEM #	DESCRIPTION
175042	Curved, 10-1/2" (26.5 cm), TC
175043	Curved, 12" (30.5 cm), TC
175045	Medium curved, 10-1/2" (26.5 cm), TC
175046	Medium curved, 12" (30.5 cm), TC
175048	Acutely curved, 10-1/2" (26.5 cm), TC
175049	Acutely curved, 12" (30.5 cm), TC

JORGENSON SCISSORS



ITEM #	DESCRIPTION
175052	Acutely curved, 14" (35.5 cm)

MAYO HARRINGTON SUPER-CUT SCISSORS



ITEM #	DESCRIPTION
175061	Medium curved, 12" (30.5 cm)

MAYO SCISSORS



ITEM #	DESCRIPTION
175067	Medium curved, 14" (35.5 cm), TC
175068	Medium straight, 14" (35.5 cm), TC

EXTENDED LENGTH/OPEN BARIATRIC

Scissors

METZENBAUM SCISSORS



175071

ITEM #	DESCRIPTION
175069	Curved, 12" (30.5 cm), TC
175070	Curved, 14" (35.5 cm), TC
175072	Curved, 16" (40.5 cm), TC
175071	Curved, 18" (45.5 cm), TC

NELSON METZENBAUM SCISSORS



175075

ITEM #	DESCRIPTION
175075	Curved, 16" (40.5 cm)
175076	Curved, 18" (45.5 cm)

NELSON METZENBAUM SUPER-CUT SCISSORS

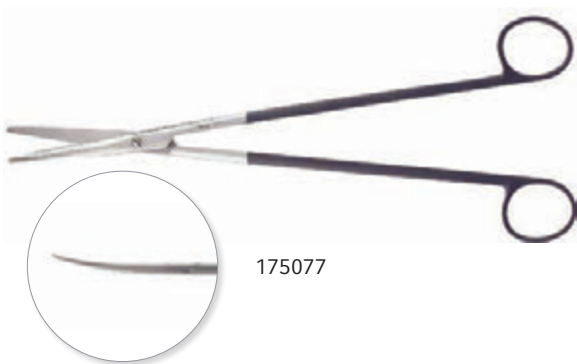

175077

ITEM #	DESCRIPTION
175077	Supercut, curved, 11-3/4" (30 cm)

POTTS TENOTOMY SCISSORS



175090

ITEM #	DESCRIPTION
175089	Curved, 10" (25.5 cm)
175090	Curved, 12" (30.5 cm)
175091	Curved, 14" (35.5 cm)

EXTENDED LENGTH/OPEN BARIATRIC

Needle Holders

CRILE WOOD NEEDLE HOLDERS

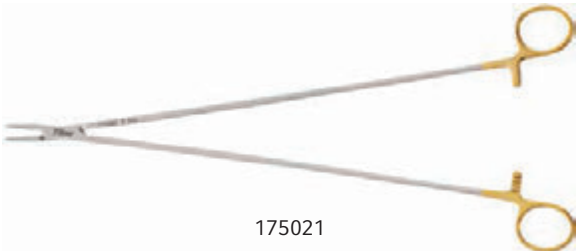

175021

ITEM #	DESCRIPTION
175021	14" (35.5 cm), TC
175022	16" (40.5 cm), TC

HEANEY NEEDLE HOLDERS



175041

ITEM #	DESCRIPTION
175040P	12" (30.5 cm), TC
175041	14" (35.5 cm), TC

MASSON NEEDLE HOLDER



175058

ITEM #	DESCRIPTION
175058	16" (40.5 cm), TC



EXTENDED LENGTH/OPEN BARIATRIC

Needle Holders

MAYO HEGAR NEEDLE HOLDERS

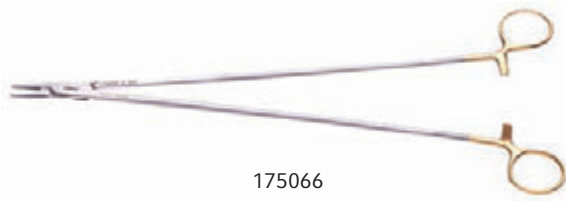

ITEM #	DESCRIPTION
175062	12" (30.5 cm), TC
175066	14" (35.5 cm), TC
175063	18" (45.5 cm), TC

MAYO MASSON NEEDLE HOLDER

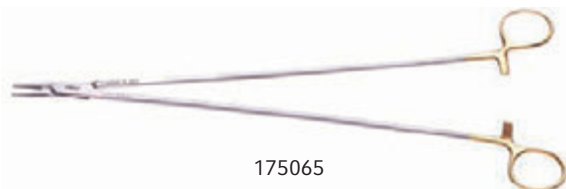

ITEM #	DESCRIPTION
175065	18" (45.5 cm), TC

EXTENDED LENGTH/OPEN BARIATRIC

Needle Holders

NOLAN NEEDLE HOLDERS

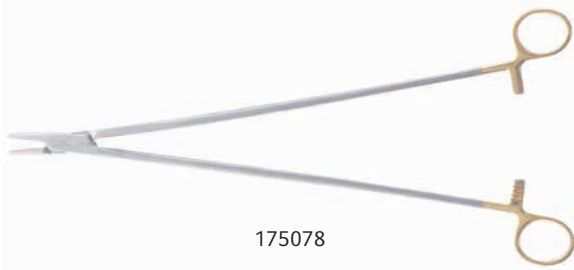

ITEM #	DESCRIPTION
175078	14" (35.5 cm), TC
175079	16" (40.5 cm)
175080	Curved, 16" (40.5 cm), TC
175081	16" (40.5 cm), TC
175082	18" (45.5 cm)

Retractors

CUSHING VEIN RETRACTORS

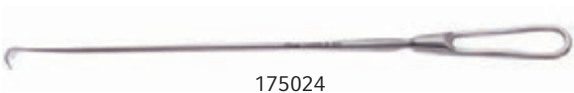

ITEM #	DESCRIPTION
175023	12-1/2" (32 cm)
175024	14" (35.5 cm)
175025P	16" (40.5 cm)



OB/GYN

Forceps and Clamps

BOZEMAN UTERINE DRESSING FORCEPS

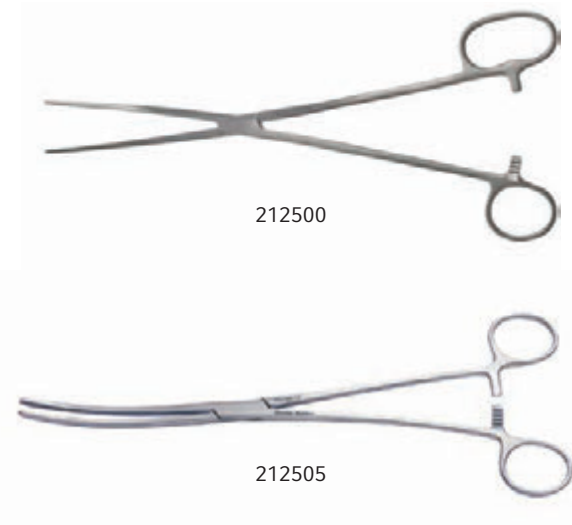

ITEM #	DESCRIPTION
212500	Double-curved, one large ring, 10-1/4" (26 cm)
212505	Standard model, curved, 10-1/4" (26 cm)

DE LEE CERVICAL GRASPING FORCEPS

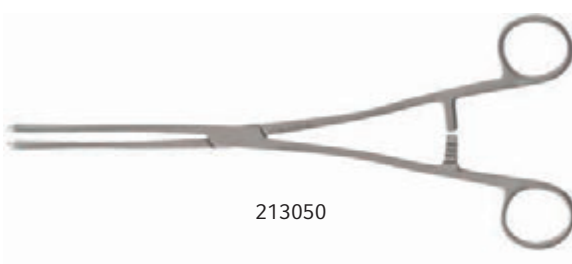

ITEM #	DESCRIPTION
213050	10" (25.5 cm)

KELLY PLACENTA CLAMP

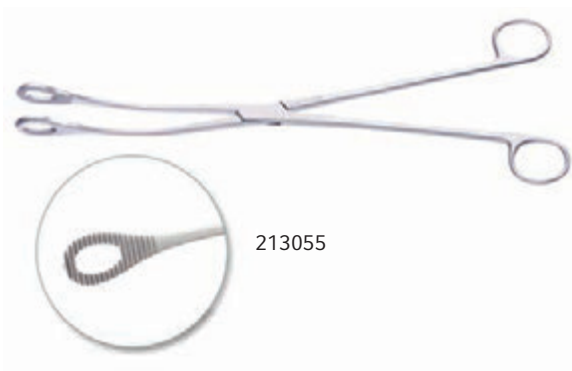

ITEM #	DESCRIPTION
213055	12-5/8" (32 cm)

OB/GYN

Forceps and Clamps

POLK PLACENTA FORCEPS

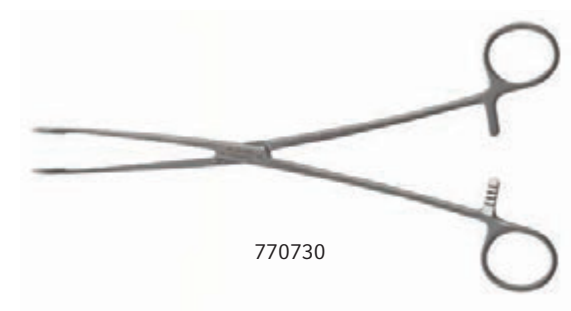

Fenestrated jaw with cross serrations.

ITEM #	DESCRIPTION
770730	Straight, 9-5/8" (24.5 cm)

SOMER UTERINE ELEVATING FORCEPS

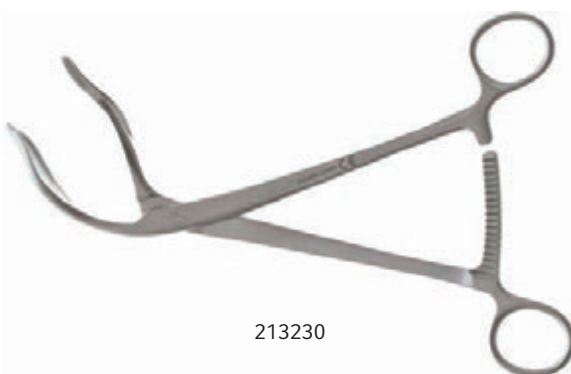

ITEM #	DESCRIPTION
213230	9" (23 cm)

WALLACE CAESAREAN FORCEPS



ITEM #	DESCRIPTION
770405	Serrated, 25 mm jaw, 8" (20.5 cm)





OB/GYN

Forceps and Clamps

PHANEUF UTERINE ARTERY FORCEPS

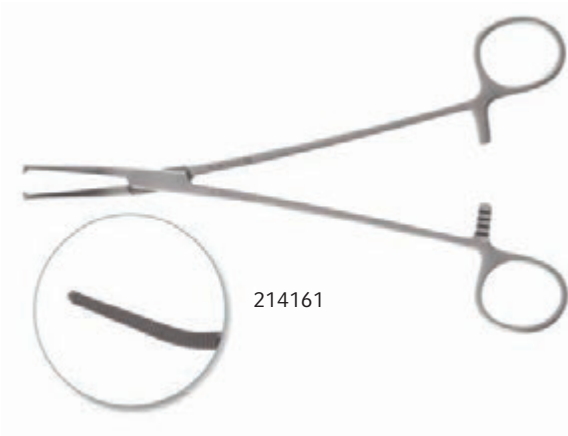

Pilling® Pattern, satin finish.

ITEM #	DESCRIPTION
214161	Short, heavy jaws, 1 x 2 distal teeth, angled, 8-1/4" (21 cm)

PHANEUF UTERINE ARTERY FORCEPS

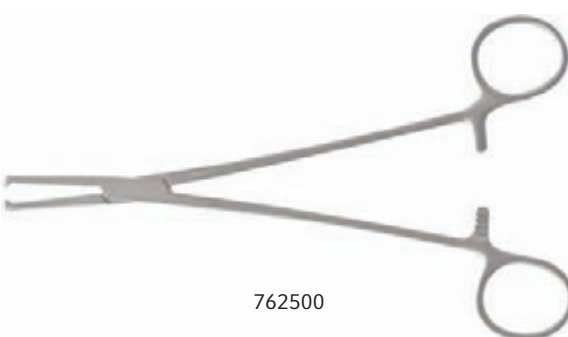

Weck® Pattern, bright finish.

ITEM #	DESCRIPTION
762500	Straight, serrated, 1 x 2 teeth, 4 mm tip, 8-1/4" (21 cm)

BLAND CERVICAL TRACTION FORCEPS



ITEM #	DESCRIPTION
213140	Straight, 10 mm tip, 9-1/4" (23.5 cm)



OB/GYN

Forceps and Clamps

DEBAKEY® HYSTERECTOMY CLAMP

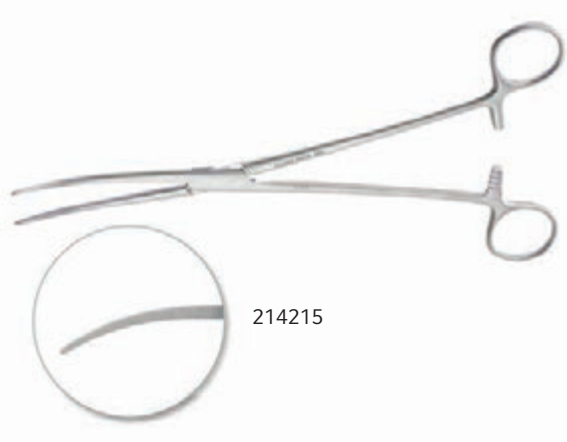

ITEM #	DESCRIPTION
214215	Curved, 9-3/8" (24 cm)

HEANEY HYSTERECTOMY FORCEPS

Double serrated jaws with cross-groove.

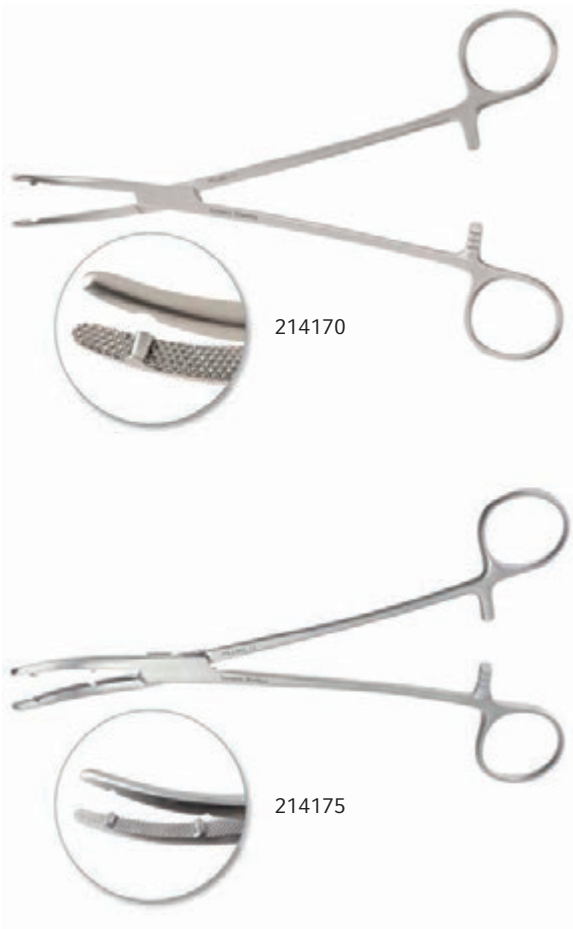

ITEM #	DESCRIPTION
214170	Curved, light jaws, single groove, 8-1/4" (21 cm)
214172	Curved, heavy jaws, single groove, 8-1/4" (21 cm)
214175	Curved, heavy jaws, double groove, 8-1/4" (21 cm)

OB/GYN

Forceps and Clamps

HEANEY-BALLANTINE HYSTERECTOMY CLAMPS



Longitudinally serrated jaws. Single groove.

ITEM #	DESCRIPTION
214180	Straight, 8-1/4" (21 cm)
214182	Curved, 8-1/8" (20.5 cm)

WERTHEIM-CULLEN PEDICLE CLAMP



ITEM #	DESCRIPTION
214230	Angled, longitudinally serrated jaws, 8-5/8" (22 cm)

Biopsy Punches

EPPENDORFER BIOPSY PUNCH



ITEM #	DESCRIPTION
KM65162	Straight, 4 x 8 mm bite, 9" (23 cm)

OB/GYN

Biopsy Punches

KEVORKIAN-YOUNG CERVICAL BIOPSY FORCEPS



ITEM #	DESCRIPTION
213036	10-1/8" (25.5 cm)

SCHUBERT BIOPSY PUNCHES



ITEM #	DESCRIPTION
766520	Angled to side, 5 x 8 mm punch, 9-5/8" (24.5 cm)
766522	Straight, 5 x 8 mm punch, 11" (28 cm)

SCHUBERT BIOPSY PUNCHES



ITEM #	DESCRIPTION
KM65115	Straight, 8-1/2" (21.5 cm)
KM65118	Angled, 10-1/2" (26.5 cm)





OB/GYN

Biopsy Punches

THOMAS-GAYLOR CERVICAL BIOPSY FORCEPS



ITEM #	DESCRIPTION
213011	Curved shanks, 9-1/4" (23.5 cm)

213011

THOMAS-GAYLOR BIOPSY PUNCH



ITEM #	DESCRIPTION
KM65084	Interfitted jaw, 9-1/2" (24 cm)

KM65084

TISCHLER BIOPSY PUNCHES



ITEM #	DESCRIPTION
KM65188	Straight, 3 x 5 mm, 8" (20.5 cm)
KM65186	Straight, 3 x 7 mm, 9" (23 cm)
KM65204	Shaft only, 3 x 7 mm bite
KM65205	Pistol grip handle only for Tischler punch

KM65186

OB/GYN

Biopsy Punches

WITTNER BIOPSY FORCEPS



752526

8 x 6 mm toothed basket jaw, 8-7/8" (22.5 cm) stem.

ITEM #	DESCRIPTION
752526	Straight, 11-1/2" (29 cm)

Circumcision Clamps

GOMCO® CIRCUMCISION CLAMPS



742110

ITEM #	DESCRIPTION
742100	Extra small, 11 mm
742102	Newborn, 13 mm
742104	Infant, 15 mm
742106	Child, 16 mm
742108	Youth, 21 mm
742110	Adult, 26 mm

MOGEN CIRCUMCISION CLAMP



KM64227

ITEM #	DESCRIPTION
KM64227	2-7/8" (7.5 cm)

OB/GYN

Delivery Forceps

DE LEE OBSTETRICAL FORCEPS



214595

ITEM #	DESCRIPTION
214595	12" (30.5 cm)
KM67498	Short model, fenestrated blades, 12" (30.5 cm)
KM67500	Long model, fenestrated blades, 14" (35.5 cm)

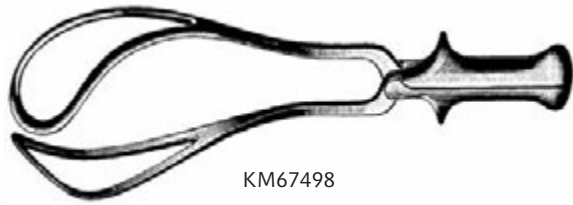

KM67498

ELLIOT OBSTETRICAL FORCEPS



KM67509

ITEM #	DESCRIPTION
KM67509	Short model, fenestrated blades, 12-1/2" (32 cm)
KM67511	Long model, fenestrated blades, 15" (38 cm)

MCCLEAN OBSTETRICAL FORCEPS



KM67516

ITEM #	DESCRIPTION
KM67516	Solid blades, short shanks, 14" (35.5 cm)

OB/GYN

Delivery Forceps

MCLEAN-TUCKER-LUIKART OBSTETRICAL FORCEPS



214605

ITEM #	DESCRIPTION
214605	15-1/2" (39.5 cm)

SIMPSON OBSTETRICAL FORCEPS



214555

ITEM #	DESCRIPTION
214550	14" (35.5 cm)
214555	12" (30.5 cm)

SIMPSON-LUIKART OBSTETRICAL FORCEPS



214570

ITEM #	DESCRIPTION
214570	Fenestrated, smooth, 14" (35.5 cm)
KM67526	Solid blades, 14" (35.5 cm)

Scissors

BUSCH UMBILICAL SCISSORS



KM67294

ITEM #	DESCRIPTION
KM67294	Curved sideways, 6-1/2" (16.5 cm)





OB/GYN

Scissors

UMBILICAL SCISSORS



ITEM #	DESCRIPTION
214090	4-1/8" (10.5 cm)
KM67292	Straight, 4-3/8" (11 cm)

BRAUN EPISIOTOMY SCISSORS



ITEM #	DESCRIPTION
214081	Wide lower blade, angled to side, 8-3/4" (22 cm)

Probes, Sounds and Dilators

EMMETT UTERINE PROBE

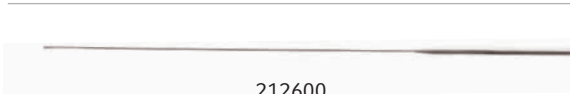

ITEM #	DESCRIPTION
212600	Stainless steel, 11" (28 cm)

OB/GYN

Probes, Sounds and Dilators

SIMPSON UTERINE SOUND



212605

ITEM #	DESCRIPTION
212605	4 mm, graduated in inches, silver plated, 12-3/4" (32.5 cm)

SIMS UTERINE SOUNDS



212612

ITEM #	DESCRIPTION
212610	4 mm, non-graduated, silver plated, 12-3/4" (32.5 cm)
212612	4 mm, graduated in cm, 12-3/4" (32.5 cm)

HANK UTERINE DILATORS



212666

Pilling® Pattern, satin finish. Double-ended. 11 sizes. 9-10 Fr. to 29-30 Fr. Length 10-3/4" (27.5 cm). Single dilator only on sizes 9-10 Fr. to 29-30 Fr. Single units.

ITEM #	DESCRIPTION
212659	Hank Uterine Dilators, set of 6, sizes 11-12 Fr. to 21-22 Fr. (3.66 to 7.33 mm)
212661	9-10 Fr. (3 x 3.3 mm)
212662	11-12 Fr. (3.6 x 4 mm)
212663	13-14 Fr. (4.3 x 4.7 mm)
212664	15-16 Fr. (5 x 5.3 mm)
212665	17-18 Fr. (5.7 x 6 mm)
212666	19-20 Fr. (6.3 x 6.7 mm)
212667	21-22 Fr. (7 x 7.3 mm)
212668	23-24 Fr. (7.7 x 8 mm)
212669	25-26 Fr. (8.3 x 8.7 mm)
212670	27-28 Fr. (9 x 9.3 mm)
212671	29-30 Fr. (9.3 x 10 mm)

HANK UTERINE DILATORS



752382

Weck® Pattern, bright finish. Double-ended. End lengths 2-1/2" (6.5 cm). Length 10-3/8" (26.5 cm).

ITEM #	DESCRIPTION
752380	9/10 American (4.5 x 5 mm)
752381	11/12 American (5.5 x 6 mm)
752382	13/14 American (6.5 x 7 mm)
752383	15/16 American (7.5 x 8 mm)
752384	17/18 American (8.5 x 9 mm)
752385	19/20 American (9.5 x 10 mm)

OB/GYN

Probes, Sounds and Dilators

HEGAR UTERINE DILATORS



212673

Pilling® Pattern, satin finish. Double-ended, 7-7/8" (20 cm).

ITEM #	DESCRIPTION
212673	Set of 8, sizes 3 mm to 18 mm
212675	Size 3-4 mm
212676	Size 5-6 mm
212677	Size 7-8 mm
212678	Size 9-10 mm
212679	Size 11-12 mm
212680	Size 13-14 mm
212681	Size 15-16 mm
212682	Size 17-18 mm



212678

HEGAR UTERINE DILATORS



752354

Weck® Pattern, bright finish. Double-ended, hollow, 7-7/8" (20 cm).

ITEM #	DESCRIPTION
752338	Size 1/2 mm
752347	Size 19/20 mm
752348	Size 21/22 mm
752349	Size 23/24 mm
752351	Size 25/26 mm
752354	Complete set in case

OB/GYN

Probes, Sounds and Dilators

PRATT UTERINE DILATORS



212647

Pilling® Pattern, satin finish. Double-ended, 11-5/8" (29.5 cm). Stainless steel.

ITEM #	DESCRIPTION
212647	Set of 8 in canvas case, sizes 13-15 Fr. to 41-43 Fr.

PRATT UTERINE DILATORS



752394

Weck® Pattern, bright finish. Double-ended, 11-5/8" (29.5 cm).

ITEM #	DESCRIPTION
752390	Size 13-15 Fr.
752391	Size 17-19 Fr.
752392	Size 21-23 Fr.
752393	Size 25-27 Fr.
752394	Size 29-31 Fr.
752395	Size 33-35 Fr.
752396	Size 37-39 Fr.
752397	Size 41-43 Fr.

Curettes

HEANEY BIOPSY CURETTE



212905

ITEM #	DESCRIPTION
212905	9-3/4" (25 cm)



OB/GYN

Curettes

KEVORKIAN-YOUNGE BIOPSY CURETTE

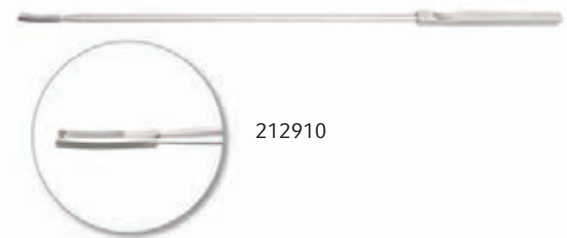

Pilling® Pattern.

ITEM #	DESCRIPTION
212910	12-1/8" (31 cm)

KEVORKIAN-YOUNGE CURETTES



Sharp tip.

ITEM #	DESCRIPTION
KM64796	Without basket, 12" (30.5 cm)
KM64802	With basket, 12" (30.5 cm)

NOVAK BIOPSY CURETTE



ITEM #	DESCRIPTION
212930	Diameter 1/4" (6.5 mm), 9-1/4" (23.5 cm)

OB/GYN

Curettes

RANDALL SUCTION BIOPSY CURETTE

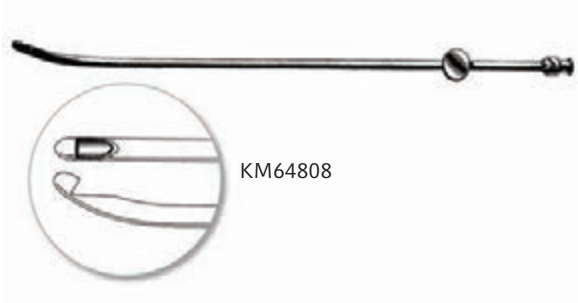

ITEM #	DESCRIPTION
KM64808	Sharp, curved, 4 mm diameter, 9-3/4" (25 cm)

SIMS UTERINE CURETTES



Sharp blades. Malleable shafts.

ITEM #	DESCRIPTION
212749	Size 0, 10-7/8" (27.5 cm)
212750	Size 1, 11-1/4" (28.5 cm)
212751	Size 2, 11-1/4" (28.5 cm)
212752	Size 3, 11-3/8" (29 cm)
212753	Size 4, 11-1/2" (29 cm)
212754	Size 5, 11-1/2" (29 cm)
212755	Size 6, 11-5/8" (29.5 cm)



OB/GYN

Tenaculums and Vulsellums

ADAIR TENACULUM

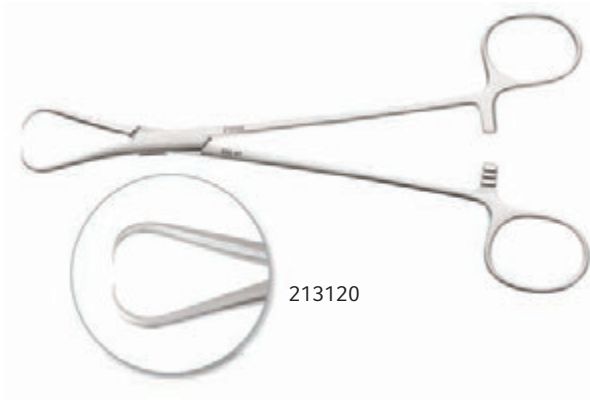

ITEM #	DESCRIPTION
213120	6-7/8" (17.5 cm)

BARRETT TENACULUM



ITEM #	DESCRIPTION
213110	7-1/4" (18.5 cm)

BRAUN TENACULUM



ITEM #	DESCRIPTION
213100	9-5/8" (24.5 cm)

OB/GYN

Tenaculums and Vulsellums

DUPLAY TENACULUM



213085

ITEM #	DESCRIPTION
213085	9-7/8" (25 cm)

HULKA TENACULUM AND PROBE



754125

ITEM #	DESCRIPTION
754125	Single tooth, probe 4-3/4" (12 cm) w/ 3.6 mm tip, 11-1/8" (28.5 cm)

JARCHO TENACULUM



213065

ITEM #	DESCRIPTION
213065	8" (20.5 cm)

SCHROEDER TENACULUM



213080

ITEM #	DESCRIPTION
213080	9-7/8" (25 cm)



OB/GYN

Tenaculums and Vulsellums

STAUDE TENACULUM



ITEM #	DESCRIPTION
213090	5-3/8" (13.5 cm)

STAUDE-MOORE TENACULUM

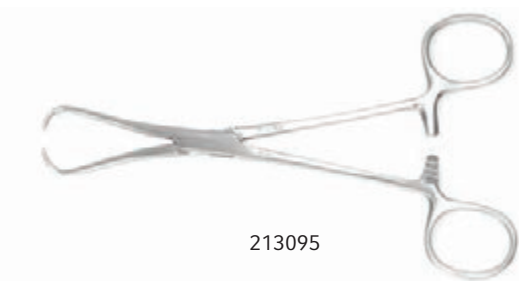

ITEM #	DESCRIPTION
213095	6-3/8" (16 cm)

WYLIE UTERINE TENACULUM

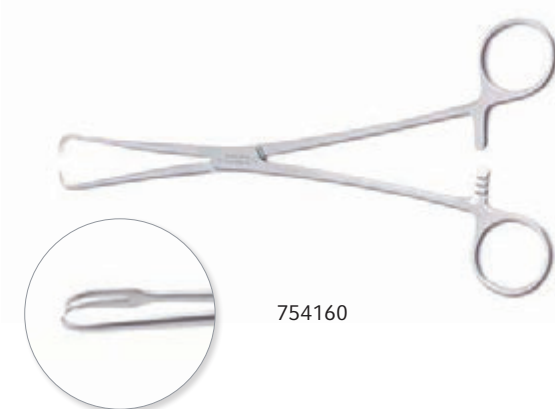

ITEM #	DESCRIPTION
754160	1 x 2 teeth, 9-1/2" (24 cm)

OB/GYN

Tenaculums and Vulsellums

HENROTIN VULSELLUM



213150

ITEM #	DESCRIPTION
213150	8-1/4" (21 cm)

JACOB'S VULSELLUM FORCEPS



213155

ITEM #	DESCRIPTION
213155	Straight, 2 x 2 teeth, 8-1/4" (21 cm)
213157	Curved sideways, serrated, 2 x 2 teeth, 8-1/4" (21 cm)

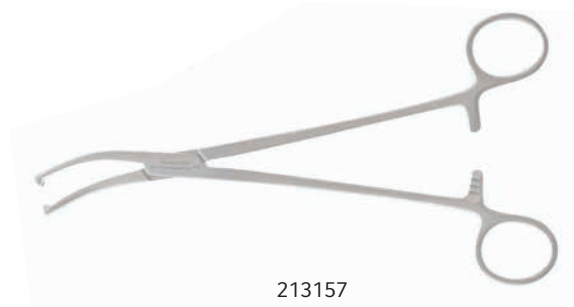

213157

KELLY VULSELLUM



213160

ITEM #	DESCRIPTION
213160	Curved sideways, 9-1/2" (24 cm)

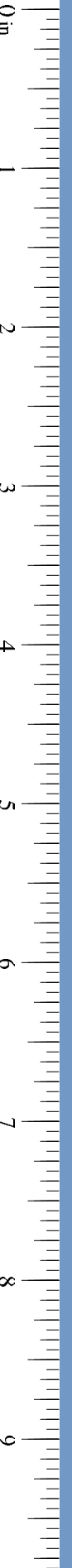

OB/GYN

Tenaculums and Vulsellums

M.G.H. VULSELLUM



ITEM #	DESCRIPTION
213175	3 x 3 teeth, 6-1/8" (15.5 cm)

SCHROEDER VULSELLUM



ITEM #	DESCRIPTION
213180	Straight, 9-7/8" (25 cm)

TEALE UTERINE VULSELLUM



ITEM #	DESCRIPTION
754370	Curved sideways, 3 x 4 teeth, 9-1/4" (23.5 cm)

OB/GYN

Specula

GRAVES VAGINAL SPECULA



ITEM #	DESCRIPTION
212000	Small, 7/8" (2 cm) blade
212001	Medium, 1-3/8" (3.5 cm) blade
212002	Large, 1-1/2" (4 cm) blade
212005	Medium, right open-sided vaginal specula



OB/GYN

Specula

PEDERSON VAGINAL SPECULA



212011

Narrow, straight side blades.

ITEM #	DESCRIPTION
212010	Small, 3-1/4" x 1/2" (8.5 x 1.5 cm)
212011	Medium, 3-1/4" x 1" (8.5 x 2.5 cm)
212012	Large, 4-3/4" x 1" (12 x 2.5 cm) blades

SLENDER PEDERSON SPECULUM



KM64288

ITEM #	DESCRIPTION
KM64288	Narrow blades

KOGAN ENDOCERVICAL SPECULUM



KM64830

ITEM #	DESCRIPTION
KM64830	With gauge and set screw, 9-1/2" (24 cm)

OB/GYN

Specula

AUVARD WEIGHTED VAGINAL SPECULA



ITEM #	DESCRIPTION
212195	3 lbs., 3" (7.5 cm)
212196	2-1/2 lbs., 3-3/8" (8.5 cm)
212197	3 lbs., 4" (10 cm)

GARRIGUE WEIGHTED VAGINAL SPECULUM



ITEM #	DESCRIPTION
212185	Cut-out handle allows drainage. Blade 1-5/8" x 3-1/8" (4 x 8 cm), weight 2 lbs., chrome plated

HENROTIN WEIGHTED VAGINAL SPECULUM



ITEM #	DESCRIPTION
212187	Blade 1-1/2" x 3-1/2" (3.8 x 9 cm), weight 3 lbs, chrome plated





OB/GYN

Retractors

DE LEE UNIVERSAL RETRACTOR



ITEM #	DESCRIPTION
212350	3" x 2-1/8" (7.5 x 5.5 cm) blade, 9-1/2" (24 cm)

EASTMAN VAGINAL RETRACTORS

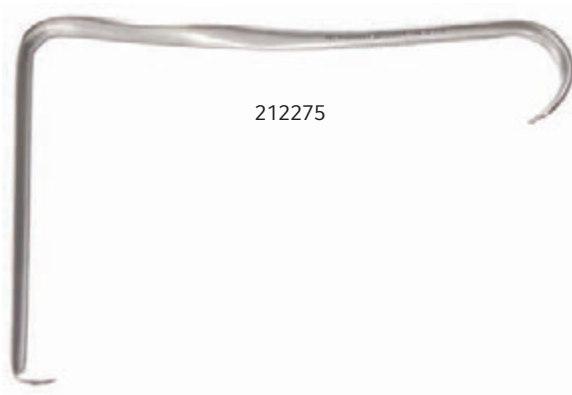

ITEM #	DESCRIPTION
212271	1-3/8" x 3-1/4" (3.5 x 8.5 cm)
212275	1-3/8" x 3-7/8" (3.5 x 10 cm)

HEANEY-SIMON VAGINAL RETRACTOR



ITEM #	DESCRIPTION
212305	1-1/8" x 4-3/4" (2.5 x 12 cm), blade length 11" (28 cm)

OB/GYN

Retractors

JACKSON VAGINAL RETRACTORS



212264

ITEM #	DESCRIPTION
212263	1-9/16" x 3-1/4" (4 x 8.5 cm)
212264	1-9/16" x 3-19/32" (4 x 9 cm)
212265	1-19/32" x 4" (4 x 10 cm)

PRYOR-PEAN RETRACTOR



212295

ITEM #	DESCRIPTION
212295	1" x 4-1/2" (2.5 x 11.5 cm), blade length 10-3/8" (26.5 cm)

SIMS VAGINAL RETRACTORS



212228

Double-ended.

ITEM #	DESCRIPTION
212225	7/8" x 2-5/8" (2 x 6.5 cm) and 1" x 3-1/8" (2.5 x 8 cm)
212226	1" x 2-1/2" (2.5 x 6.5 cm) and 1-1/4" x 3" (3 x 7.5 cm)
212227	1" x 3-1/4" (2.5 x 8.5 cm) and 1-3/16" x 3-1/2" (3 x 9 cm)
212228	1-1/4" x 3" (3 x 7.5 cm) and 1-3/8" x 3-1/4" (3.5 x 8.5 cm)
212229	1-3/16" x 3-1/4" (3 x 8.5 cm) and 1-7/16" x 4" (3.5 x 10 cm)

OB/GYN

Retractors

SIMS VAGINAL RETRACTORS



212241

Single-ended.

ITEM #	DESCRIPTION
212241	1-1/8" x 3-5/8" (3 x 9 cm)
212242	1-1/2" x 3-1/2" (4 x 9 cm)

Laser Instruments

BELLINA LASER RULERS

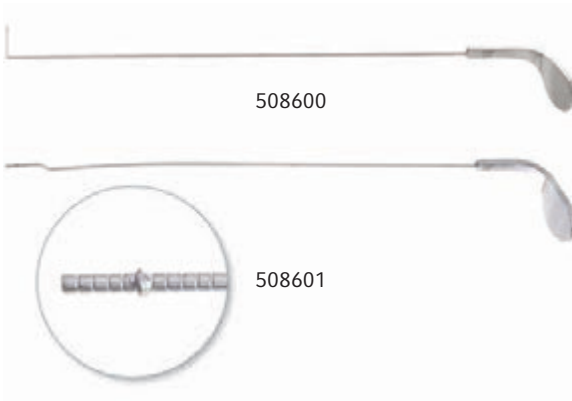

508600

508601

For determining depth and length of tissue for ablation purposes.

ITEM #	DESCRIPTION
508600	Lateral ruler, graduated in millimeters up to 15 mm
508601	Straight ruler, graduated in millimeters with a ridge indicating the 5 mm mark

CERVICAL LASER HOOKS

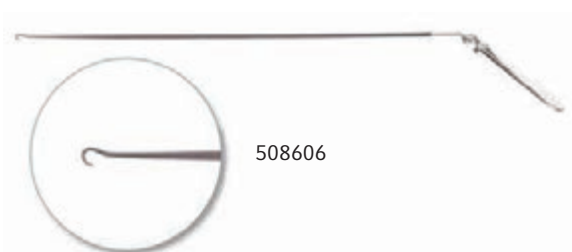

508606

Ebonized for use with laser surgery.

ITEM #	DESCRIPTION
508605	Small, 2 mm hook, 6-1/2" (16.5 cm) working length, overall 9-1/2" (24 cm)
508606	Large, 4 mm hook, 7" (18 cm) working length, overall 9-7/8" (25 cm)

OB/GYN

Laser Instruments

LASER MIRROR

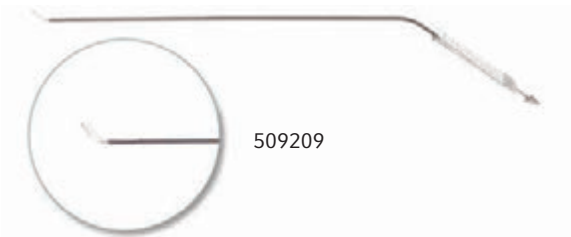

Highly polished stainless steel front surface mirror. Suction to draw smoke and steam.

ITEM #	DESCRIPTION
509209	6 mm diameter, working length 8-1/4" (21 cm)

MILAN-LONDON VACUUM TUBE



Ebonized for use with laser surgery. Clips onto a standard metal Graves speculum for evacuation of smoke and plume.

ITEM #	DESCRIPTION
508602	4-7/8" (12.5 cm)

OSSOFF MICRO SUCTION TUBE EBONIZED



Ebonized for use with laser surgery.

ITEM #	DESCRIPTION
509204	7 Fr., working length 7-7/8" (20 cm)



OB/GYN

Laser Instruments

PILLING® LASER SPECULA



Inner blades are matte finished to help reduce reflection of the laser beam. External blades are polished stainless steel for ease of insertion. One smoke evacuation tube on the upper blade for rapid removal of steam and smoke from the ablated tissue. Available in three sizes.

ITEM #	DESCRIPTION
508610	Small
508612	Medium
508614	Large

SCHROEDER TENACULUM

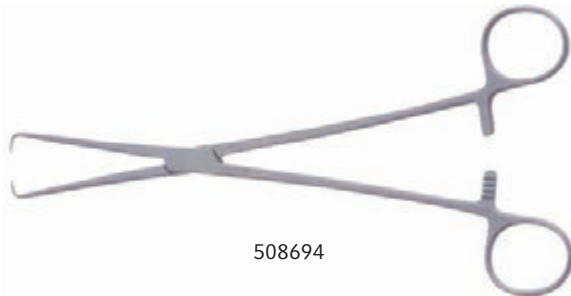

Ebonized for use with laser surgery.

ITEM #	DESCRIPTION
508694	10" (25.5 cm)

THOMS-ALLIS VULSELLUM FORCEPS



Ebonized for use with laser surgery.

ITEM #	DESCRIPTION
508696	Straight, 6 x 7 Teeth, 8" (20.5 cm)

OB/GYN

Miscellaneous



BETHEA SHEET HOLDERS



214770

ITEM #	DESCRIPTION
214770	1" (2.5 cm) wide, 5" (12.5 cm) diameter

EMMETT UTERINE TENACULUM HOOKS



KM65490

9" (23 cm).

ITEM #	DESCRIPTION
KM65490	#1, narrow, curved
KM65492	#2, acutely angled
KM65494	#3, slightly angled
KM65496	#4, wide, curved
KM65498	#5, double angled

IOWA TRUMPET NEEDLE GUIDE



884227

For paracervical anesthesia.

ITEM #	DESCRIPTION
884227	Ball tip 7 mm, 5-1/2" (14 cm)



UROLOGY

Forceps and Clamps

HERRICK KIDNEY CLAMP



ITEM #	DESCRIPTION
746550	Angled, 41 mm jaw with longitudinal serrations, 9" (23 cm)

RANDALL KIDNEY STONE GRASPING FORCEPS



ITEM #	DESCRIPTION
172650	#1, 1/4" curved, 9-1/4" (23.5 cm)
172655	#2, 1/2" curved, 8-1/4" (21 cm)
172660	#3, 3/4" curved, 7-3/4" (19.5 cm)
172665	#4, Full Curved, 7-3/8" (18.5 cm)

UROLOGY

Forceps and Clamps

MAYO VESSEL CLAMP

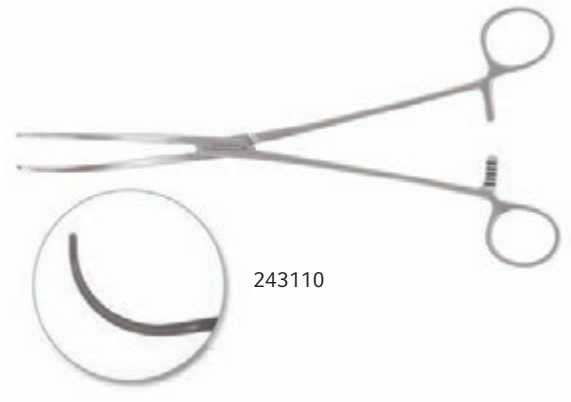

ITEM #	DESCRIPTION
243110	Curved, 1-1/2" (4 cm) tip length, 10" (25.5 cm)

MCDUGAL™ PROSTATECTOMY CLAMPS

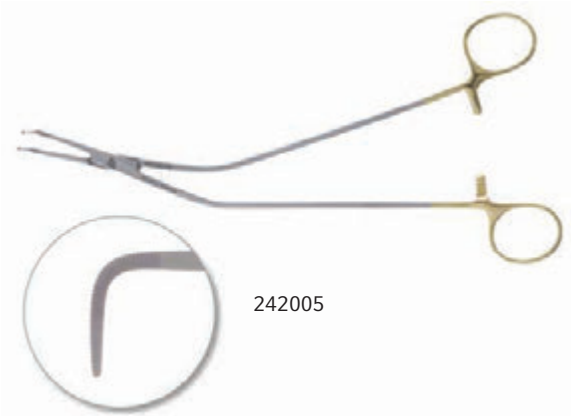

Secures the dorsal vein complex during radical retropubic prostatectomy. Useful for other deep retropubic or deep pelvic work when approached from the abdomen. Allows easy access in operative site obstructed by the pubis or other structures.

ITEM #	DESCRIPTION
242005	Angled left, 1" (2.5 cm) tip length, 9-7/8" (25 cm)
242006	Angled right, 1" (2.5 cm) tip length, 9-7/8" (25 cm)



UROLOGY

Forceps and Clamps

VASECTOMY CLAMP

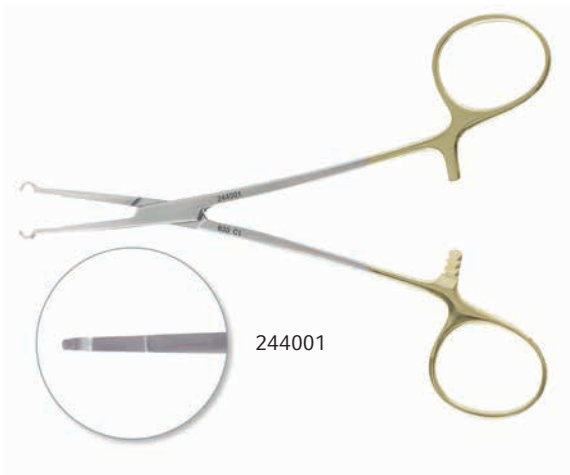

ITEM #	DESCRIPTION
244001	No scalpel ring clamp, 3.6 mm ring I.D., 5-1/2" (14 cm)

VASECTOMY FORCEPS



ITEM #	DESCRIPTION
244000	No scalpel hemostat, 19 Ga. tip, sharp, 5-1/8" (13 cm)



UROLOGY

Forceps and Clamps

ZIPSER PENIS CLAMP

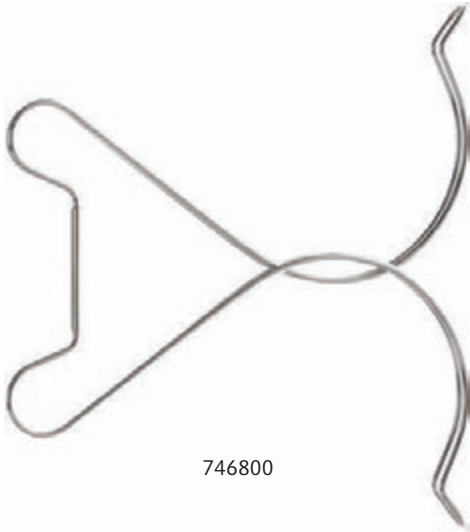

ITEM #	DESCRIPTION
746800	3-3/8" (8.5 cm)

Dilators, Sounds and Needles

DITTEL URETHRAL SOUNDS



KM64014

11-1/2" (29 cm). 1 Fr. = 0.33 mm.

ITEM #	DESCRIPTION
KM64006	Set of 14 in case
KM64008	8 Fr., 11-1/2" (29 cm)
KM64010	10 Fr., 11-1/2" (29 cm)
KM64012	12 Fr., 11-1/2" (29 cm)
KM64014	14 Fr., 11-1/2" (29 cm)
KM64016	16 Fr., 11-1/2" (29 cm)
KM64018	18 Fr., 11-1/2" (29 cm)
KM64020	20 Fr., 11-1/2" (29 cm)
KM64022	22 Fr., 11-1/2" (29 cm)
KM64024	24 Fr., 11-1/2" (29 cm)
KM64026	26 Fr., 11-1/2" (29 cm)
KM64028	28 Fr., 11-1/2" (29 cm)
KM64030	30 Fr., 11-1/2" (29 cm)
KM64032	32 Fr., 11-1/2" (29 cm)
KM64034	34 Fr., 11-1/2" (29 cm)

UROLOGY

Dilators, Sounds and Needles

VAN BUREN URETHRAL DILATORS



10-7/8" (27.5 cm), even sizes, 8 Fr. to 32 Fr.

ITEM #	DESCRIPTION
241108	8 Fr.
241110	10 Fr.
241112	12 Fr.
241114	14 Fr.
241116	16 Fr.
241118	18 Fr.
241120	20 Fr.
241122	22 Fr.
241124	24 Fr.
241126	26 Fr.
241128	28 Fr.
241130	30 Fr.
241132	32 Fr.

LITVAK PEREYRA LIGATURE NEEDLE

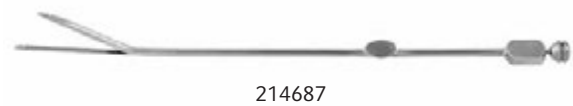

ITEM #	DESCRIPTION
214687	9-7/8" (25 cm)

STAMEY NEEDLES

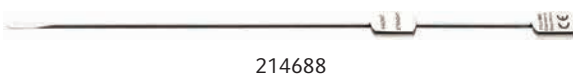

Used in conjunction with the treatment of urinary incontinence in the female.

ITEM #	DESCRIPTION
214688	Straight, 9-3/4" (25 cm)
214689	Angled 15 degrees, 9-3/4" (25 cm)
214691	Angled 30 degrees, 9-3/4" (25 cm)



UROLOGY

Catheter Guides

FEMALE CATHETER SILVERS



ITEM #	DESCRIPTION
740165	14 Fr., 5-7/8" (15 cm)
740166	16 Fr., 5-7/8" (15 cm)

GUYON CATHETER GUIDE



ITEM #	DESCRIPTION
746797	9 Fr., 13-1/4" (33.5 cm)

VAN BUREN CATHETER GUIDE



ITEM #	DESCRIPTION
746798	9 Fr., 13-3/4" (35 cm)

Retractors

LOWSLEY PROSTATIC RETRACTORS

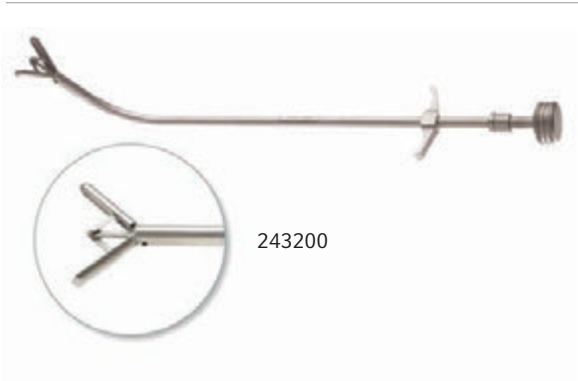

ITEM #	DESCRIPTION
243200	Curved, 9-1/2" (24 cm)
243201	Straight, 12-7/8" (32.5 cm)

RECTAL

Forceps and Clamps

BARRON HEMORRHOIDAL ALLIGATOR SEIZING FORCEPS



ITEM #	DESCRIPTION
202970	5 x 6 teeth, 11-3/4" (30 cm)

BUIE PILE CLAMP

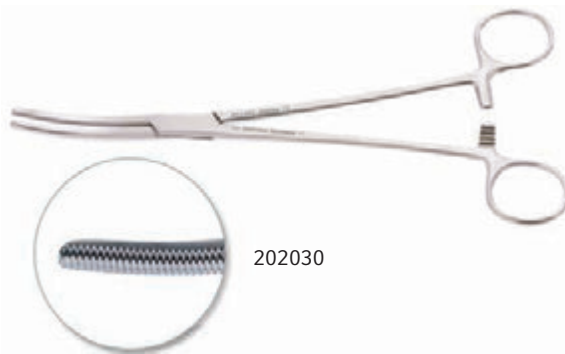

Angiotribe jaws.

ITEM #	DESCRIPTION
202030	Curved, serrated, 5/8" (16 mm) tip length, 8-7/8" (22.5 cm)

FERGUSON ANGIOTRIBE FORCEPS



ITEM #	DESCRIPTION
KM36816	Straight, 6-1/2" (16.5 cm)
KM36818	Curved, 6-1/2" (16.5 cm)
KM36826	Straight, 7-1/2" (19 cm)
KM36828	Curved, 7-1/2" (19 cm)

RECTAL

Forceps and Clamps

MCGIVNEY FORCEPS



KM63503

ITEM #	DESCRIPTION
KM63503	Angled shanks, 7-1/2" (19 cm)

PRATT "T" FORCEPS



477115

Concave, T-shaped jaws, with serrations.

ITEM #	DESCRIPTION
477115	6" (15 cm)

RECTAL BIOPSY FORCEPS



203142

ITEM #	DESCRIPTION
203142	Oval, basket punch type. 13.5 x 4 mm jaw, 14-1/2" (37 cm)





RECTAL

Forceps and Clamps

ROTATING RECTAL BIOPSY FORCEPS

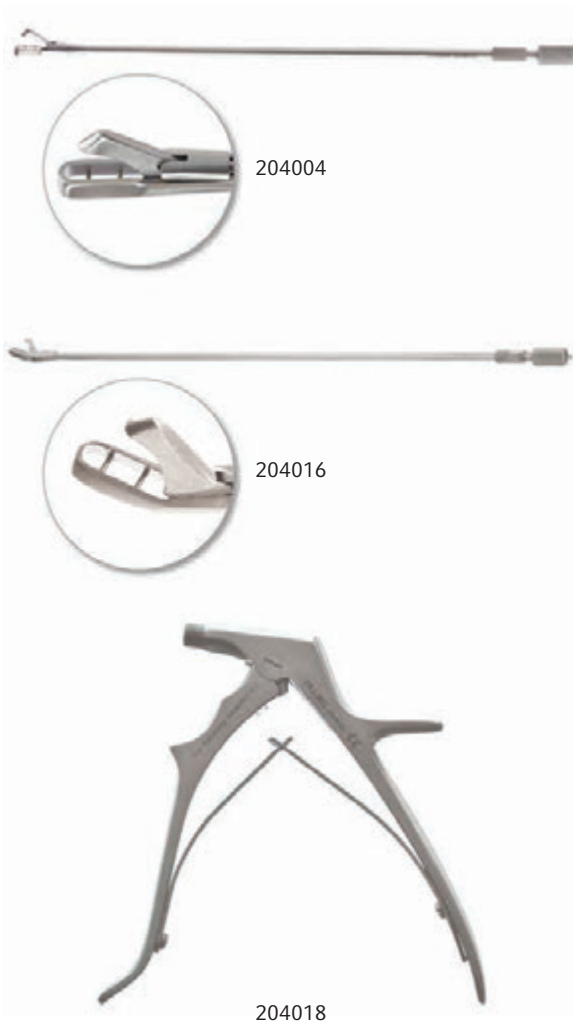

Positive, universal handle. Curved upper jaw and serrated lower jaw give firm grasp and clean cut of tissue. Stems are rotatable full 360 degrees. Stainless steel.

ITEM #	DESCRIPTION
204004	10" (25.5 cm) stem only. Straight jaw.
204016	13-7/8" (35 cm) stem only. Angular jaw.
204018	Handle only.

RECTAL

Retractors and Specula

HILL FERGUSON RECTAL RETRACTORS



ITEM #	DESCRIPTION
730295	Blade 2-3/8" x 1" (6 x 2.5 cm), 8-1/2" (21.5 cm)
730296	Blade 2-3/4" x 1-1/8" (7 x 3 cm), 9-1/2" (24 cm)

SAWYER RECTAL RETRACTORS



ITEM #	DESCRIPTION
202150	Small, blades 2-1/2" x 7/8" (6.5 x 2 cm), 10-5/8" (27 cm)
202151	Medium, blades 3" x 1-1/8" (7.5 x 3 cm), 11" (28 cm)

SMITH RECTAL RETRACTOR



ITEM #	DESCRIPTION
202140	Blade 2-13/16" (7 cm), 8-7/8" (22.5 cm) spread



RECTAL

Retractors and Specula

BODENHAMMER RECTAL SPECULUM



KM63300

ITEM #	DESCRIPTION
KM63300	Set screw, solid blades, 6" (15 cm)

BRINKERHOFF RECTAL SPECULA



KM63354

ITEM #	DESCRIPTION
KM63354	Small
KM63352	Medium
KM63350	Large



RECTAL

Retractors and Specula

FANSLER OPERATING SPECULUM



202105

ITEM #	DESCRIPTION
202105	Slotted tube 2-3/8" (6 cm) long, 1-1/4" (3 cm)

FANSLER-IVES RECTAL SPECULA



KM63319

ITEM #	DESCRIPTION
KM63318	Chrome speculum with obturator
KM63319	Rubber obturator only



RECTAL

Retractors and Specula

PRATT RECTAL SPECULA



202060

ITEM #	DESCRIPTION
202060	Large, blades 3-3/8" (8.5 cm) long, 1" (2.5 cm) diameter
202062	Small, blades 3-1/2" (9 cm) long, 3/4" (2 cm) diameter

SIMS RECTAL SPECULUM



202067

ITEM #	DESCRIPTION
202067	Fenestrated blades 3-1/2" (9 cm) long, 3/4" (2 cm) diameter

RECTAL

Retractors and Specula

HIRSCHMAN ANOSCOPES



ITEM #	DESCRIPTION
202095	Small, 5/8" (16 mm) tip diameter, 2-1/2" (6.5 cm)
202096	Medium, 3/4" (19 mm) tip diameter, 2-3/4" (7 cm)
202097	Large, 7/8" (22 mm) tip diameter, 2-3/4" (7 cm)

Miscellaneous

BARR CRYPT HOOK



ITEM #	DESCRIPTION
202623	Double-ended, 10-1/8" (25.5 cm)

MARTIN RECTAL HOOK



ITEM #	DESCRIPTION
732101	Hook 9 x 2 mm, 7" (18 cm)





RECTAL

Miscellaneous

PRATT CRYPT HOOK

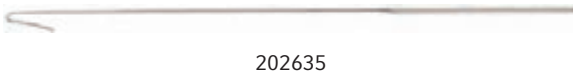

ITEM #	DESCRIPTION
202635	Small hook, 8-7/8" (22.5 cm)

STEWART RECTAL HOOK



ITEM #	DESCRIPTION
202630	7/8" (22 mm) hook, 8-7/8" (22.5 cm)

BUIE SUCTION TUBES

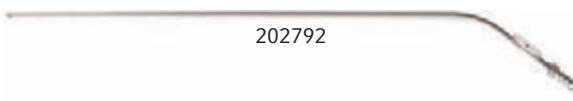

Distal and side openings.

ITEM #	DESCRIPTION
202792	Thumb valve control model, 15 Fr. diameter, 17" (43 cm)

LARRY PROBE AND GROOVE DIRECTOR



ITEM #	DESCRIPTION
202600	5-7/8" (15 cm)

MISCELLANEOUS GENERAL

Probes, Cannulae and Dilators

WILLIAMS LACRIMAL PROBES



166490

5-1/8" (13 cm).

ITEM #	DESCRIPTION
166480	Size 1-2
166485	Size 3-4
166490	Size 5-6
166495	Size 7-8

BOWMAN LACRIMAL PROBES



426096

Sterling silver, 4-7/8" (12.5 cm).

ITEM #	DESCRIPTION
426090	Size 0000-000
426092	Size 00-0
426094	Size 1-2
426096	Size 3-4
426098	Size 5-6
427002	Size 7-8

DOUBLE-ENDED PROBES



166573

Stainless steel.

ITEM #	DESCRIPTION
166571	5-1/8" (13 cm)
166573	6-1/8" (15.5 cm)

GROOVED DIRECTOR AND TONGUE TIES



166611

Plain end, stainless steel.

ITEM #	DESCRIPTION
166610	4-1/2" (11.5 cm)
166611	5-1/8" (13 cm)
166612	5-3/4" (14.5 cm)
166613	6-1/4" (16 cm)

GROOVED DIRECTORS



166632

Probe point, stainless steel.

ITEM #	DESCRIPTION
166632	5-1/2" (14 cm)
166633	6-1/4" (16 cm)

MISCELLANEOUS GENERAL

Probes, Cannulae and Dilators

PROBES WITH PROXIMAL EYE

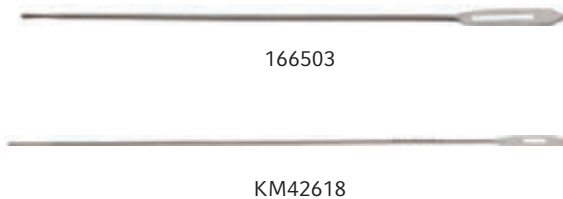

Malleable, stainless steel.

ITEM #	DESCRIPTION
166500	4-1/2" (11.5 cm)
166501	5-1/8" (13 cm)
166502	5-3/4" (14.5 cm)
166503	5-7/8" (15 cm)
166504	7-1/8" (18 cm)
166505	7-7/8" (20 cm)
166507	9-7/8" (25 cm)
KM42618	10" (25.5 cm)

PROBES WITH PROXIMAL EYE

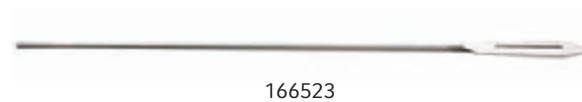

Sterling silver.

ITEM #	DESCRIPTION
166520	4-1/2" (11.5 cm)
166521	5-1/8" (13 cm)
166522	5-3/4" (14.5 cm)
166523	5-7/8" (15 cm)
166527	9-7/8" (25 cm)

PATTERSON TROCAR AND CANNULA



Stainless steel trocar tip with chrome plated handle allows for easy catheter insertion.

ITEM #	DESCRIPTION
534201	Size 1, for 14 Fr. catheter, 7-3/4" (19.5 cm)
534202	Size 2, for 20 Fr. catheter, 8" (20.5 cm)
534203	Size 3, for 26 Fr. catheter, 8" (20.5 cm)

534203

MISCELLANEOUS GENERAL

Probes, Cannulae and Dilators

BAKES COMMON DUCT DILATORS SET

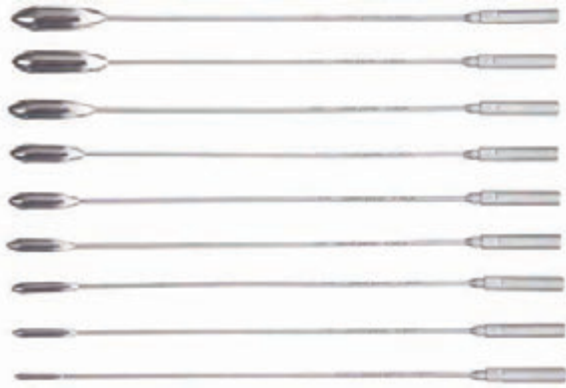

172700

ITEM #	DESCRIPTION
172700	Malleable stainless steel shafts. 9 tip sizes, 3 to 11 mm. Overall length 8-1/2" (21.5 cm). Set of 9 in plastic case.

Measuring Devices

RULERS



KM39694

Flexible, graduated in inches and millimeters.

ITEM #	DESCRIPTION
KM39692	6" (15 cm)
KM39694	8" (20.5 cm)
KM39698	12" (30.5 cm)
KM39700	20" (51 cm)

CENTIMETER SUBTRACTION RULER



504075

For accurate calculation, by subtraction, of the depth to which a scope has been inserted.

ITEM #	DESCRIPTION
504075	30 cm

KUNTSCHER X-RAY SCALE



KM48299

Ruler for X-rays.

ITEM #	DESCRIPTION
KM48299	Graduated in millimeters, 50 cm length (19-5/8")

MISCELLANEOUS GENERAL

Measuring Devices

MEASURING TAPE



KM48313

ITEM #	DESCRIPTION
KM48313	Linen, graduated in inches and centimeters up to 150 cm

POLK FINGER GONIOMETER



KM48310

Graduated in centimeters and inches.

ITEM #	DESCRIPTION
KM48310	6" (15 cm)

ANGLE FINDER



KM48247

ITEM #	DESCRIPTION
KM48247	4-1/8" (10.5 cm)

MISCELLANEOUS GENERAL

Measuring Devices

CASTROVIEJO CALIPERS



KM53042



428630

ITEM #	DESCRIPTION
KM53042	Graduated to 40 mm, 6-1/2" (16.5 cm)
428630	Straight, 0-20 mm scale, 3-3/8" (8.5 cm)

BONE COMPASS



KM48302

ITEM #	DESCRIPTION
KM48302	8" (20.5 cm)

NEURO-CALIPER



KM48315

Inside measuring faces are extra-long (60 mm) for neurosurgery.

ITEM #	DESCRIPTION
KM48315	Graduated in inches and millimeters up to 5-3/4" (14.5 cm), inside and outside measuring, faces and depth bar, 9" (23 cm)

MISCELLANEOUS GENERAL

Measuring Devices

TOWNLEY FEMUR CALIPER



ITEM #	DESCRIPTION
KM48314	Takes inside and outside measurements up to 4" (10 cm)

Dermal Instruments

FOX CURETTES



Round, 5-1/2" (14 cm).

ITEM #	DESCRIPTION
KM29495	1 mm
KM29496	2 mm
KM29497	3 mm
KM29498	4 mm
KM29499	5 mm
KM29500	6 mm

GREG COMDONE EXTRACTOR



ITEM #	DESCRIPTION
KM29606	One fenestrated cup and lancet blade with cap, 5" (12.5 cm)

MISCELLANEOUS GENERAL

Dermal Instruments

KEYES DERMAL SKIN PUNCHES



KM29513

Straight, sharp ring. 4" (10 cm).

ITEM #	DESCRIPTION
KM29511	2 mm
KM29512	3 mm
KM29513	4 mm
KM29514	5 mm
KM29515	6 mm
KM29517	7 mm

KMEDIC® COMDONE EXTRACTOR (WALTON)



KM29604

ITEM #	DESCRIPTION
KM29604	One fenestrated cup and curved lancet with cap

PIFFARD CURETTES



KM29505

Oval, 5-1/2" (14 cm).

ITEM #	DESCRIPTION
KM29503	#1 small
KM29505	#2 medium
KM29507	#3 large

SAALFELD COMDONE EXTRACTOR



KM29566

ITEM #	DESCRIPTION
KM29566	Extra-fine, with lancet and one fenestrated cup, 4-1/2" (11.5 cm)

MISCELLANEOUS GENERAL

Dermal Instruments

SCHAMBERG COMDONE EXTRACTORS



KM29582

3-3/4" (9.5 cm).

ITEM #	DESCRIPTION
KM29580	Standard, crimped loops
KM29582	Extra-fine, crimped loops
KM29584	Square loops

UNNA COMDONE EXTRACTOR



KM29592

ITEM #	DESCRIPTION
KM29592	Fenestrated spoon ends, 5-3/4" (14.5 cm)

Ligature Carriers

DESCHAMPS LIGATURE CARRIERS



152255

ITEM #	DESCRIPTION
152255	Blunt point, left curved, 8-1/8" (20.5 cm)
152256	Blunt point, right curved, 8-1/8" (20.5 cm)

MICRO CLIPS AND APPLIERS

Temporary Vessel Clips

KLEINERT-KUTZ MICRO VESSEL CLIPS



065105

ITEM #	DESCRIPTION
065100	Straight blade, 1 x 3 mm, 0.34" (8.5 mm)
065105	Straight blade, 1 x 5 mm, 0.40" (10 mm)

KLEINERT-KUTZ MICRO VESSEL CLIPS



065145

ITEM #	DESCRIPTION
065125	Angled blade, 1 x 6 mm
065145	Curved blade, 1 x 5 mm

TEMPORARY OCCLUSION CLIPS



065108

ITEM #	DESCRIPTION
065108	7 x 2 mm blade
065109	12 x 2 mm blade



MICRO CLIPS AND APPLIERS

Temporary Vessel Clips

MINI WECK® MICRO VESSEL APPROXIMATOR



065166

ITEM #	DESCRIPTION
065166	5 x 1 mm blades, 7/16" (11 mm) bar

LOUISVILLE MICRO VESSEL APPROXIMATOR WITH CLIPS



065172

With suture staying frame.

ITEM #	DESCRIPTION
065172	1.5 x 8 mm blades, 1/2" (12.5 mm) bar
065173	1 x 5 mm blades, 7/16" (11 mm) bar

MICRO CLIPS AND APPLIERS

Temporary Vessel Clips

WECK® MICRO VESSEL APPROXIMATORS



065170

ITEM #	DESCRIPTION
065165	1.5 x 7.5 mm blades, 1/2" (12.5 mm) bar
065170	1.5 x 7.5 mm blades, 3/4" (19 mm) bar

ULNAR RADIAL APPROXIMATOR



065190

ITEM #	DESCRIPTION
065190	12 x 12 mm blades, 1" (25.5 mm) bar



MICRO CLIPS AND APPLIERS

Temporary Vessel Clips

BRACHIAL LARGE VESSEL APPROXIMATORS



065195

ITEM #	DESCRIPTION
065195	14 mm uniform blades, 1" (25.5 mm) bar
065196	14 mm tapered blades, 1" (25.5 mm) bar

BRACHIAL LARGE VESSEL CLIPS



065110

ITEM #	DESCRIPTION
065110	24 mm straight blade
065111	24 mm tapered blade

VAN BEEK NERVE APPROXIMATORS



065151

ITEM #	DESCRIPTION
065151	For median ulna nerves, 15 mm blade, 1" (25.5 mm) bar, 28 Ga. needles
065152	10 mm blade, 5/8" (16 mm) bar

VASOVASOSTOMY APPROXIMATOR



065181

ITEM #	DESCRIPTION
065181	12 mm blades with serrated 2 mm cups, 3/4" (19 mm) bar

MICRO CLIPS AND APPLIERS

Temporary Vessel Clips

APPROXIMATION CLAMP



KM44030

ITEM #	DESCRIPTION
KM44030	Without suture holding frame, 1/2" (12.5 mm)

MICRO CLAMP APPLICATOR



KM44028

For Approximation Clamp KM44030.

ITEM #	DESCRIPTION
KM44028	5-1/2" (14 cm)

KLEINERT-KUTZ MICRO CLIP APPLYING FORCEPS



065155

ITEM #	DESCRIPTION
065155	2-1/2" (6.5 cm)

RIZZUTI ANGLED MICRO CLIP APPLYING FORCEPS



065175

Applier opens approximator simultaneously or individually.

ITEM #	DESCRIPTION
065175	5-1/2" (14 cm)

MICRO CLIPS AND APPLIERS

Temporary Vessel Clips

MICHEL SKIN CLIPS



151228

ITEM #	DESCRIPTION
151222	11 mm, nickel silver, package of 100
151228	18 mm, nickel silver, package of 100

MICHEL CLIP APPLYING FORCEPS



KM42254

ITEM #	DESCRIPTION
KM42254	5" (12.5 cm)

RICHTER HEATH CLIP FORCEPS

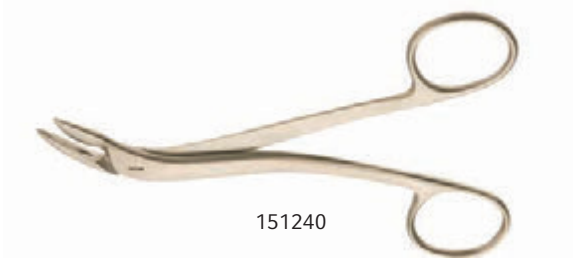

151240

Removing forceps.

ITEM #	DESCRIPTION
151240	5-1/2" (14 cm)

MICHEL CLIP FORCEPS



151210

Applying and removing forceps.

ITEM #	DESCRIPTION
151210	4-3/4" (12 cm)

MICRO CLIPS AND APPLIERS

Temporary Vessel Clips

WACHENFELDT CLIP APPLYING AND REMOVING FORCEPS



KM42256

ITEM #	DESCRIPTION
KM42256	5" (12.5 cm)
KM42258	Cross-action, 5" (12.5 cm)



KM42258

MICRO CLAMP CASE



KM44031

ITEM #	DESCRIPTION
KM44031	2-3/4" x 1-3/4" x 3/8" (70 x 44 x 9.5 mm)

MICRO CLIP STERILIZING TRAY



065199

ITEM #	DESCRIPTION
065199	1-3/4" x 2-3/4" x 1/2" (4.5 x 7 x 1.5 cm)

INSTRUMENT ACCESSORIES

Containers and Trays

1 MM FINE PERFORATED CASES



087702

ITEM #	DESCRIPTION
087702	Micro perforated utility case with sliding micro perforated lid, 3-1/2" x 3-1/2" x 3/4"

ALUMINUM UTILITY CASES



087750

Case includes lid and ultrasoft, silicon mat. Five-year warranty against defects in materials and workmanship.

ITEM #	DESCRIPTION
087747	4" x 8" x 3/4"
087748	8-1/4" x 12-1/4" x 1"
087749	8" x 14" x 1"
087750	10" x 6" x 1"



INSTRUMENT ACCESSORIES

Containers and Trays

MICRO INSTRUMENT TRAYS



429601

Nylon coated and autoclavable. Stainless steel, with silicone racks. Perforated on top and bottom.

ITEM #	DESCRIPTION
429594	Color coded blue, 8" x 12-1/2" (20.5 x 31.5 cm)
429601	Color coded red, 10-1/2" x 15" (26.5 x 38 cm)

DILATOR INSTRUMENT TRAYS



355286



355291

ITEM #	DESCRIPTION
355286	DeBakey® Dilator Tray for 355285 (page 769), tray only, small, 5-3/4" x 9-1/4" x 3/4", holds 12 dilators
355291	DeBakey® Dilator Tray for 355290 (page 769), tray only, large, 5-3/4" x 16-3/4" x 3/4", holds 12 dilators

INSTRUMENT ACCESSORIES

Containers and Trays

POLYSULFONE STERILIZATION TRAYS



508002



508004

Polysulfone with lid. With silicone finger mat.

ITEM #	DESCRIPTION
508002	9-1/2" x 5-1/2" x 2-1/2" (24 x 14 x 6.5 cm)
508004	9" x 13" x 1-3/4" (23 x 33 x 4.5 cm)
521185	11" x 7" x 2" (28 x 18 x 5 cm)
521186	10-3/4" x 12-3/4" (27.5 x 32.5 cm)
521187	10-1/4" x 19-3/4" (26 x 50 cm)



521185

FLASH TRAYS



806024

ITEM #	DESCRIPTION
806024	10" x 6-1/2" x 2-1/2" (25.5 x 16.5 x 6.5 cm)
806098	9" x 5" x 2" (23 x 12.5 x 5 cm)

SAFETY HANDLE



806026

Use with Flash Trays, 806024 and 806098.

ITEM #	DESCRIPTION
806026	10-1/8" (25.5 cm)

INSTRUMENT ACCESSORIES

Containers and Trays

STERILIZATION TRAYS

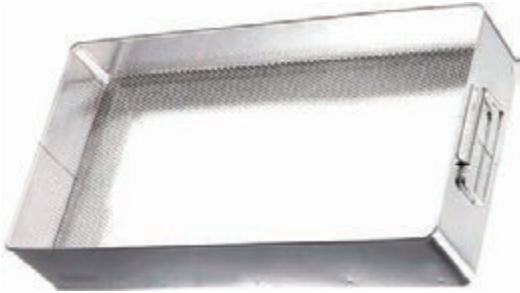

850360

Trays with handles and perforated bottoms.

ITEM #	DESCRIPTION
850350	10-3/8" x 10" x 3" (26.3 x 25.4 x 7.6 cm)
850355	10-3/8" x 15" x 3" (26.3 x 38.1 x 7.6 cm)
850360	10-3/8" x 20" x 3" (26.3 x 50.8 x 7.6 cm)
101050	10" x 6-1/2" x 2-1/2" (25.5 x 16.5 x 6.5 cm), mesh bottom
101054	13" x 20-1/4" x 3-1/2" (33 x 51.5 x 9 cm), mesh bottom
101061	9-1/4" x 6-1/2" x 3/4" (23.5 x 16.5 x 2 cm), perforated bottom

REPLACEMENT TRAY HANDLE



850345

ITEM #	DESCRIPTION
850345	Replacement handle for use with Weck® Special Trays (850325, 850330, 850340)

MULTIPURPOSE STAINLESS STEEL TRAYS



806040

Removable locking lid stores easily under tray during use.

ITEM #	DESCRIPTION
806034	Stainless steel sterilizing tray with lid, 3-1/4" x 7" x 1-3/4" (8.5 x 18 x 4.5 cm)
806040	Stainless steel sterilizing tray with lid, 6" x 30" x 3-1/2"
806048	Stainless steel sterilizing tray with lid, 15" x 10-1/2" x 3-1/2"
806050	Stainless steel sterilizing tray with lid, 20" x 10-1/2" x 3-1/2"
806052	Stainless steel sterilizing tray with lid, 20-1/4" x 13" x 3-1/2"

INSTRUMENT ACCESSORIES

Containers and Trays

INSTRUMENT STERILIZATION TRAY



101075

This stainless steel tray is designed to accommodate all of the component parts of our Wishbone, Bariatric, Poly-Tract Full Abdominal or Upper Abdominal Retractor Systems, or a set or two of our bougies.

ITEM #	DESCRIPTION
101075	Includes lid, 32" x 7" x 7" (81 x 18 x 18 cm)

HIGH MAYO PERFORATED TRAYS



806070

ITEM #	DESCRIPTION
806068	9" x 5" x 1-3/4" (23 x 12.5 x 4.5 cm)
806070	10" x 6-1/2" x 2" (25.5 x 16.5 x 5 cm)
806072	12-3/4" x 10-1/2" x 2-3/4" (31.5 x 26.5 x 7 cm)
806074	12-1/4" x 7-3/4" x 2" (31 x 19.5 x 5 cm)
806076	16-1/2" x 10" x 2-1/2" (42 x 25.5 x 6.5 cm)
806078	20 3/4" x 12-3/4" x 2-1/2" (52.5 x 32.5 x 6.5 cm)

INSTRUMENT TRAYS



960364

ITEM #	DESCRIPTION
960364	12-1/4" x 7-3/4" x 2" (31 x 19.5 x 5 cm)

MAYO TRAYS



471210

Solid bottom.

ITEM #	DESCRIPTION
471185	Tray 9" x 5" x 2" (23 x 12.5 x 5 cm)
471210	Tray 15-1/8" x 10-1/2" x 5/8" (38.5 x 26.5 x 1.5 cm)
471175	Tray 16-1/2" x 10" x 2-1/2" (42 x 25.5 x 6.5 cm)
471215	Tray 17-1/8" x 11-5/8" x 5/8" (43.5 x 29.5 x 1.5 cm)

INSTRUMENT ACCESSORIES

Containers and Trays

PERFORATED MAYO TRAYS



806064

Perforated bottom.

ITEM #	DESCRIPTION
806058	13-3/4" x 9-3/4" x 1/2" (35 x 24.5 x 1 cm)
806060	15" x 10-1/2" x 3/4" (38 x 26.5 x 2 cm)
806062	17" x 11-5/8" x 1/2" (43 x 29.5 x 1 cm)
806064	19" x 12-3/4" x 3/4" (48 x 32.5 x 19 cm)
806066	21-1/4" x 16-1/4" x 3/4" (54 x 41 x 19 cm)

SILICONE MATS



087396

ITEM #	DESCRIPTION
087403	Ultrasoft spike mat, 11" x 11"
087419	Ultrasoft spike mat, 11" x 16"
087420	Ultrasoft spike mat, 11" x 20-1/4"
087396	Ultrasoft spike mat, 11" x 22"
087405	Ultrasoft spike mat, 13" x 20-1/4"
720000M	For Pilling® Laparoscopic Instrument Tray 720000 (page 1149)
720001M	For Pilling® Laparoscopic Instrument Tray 720001 (page 1149)

PATE TRAY POSTS



850310

ITEM #	DESCRIPTION
850310	Special posts to hold instruments in Weck® Special Trays (850325, 850330, 850340), package of a dozen

PILLING® STERILIZATION CASE & TRAY SOLUTIONS

Organize. Protect. Store and Deliver Your Surgical Instruments.

QUALITY & DURABILITY

- Embossed feet will not break, fall off, tear wrap or hang up on wire racks.
- Tough and resilient silicone brackets with stainless steel channel.
- Strong stainless steel latches remain functional for years.
- PVC-coated aluminum provides a smoother “satin-like” finish on all anodized metal parts – instead of a heavy grain finish.

CUSTOMIZABLE WITH SILICONE BRACKETS AND ACCESSORIES

- Customize trays with available accessories to accommodate various instrument geometries.

PROCESSING FUNCTIONALITY

- Maximum holes results in a lighter instrument case.
- Maximum sterilant penetration.
- Improved drainage.

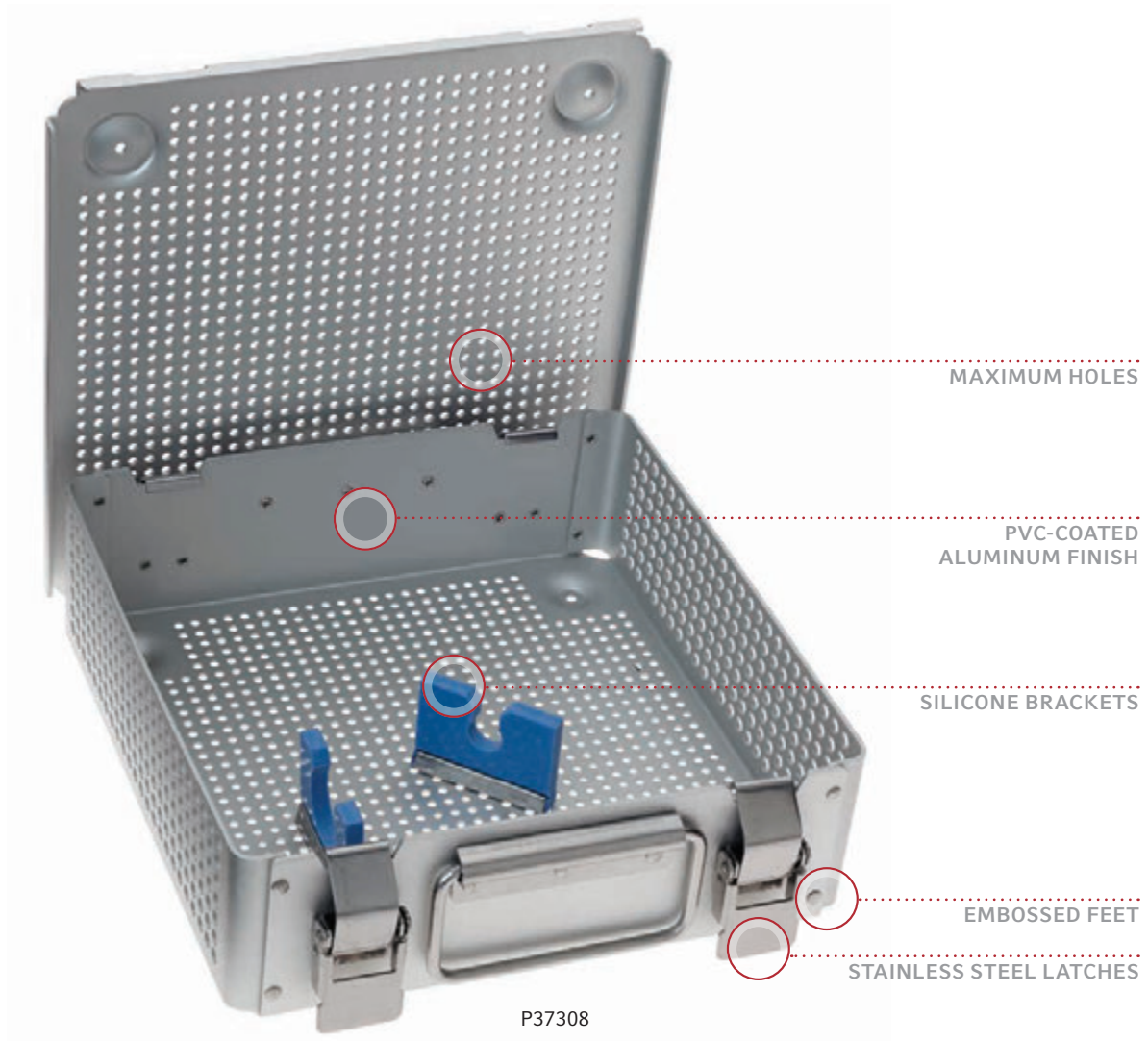

INSTRUMENT ACCESSORIES

Sterilization Case and Tray Solutions

SCOPE CASE

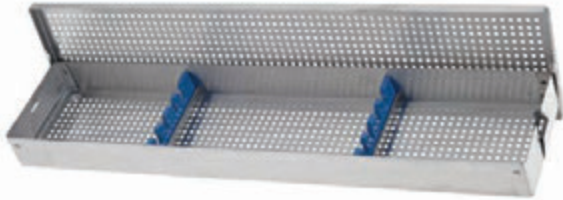

P37314

ITEM #	DESCRIPTION
P37314	For 2 - 4 scopes, with brackets, ext. size: 4" x 17-1/2" x 1-1/2" (10 x 44.5 x 4 cm) int. size: 3.57" x 17.19" x 1.35" (9 x 43.5 x 3.5 cm)

SCOPE CASE



P37319

ITEM #	DESCRIPTION
P37319	For up to 5 scopes/instruments, with brackets, ext. size: 6-1/2" x 31" x 3" (16.5 x 78.5 x 7.5 cm) int. size: 6" x 30" x 2.5" (15 x 76 x 6.5 cm)

SCOPE CASES

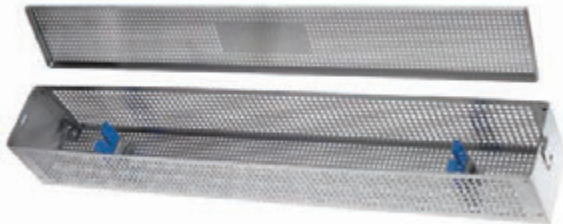

P37318

ITEM #	DESCRIPTION
P37310	Without brackets, ext. size: 3" x 11" x 2-1/2" (7.5 x 28 x 6.5 cm) int. size: 2.93" x 10.93" x 2.5" (7.5 x 28 x 6.5 cm)
P37311	Without brackets, ext. size: 3" x 18" x 2-1/2" int. size: 2.93" x 17.93" x 2.46" (7.5 x 45.5 x 6 cm)
P37318	For single bariatric scope, with brackets, ext. size: 3-1/2" x 26" x 3-1/2" (9 x 66 x 9 cm)
P37312	Two levels, with brackets, and camera and light cord compartments, ext. size: 9" x 20" x 4" (23 x 51 x 10 cm) int. size: 8.47" x 18.68" x 3.55" (21.5 x 47.5 x 9 cm)
P37313	Two levels, without brackets or dividers, ext. size: 9" x 20" x 4" (23 x 51 x 10 cm) int. size: 8.47" x 18.68" x 3.55" (21.5 x 47.5 x 9 cm)

INSTRUMENT ACCESSORIES

Sterilization Case and Tray Solutions

CAMERA AND LIGHT CORD CASES



P37308

ITEM #	DESCRIPTION
P37308	Camera Case, with brackets, ext. size: 9" x 10" x 3" (23 x 25.5 x 7.5 cm) int. size: 8.47" x 8.68" x 2.55" (21.5 x 22 x 6.5 cm)
P37309	Light Cord Case, ext. size: 9" x 9" x 1-1/2" (23 x 23 x 4 cm) int. size: 8.57" x 8.72" x 1.18" (22 x 22 x 3 cm)

FORCEPS CASES



P37327

ITEM #	DESCRIPTION
P37327	Holds up to 8 rongeurs, designed for size 4 & 5 handles with handle guide, ext. size: 9" x 13" x 6" (23 x 33 x 15 cm) int. size: 8.59" x 12.09" x 5.84" (22 x 30.5 x 15 cm)
P37328	For up to 16 arthroscopic and/or sinus forceps interlacing 8 forceps in each direction, ext. size: 9" x 15" x 5" (23 x 38 x 12.5 cm) int. size: 8.59" x 13.84" x 4.84" (22 x 35 x 12.5 cm)

INSTRUMENT ACCESSORIES

Sterilization Case and Tray Solutions

TWO-LEVEL LAP CHOLE CASES



P37316

ITEM #	DESCRIPTION
P37316	With insert and brackets for up to 13-1/2" (35 cm) instruments, ext. size: 11" x 23" x 8" (28 x 58.5 x 20.5 cm) int. size: 10.7" x 21.62" x 7.66" (27 x 55 x 19.5 cm)
P37317	With insert and brackets for up to 26" (65 cm) instruments, ext. size: 11" x 27" x 8" (28 x 68.5 x 20.5 cm) int. size: 10.7" x 25.62" x 7.66" (27 x 65 x 19.5 cm)

LAP CHOLE INSTRUMENT INSERTS

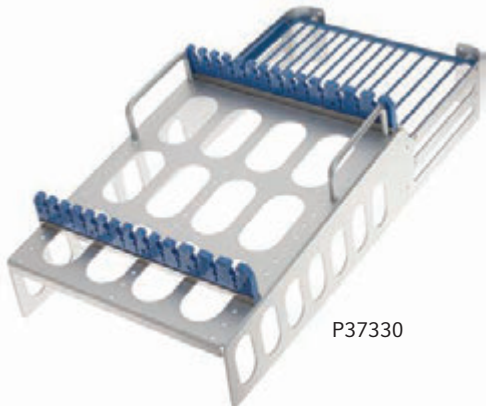

P37330

ITEM #	DESCRIPTION
P37329	Holds 14 instruments, 8" A-type container (fits in a 10" x 20" x 6" container), ext. size: 9-1/2" x 20" x 5-1/2"
P37330	Holds 14 instruments (fits in a 10" x 20" x 6" container), ext. size: 9-1/2" x 20" x 5-1/2"
P37872	Holds 14 instruments (fits in a 10" x 20" x 6" container), ext. size: 9.9" x 19-1/2" x 4.9"



P37872

INSTRUMENT ACCESSORIES

Sterilization Case and Tray Solutions

MICROSURGICAL CASES



P37320



P37324

ITEM #	DESCRIPTION
P37321	Single-level, with pin mat, retainers, ext. size: 10-1/2" x 10-1/2" x 1-1/2" (26.5 x 26.5 x 4 cm) int. size: 9.84" x 10.2" x 1.23" (25 x 26 x 3 cm)
P37322	Single-level, with pin mat, retainers, ext. size: 10-1/2" x 15" x 1-1/2" (26.5 x 38 x 4 cm) int. size: 9.84" x 14.68" x 1.23" (25 x 37.5 x 3 cm)
P37320	Two levels, with pin mat, retainers, ext. size: 10-1/2" x 10-1/2" x 2-1/2" (26.5 x 26.5 x 6.5 cm) int. size: 9.84" x 10.2" x 2.32" (25 x 26 x 6 cm)
P37323	Two levels, with pin mat, retainers, and long tray/half height accessory area, ext. size: 10-1/2" x 15" x 2-1/2" (26.5 x 38 x 6.5 cm) int. size: 9.84" x 14.6" x 2.32" (25 x 37 x 6 cm)
P37325	Two levels, with pin mat, retainers, and long tray/half height accessory area, ext. size: 10-1/2" x 19-1/2" x 2-1/2" (26.5 x 49.5 x 6.5 cm) int. size: 9.84" x 19" x 2.32" (25 x 48.5 x 6 cm)
P37324	Two levels, with pin mat, retainers, and short tray/full height accessory area, ext. size: 10-1/2" x 15" x 2-1/2" (26.5 x 38 x 6.5 cm) int. size: 9.84" x 14.6" x 2.32" (25 x 37 x 6 cm)
P37326	Two levels, with pin mat, retainers, and short tray/full height accessory area, ext. size: 10" x 19-1/2" x 2-1/2" (25.5 x 49.5 x 6.5 cm) int. size: 9.84" x 19" x 2.32" (25 x 48.5 x 6 cm)

OSTEOTOME CASE

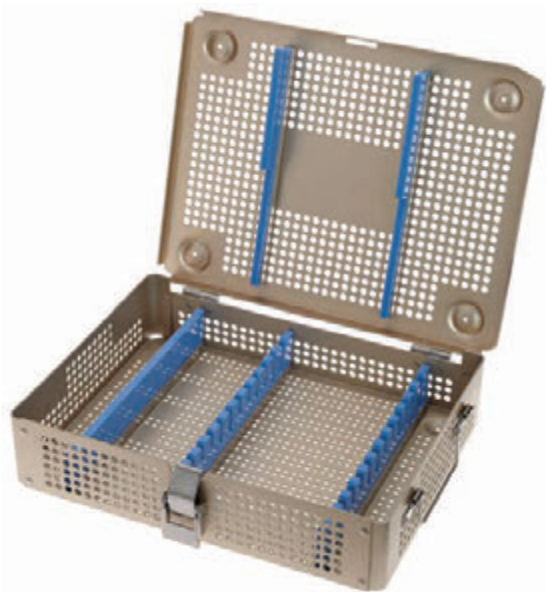

P37335

ITEM #	DESCRIPTION
P37335	For curved and straight Lambottes, ext. size: 9" x 11-1/2" x 3" (23 x 29 x 7.5 cm) int. size: 8.57" x 11.12" x 2.38" (22 x 28 x 6 cm)

INSTRUMENT ACCESSORIES

Sterilization Case and Tray Solutions

SURGICAL CASES AND TRAYS

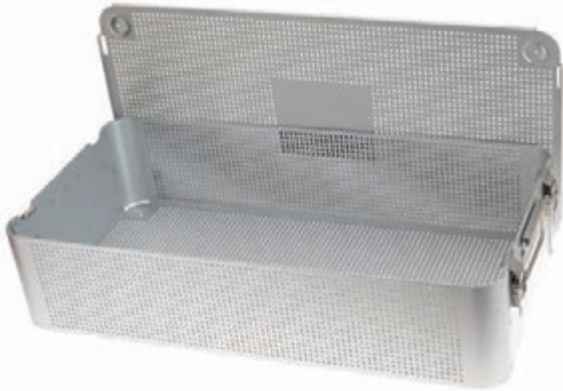

P37332

ITEM #	DESCRIPTION
P37315	Case without brackets or pin mat, ext. size: 10" x 21-1/2" x 2-1/2" (25.5 x 54.5 x 6.5 cm) int. size: 9.72" x 20.65" x 2.42" (24.5 x 52.5 x 6 cm)
P37331	Case without brackets or pin mat, ext. size: 11" x 23" x 3-1/2" (28 x 58.5 x 9 cm) int. size: 10.7" x 21.62" x 3.41" (27 x 55 x 8.5 cm)
P37304	Case without brackets or pin mat, ext. size: 11" x 27" x 3-1/2" (28 x 68.5 x 9 cm) int. size: 10.88" x 25.62" x 3.41" (27.5 x 65 x 8.5 cm)
P37332	Case without optional trays, support brackets, or pin mat, ext. size: 11" x 23" x 5" (28 x 58.5 x 12.5 cm) int. size: 10.7" x 21.62" x 4.91" (27 x 55 x 12.5 cm)
P37333	Case with optional trays and support brackets, without pin mat, ext. size: 11" x 23" x 5" (28 x 58.5 x 12.5 cm) int. size: 10.7" x 21.62" x 4.91" (27 x 55 x 12.5 cm)
P37334	Case with 2 optional trays and support brackets, without pin mat, ext. size: 11" x 23" x 5" (28 x 58.5 x 12.5 cm) int. size: 10.7" x 21.62" x 4.91" (27 x 55 x 12.5 cm)
P37338	Tray, 10-1/2" x 21-1/2" x 2-1/4" (26.5 x 54.5 x 5.5 cm)
P37419	Tray, 10-1/2" x 21-1/2" x 2" (26.5 x 54.5 x 5 cm)

SURGICAL UTILITY CASES

ITEM #	DESCRIPTION
P37336	Ext. size: 5" x 10-1/2" x 2" (12.5 x 26.5 x 5 cm) int. size: 4.5" x 10.29" x 1.63" (11.5 x 26 x 4 cm)
P37337	With full pin mat, center lid retainer, ext. size: 5" x 10-1/2" x 2" (12.5 x 26.5 x 5 cm) int. size: 4.5" x 10.29" x 1.53" (11.5 x 26 x 4 cm)

INSTRUMENT ACCESSORIES

Sterilization Case and Tray Solutions

ACCESSORY BOXES



P37305

ITEM #	DESCRIPTION
P37305	With hardware, ext. size: 1-1/2" x 3-1/2" x 1" (4 x 9 x 2.5 cm) int. size: 1.44" x 3.16" x 1" (3.5 x 8 x 2.5 cm)
P37593	Without hardware, ext. size: 1-1/2" x 3-1/2" x 1" (4 x 9 x 2.5 cm) int. size: 1.44" x 3.16" x 1" (3.5 x 8 x 2.5 cm)

"L" BRACKETS



P37545

ITEM #	DESCRIPTION
P37545	"L" brackets to support trays

INSTRUMENT ACCESSORIES

Sterilization Case and Tray Solutions

SS RISER BRACKET



P37564

ITEM #	DESCRIPTION
P37564	Used to elevate single wide brackets from the case floor, 0.5" x 1.5"

UNIVERSAL BRACKETS



P37339

ITEM #	DESCRIPTION
P37358	5" long, 6 position
P37544	7.5" long, 6 position
P37339	7.5" long, 10 position
P37341	9.25" long, 14 position
P37306	10" long, 15 position

SLOTTED "U" BRACKETS



P37344

ITEM #	DESCRIPTION
P37424	(2 mm) 1.0"
P37346	(3 mm) 1.0"
P37425	(4 mm) 1.0"
P37347	(5 mm) 1.0"
P37426	(6 mm) 1.0"
P37348	(7 mm) 1.0"
P37349	(10 mm) 1.0"
P37350	(12 mm) 1.0"
P37420	(2 mm) 1.5"
P37421	(3 mm) 1.5"
P37342	(4 mm) 1.5"
P37422	(5 mm) 1.5"
P37423	(6 mm) 1.5"
P37343	(7 mm) 1.5"
P37344	(10 mm) 1.5"
P37345	(12 mm) 1.5"

INSTRUMENT ACCESSORIES

Sterilization Case and Tray Solutions

PASS THRU BRACKETS



P37356

ITEM #	DESCRIPTION
P37355	(6 mm) 1.0"
P37429	(7 mm) 1.0"
P37430	(9 mm) 1.0"
P37356	(10 mm) 1.0"
P37357	(12 mm) 1.0"
P37487	(13 mm) 1.0"
P37351	(6 mm) 1.5"
P37352	(7 mm) 1.5"
P37427	(9 mm) 1.5"
P37353	(10 mm) 1.5"
P37354	(12 mm) 1.5"
P37428	(13 mm) 1.5"

KEYHOLE BRACKETS



P37377

ITEM #	DESCRIPTION
P37432	(2 mm) 1.0"
P37433	(3 mm) 1.0"
P37383	(4 mm) 1.0"
P37384	(5 mm) 1.0"
P37486	(6 mm) 1.0"
P37385	(7 mm) 1.0"
P37387	(10 mm) 1.0"
P37388	(12 mm) 1.0"
P37389	(13 mm) 1.0"
P37431	(2 mm) 1.5"
P37372	(3 mm) 1.5"
P37373	(4 mm) 1.5"
P37485	(5 mm) 1.5"
P37374	(6 mm) 1.5"
P37375	(7 mm) 1.5"
P37376	(10 mm) 1.5"
P37377	(12 mm) 1.5"
P37378	(13 mm) 1.5"
P37379	(15 mm) 1.5"
P37380	(19 mm) 1.5"
P37381	(22 mm) 1.5"
P37382	(25 mm) 1.5"
P37390	(3 tier 10/5/3 mm) 1.5"

INSTRUMENT ACCESSORIES

Sterilization Case and Tray Solutions

V-SILICONE RETAINERS



P37361

ITEM #	DESCRIPTION
P37361	9.5"
P37435	14.25"
P37436	18.25"

PIN MATS



P37437

ITEM #	DESCRIPTION
P37437	1" x 4.5"
P37447	1" x 9.63"
P37448	1" x 14.25"
P37449	1" x 18"
P37450	1.5" x 4.5"
P37451	1.5" x 7.13"
P37452	1.5" x 9.12"
P37453	1.5" x 9.63"
P37455	1.5" x 14.25"
P37456	1.5" x 18"
P37457	3.4" x 10.12"
P37391	3.45" x 16.88"
P37454	4.25" x 9.75"
P37392	4.25" x 10.12"
P37401	5" x 10.12"
P37402	5.75" x 10.12"
P37400	6.5" x 10.12"
P37399	6.75" x 10.12"
P37403	6.75" x 17.5"
P37393	8.12" x 8.56"
P37394	8.25" x 18"
P37397	9.5" x 9.5"
P37395	9.63" x 14.13"
P37396	9.63" x 18"
P37398	10.12" x 18"
P37404	13.13" x 18.25"
P37458	Snaps for Pin Mats, 0.187", set of 4

INSTRUMENT ACCESSORIES

Bowls

EMESIS BASINS



471100

ITEM #	DESCRIPTION
471100	8-1/8" x 4-3/8" (20.5 cm x 11 cm)
471105	10" x 5-5/8" (25 cm x 14.5 cm)

MEDICINE CUP



471115

ITEM #	DESCRIPTION
471115	2 oz. (60 mL), 2" diameter x 2" deep (5.1 x 5.1 cm)

IODINE CUP



471120

ITEM #	DESCRIPTION
471120	Holds 6 ounces (177 mL)

SPONGE BOWLS



471135

ITEM #	DESCRIPTION
471125	4-3/4" top diameter x 2" deep (12 x 5 cm), total capacity 12 oz. (360 mL)
471130	5" top diameter x 2-1/4" deep (12.5 x 5.7 cm), total capacity 18 oz. (540 mL)
471135	5-3/4" top diameter x 2-1/2" deep (14.5 x 6.5 cm), total capacity 30 oz. (900 mL)
471140	6-3/8" top diameter x 2-3/4" deep (16 x 7 cm), total capacity 46 oz. (1380 mL)

INSTRUMENT ACCESSORIES

Instrument Holders and Stringers

THOMPSON THORACIC INSTRUMENT HOLDER



343395

This instrument table is easily attached to standard operating table and provides convenient space for instruments in use. This could eliminate the separate and less steady floor-mounted Mayo stand. Complete with Rail Clamps (343393).

ITEM #	DESCRIPTION
343395	

RAIL CLAMPS



343393

ITEM #	DESCRIPTION
343393	1 pair



INSTRUMENT ACCESSORIES

Instrument Holders and Stringers

INSTRUMENT STRINGERS



087531



087550



087561



166870



840200



840210



840221

ITEM #	DESCRIPTION
087531	Posilok single link instrument holder, 8" x 2-3/4"
087532	Posilok single link instrument holder, 10" x 2-3/4"
087533	Posilok single link instrument holder, 12" x 2-3/4"
087550	Instrument stringer, 6"
087552	Instrument stringer, 10"
087559	E-Z lock double lock hinge bar, connects in middle, 8" x 2-3/4"
087561	E-Z lock double lock hinge bar, connects in middle, 12" x 2-3/4"
166868	Lahey instrument holder, 6" (15 cm)
166870	Lahey instrument holder, 8" (20.5 cm)
166872	Lahey instrument holder, 10" (25.5 cm)
166874	Lahey instrument holder, 12" (30.5 cm)
166876	Lahey instrument holder, 14" (35.5 cm)
840200	Worcester instrument holder, 12-5/8" x 4-1/2"
840210	Weinstein instrument holder, 8" x 2-1/2"
840215	Weinstein instrument holder, 10" x 2-1/2"
840221	Instrument holder, 6"
840222	Instrument holder, 12"



INSTRUMENT ACCESSORIES

Instrument Holders and Stringers

INSTRUMENT STRINGER



806122

ITEM #	DESCRIPTION
806122	2-3/4" x 8" (7 x 20.5 cm)

INSTRUMENT HOLDERS



166851

ITEM #	DESCRIPTION
166851	Instrument holder with clasp lock, 8" (20.5 cm)
166853	Instrument holder with clasp lock, 10" (25.5 cm)
166855	Instrument holder with clasp lock, 12" (30.5 cm)
166857	Instrument holder with clasp lock, 14" (35.5 cm)
166859	Instrument holder with clasp lock, 16" (40.5 cm)
166861	Instrument holder with clasp lock, 18" (45.5 cm)

BUNT FORCEPS HOLDER



KM39670

ITEM #	DESCRIPTION
KM39670	

INSTRUMENT ACCESSORIES

Instrument Holders and Stringers

INSTRUMENT RACK



840220

ITEM #	DESCRIPTION
840220	3" (7.5 cm) posts

WECK®-RACKS



840100

Includes 6, 9 or 12 separator clips, 1 security rod, 1 retainer clip.

ITEM #	DESCRIPTION
840100	12-1/8" (31 cm)
840105	15-1/8" (38.5 cm)
840110	18-1/8" (46 cm)

WECK®-RACK RETAINER CLIPS



840116

Replacement retainer clip.

ITEM #	DESCRIPTION
840116	11" (28 cm)
840117	14-3/8" (36.5 cm)
840118	17" (43 cm)

INSTRUMENT ACCESSORIES

Instrument Holders and Stringers

WECK®-RACK SECURITY RODS

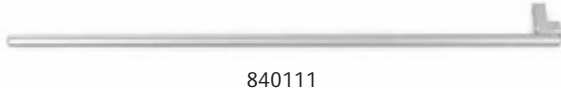

840111

Replacement security rod.

ITEM #	DESCRIPTION
840111	11-3/4" (30 cm)
840112	14-3/4" (37.5 cm)
840113	17-3/4" (45 cm)

WECK®-RACK SEPARATOR CLIPS



840114

Replacement separator clips.

ITEM #	DESCRIPTION
840114	Package of 6

Cleaners and Lubricants

CANNULA CLEANERS



850500

Clean bronchoscopes, laryngoscopes, laparoscopes and suction tubes.

ITEM #	DESCRIPTION
850500	1/8", 50 ft. coil
850502	3/16", 50 ft. coil

INSTRUMENT ACCESSORIES

Cleaners and Lubricants

INSTRUMENT CLEANING BRUSHES



KM39682

ITEM #	DESCRIPTION
KM39682	Wire, set of 3
KM39684	Nylon, set of 3

SCRUB FILES



910110

For use with scrub brush 910100.

ITEM #	DESCRIPTION
910110	For use with scrub brush 910100, 1 dozen

WECK® INSTRUMENT CLEANER



850103

Designed to remove protein on surgical instruments and glassware.

ITEM #	DESCRIPTION
850103	5 lbs.

INSTRUMENT ACCESSORIES

Cleaners and Lubricants

WECK® LIQUID DETERGENT



850110

Concentrate, ideal for ultrasonic cleaners.

ITEM #	DESCRIPTION
850110	1 gallon

WECK-LUBE™



850150

Concentrate. Inhibits rusting of instruments while lubricating.

ITEM #	DESCRIPTION
850150	1 gallon

INSTRUMENT ACCESSORIES

Cleaners and Lubricants

WEC-WASH™



850115

ITEM #	DESCRIPTION
850115	1/2 gallon

WECK® WIPE



200550

Used to clean instruments in the sterile field.

ITEM #	DESCRIPTION
200550	3-1/4" x 3-1/4" (8.5 cm x 8.5 cm), X-ray detectable, sterile, 20 per box, 1 per pouch

INSTRUMENT ACCESSORIES

Cleaners and Lubricants

WEC-KLEEN™



850102

Super concentrate instrument cleaner.

ITEM #	DESCRIPTION
850102	Plastic tub of 2-1/2 lbs.

WEC-KREEM™



850155

Super concentrate instrument lubricant.

ITEM #	DESCRIPTION
850155	1/2 gallon



INSTRUMENT ACCESSORIES

Miscellaneous

MAGNETIC INSTRUMENT MATS



151350

Magna-Tronce is a flexible sheet of silicone with permanent magnets embedded in the sheet. The Magna-Tronce Mat is designed to keep delicate surgical instruments firmly and safely in place, even during the most critical operations. Embedded magnets hold surgical instruments in convenient positions, and eliminate most of the dropped instrument, re-sterilization problems. Flexible Magna-Tronce Mat may be clamped to drapes on any slanted or uneven surface. Grommets are provided at the corners so that the magnetic sheet may be tied or clamped in any position. Magna-Tronce Mat is capable of being autoclaved for sterilization. A film of silicone protects embedded magnets. 11-7/8" x 11-7/8" (30 cm x 30 cm)

ITEM #	DESCRIPTION
151350	Magna-Tronce Mat, single
151351	Magna-Tronce Mat, set of 3

SURG-I-BAND® TAPE



121384

Available in spools 244" x 1/4" (620 x 0.6 cm). Surg-i-Band® Tape is a registered trademark of Scanlan International, Inc.

ITEM #	DESCRIPTION
121380	Surg-i-Band® Tape, Black
121381	Surg-i-Band® Tape, Red
121382	Surg-i-Band® Tape, Green
121383	Surg-i-Band® Tape, Yellow
121384	Surg-i-Band® Tape, Blue
121385	Surg-i-Band® Tape, White
121386	Surg-i-Band® Tape, Orange
121387	Surg-i-Band® Tape, Brown
121388	Surg-i-Band® Tape, Purple
121389	Surg-i-Band® Tape, Neon Orange
121390	Surg-i-Band® Tape, Gray
121391	Surg-i-Band® Tape, Lime Green

FLOOR GRADE INSTRUMENTS

Forceps

IN-EX ADSON DRESSING FORCEPS



101149

ITEM #	DESCRIPTION
101149	Serrated, 4-3/4" (12 cm), 12 per box

IN-EX ADSON TISSUE FORCEPS



101150

ITEM #	DESCRIPTION
101150	1 x 2 teeth, 4-3/4" (12 cm), 12 per box

IN-EX THUMB FORCEPS



101148

ITEM #	DESCRIPTION
101147	Serrated, 5-1/2" (14 cm), 12 per box
101148	1 x 2, 5-1/2" (14 cm), 12 per box



FLOOR GRADE INSTRUMENTS

Forceps

IN-EX BACKHAUS TOWEL CLAMPS



ITEM #	DESCRIPTION
101022	3-1/2" (9 cm), 12 per box
101023	5-1/4" (13.5 cm), 12 per box

IN-EX EDNA TOWEL CLAMP



ITEM #	DESCRIPTION
101028	5-3/8" (13.5 cm), 12 per box

IN-EX HOFF TOWEL CLAMP

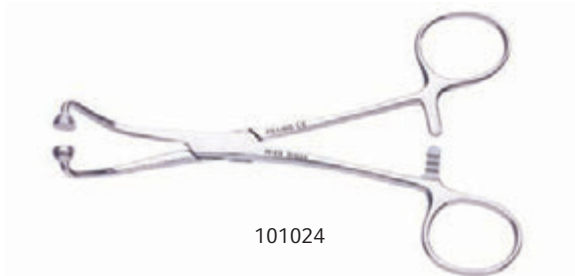

ITEM #	DESCRIPTION
101024	Non-perforating, 5-3/4" (14.5 cm), 12 per box

FLOOR GRADE INSTRUMENTS

Forceps

IN-EX SPONGE FORCEPS

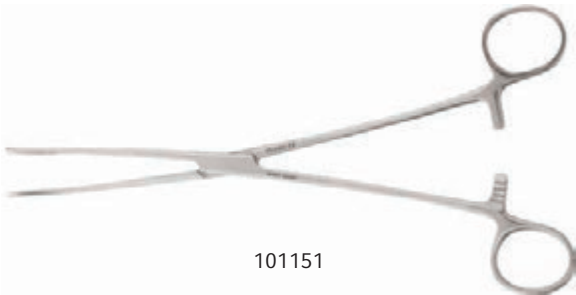

ITEM #	DESCRIPTION
101152	Ballenger, serrated, 7-1/4" (18.5 cm), 12 per box
101151	Foerster, serrated, 9-3/4" (25 cm), 12 per box

IN-EX HALSTED MOSQUITO FORCEPS



ITEM #	DESCRIPTION
101010	Straight, 5" (12.5 cm), 12 per box
101011	Curved, 5" (12.5 cm), 12 per box

IN-EX CRILE FORCEPS



ITEM #	DESCRIPTION
101016	Straight, 5-1/2" (14 cm), 12 per box
101017	Curved, 5-1/2" (14 cm), 12 per box



FLOOR GRADE INSTRUMENTS

Forceps

IN-EX KELLY FORCEPS

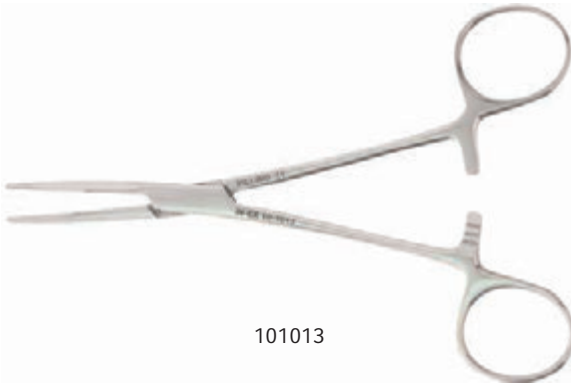

ITEM #	DESCRIPTION
101012	Straight, 5-1/2" (14 cm), 12 per box
101013	Curved, 5-1/2" (14 cm), 12 per box

IN-EX ROCHESTER-PEAN FORCEPS

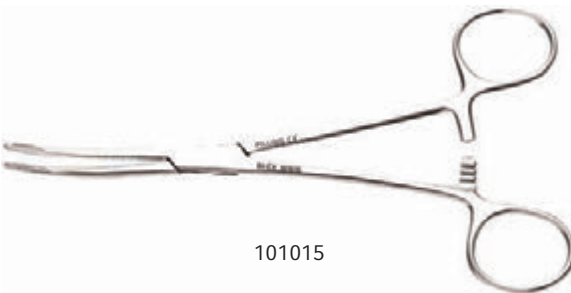

ITEM #	DESCRIPTION
101014	Straight, 6-1/2" (16.5 cm), 12 per box
101015	Curved, 6-1/2" (16.5 cm), 12 per box

IN-EX ALLIS TISSUE FORCEPS

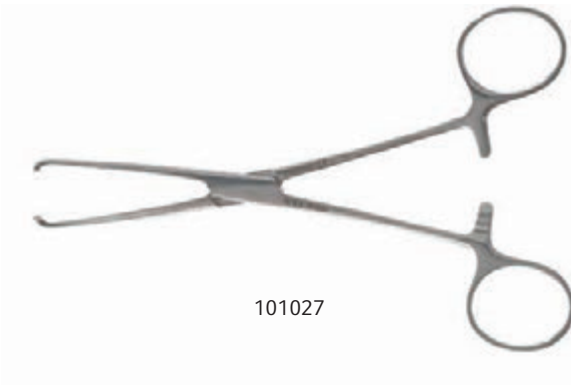

ITEM #	DESCRIPTION
101027	4 x 5 teeth, 6-1/4" (16 cm), 12 per box

FLOOR GRADE INSTRUMENTS

Forceps

IN-EX BOZEMAN UTERINE DRESSING FORCEPS



ITEM #	DESCRIPTION
101033	Straight, 10" (25.5 cm)
101034	Curved, 10-3/8" (26.5 cm)

101033

Needle Holders

IN-EX BAUMGARTNER NEEDLE HOLDER

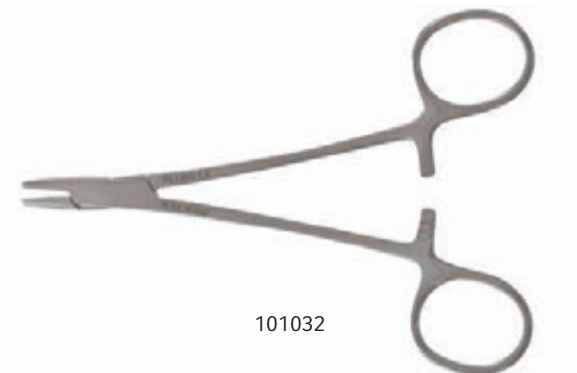

ITEM #	DESCRIPTION
101032	12.5 x 2.7 mm jaw, 5-1/2" (14 cm), 12 per box

101032

IN-EX WEBSTER NEEDLE HOLDER



ITEM #	DESCRIPTION
101031	15.5 x 1.7 mm smooth jaw, 5" (12.5 cm), 12 per box

101031



FLOOR GRADE INSTRUMENTS

Needle Holders

IN-EX MAYO HEGAR NEEDLE HOLDERS

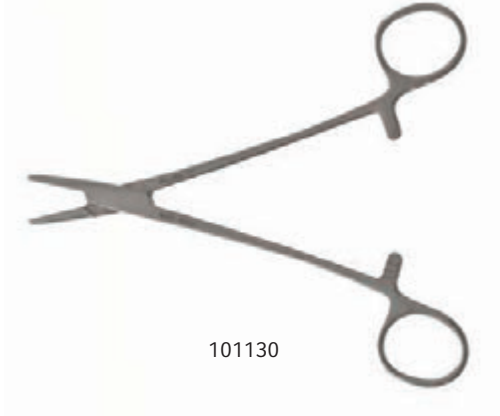

ITEM #	DESCRIPTION
101130	20 x 2.8 mm jaw, 6-1/2" (16.5 cm), 12 per box
101131	24 x 3 mm jaw, 8" (20.5 cm), 12 per box

Scissors

IN-EX LISTER BANDAGE SCISSORS



ITEM #	DESCRIPTION
101142	5-3/4" (14.5 cm), 12 per box
101143	7-1/4" (18.5 cm), 12 per box

IN-EX LITTAUER SUTURE SCISSORS



ITEM #	DESCRIPTION
101146	5-1/2" (14 cm), 12 per box

FLOOR GRADE INSTRUMENTS

Scissors

IN-EX WIRE SCISSORS



101039

ITEM #	DESCRIPTION
101039	4-3/4" (12 cm), 12 per box

IN-EX IRIS SCISSORS



101145

Sharp/Sharp.

ITEM #	DESCRIPTION
101144	Straight, 4-1/2" (11.5 cm), 12 per box
101145	Curved, 4-1/2" (11.5 cm), 12 per box

IN-EX OPERATING SCISSORS

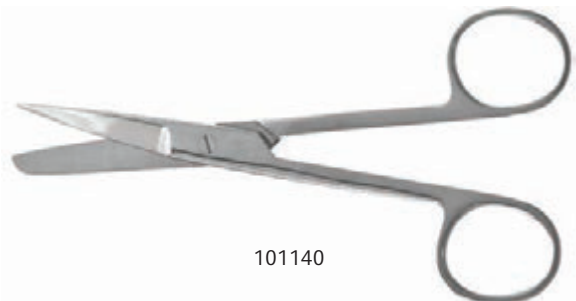

101140

ITEM #	DESCRIPTION
101140	Straight, Sharp/Blunt, 5-1/2" (14 cm), 12 per box
101141	Straight, Sharp/Sharp, 5-1/2" (14 cm), 12 per box



FLOOR GRADE INSTRUMENTS

Scissors

IN-EX MAYO SCISSORS



ITEM #	DESCRIPTION
101035	Straight, 5-1/2" (14 cm), 12 per box
101036	Curved, 5-1/2" (14 cm), 12 per box
101037	Straight, 6-3/4" (17 cm), 12 per box
101038	Curved, 6-3/4" (17 cm), 12 per box

SPECIALTY SPONGES

Specialty Sponges

CYLINDRICAL SPONGES

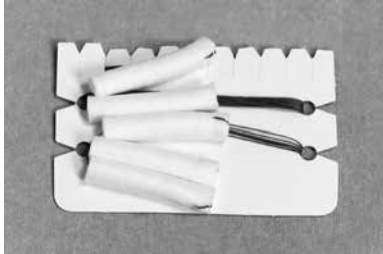

200400



200401

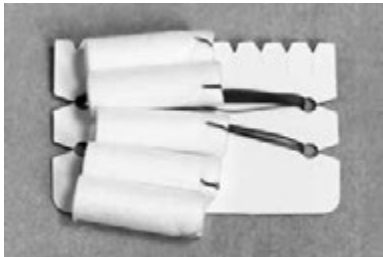

200402

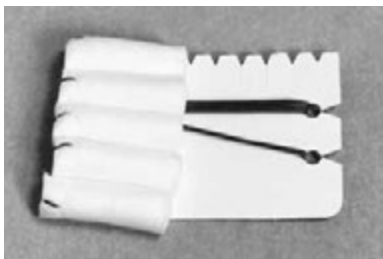

200403

Cylindrical sponges are used during neuro, tonsil, adenoid and nasal surgical procedures for packing and applying medication following surgery and for control of hemorrhaging or drainage. They are similar to the "Rhode Island Sponge."

ITEM #	DESCRIPTION
200400	3/8" x 1-1/2" (9.53 x 38.1 mm) Non X-ray detectable Sterile, end strung, cotton roll 100 per box, 5 per accountability card
200401	3/8" x 1-1/2" (9.53 x 38.1 mm) Non X-ray detectable Sterile, center strung, cotton roll 100 per box, 5 per accountability card
200402	1/2" x 1-1/2" (12.7 mm x 38.1 mm) Non X-ray detectable Sterile, end strung, cotton roll 100 per box, 5 per accountability card
200403	1/2" x 1-1/2" (12.7 x 38.1 mm) Non X-ray detectable Sterile, center strung, cotton roll 100 per box, 5 per accountability card



SPECIALTY SPONGES

Specialty Sponges

GAUZE FLAT SPONGES

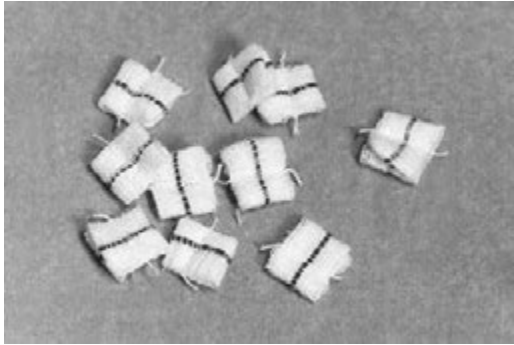

200220

Some flat gauze sponges are used for dissection and absorption, some for absorption only. Those larger sponges used for absorption can be used with sponge forceps.

ITEM #	DESCRIPTION
200220	"Dissectors" 1/2" x 1/2" (12.7 x 12.7 mm) X-ray detectable Sterile, non-strung, cotton gauze 200 per box, 10 per package
200240	Bronchoscopic 1/4" x 3/4" (6.35 x 19 mm) X-ray detectable Sterile, non-strung, cotton 200 per box, 10 per safety pin
200250	2" x 2" (50.8 x 50.8 mm) X-ray detectable Sterile, strung, gauze 200 per box, 10 per accountability card



200240

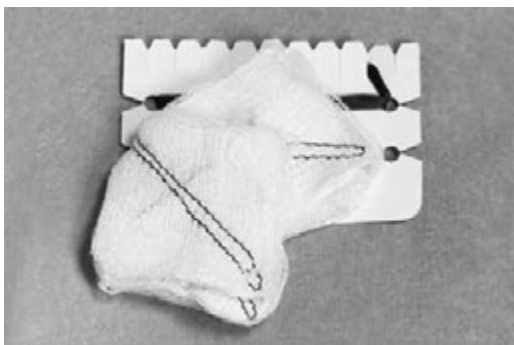

200250

SPECIALTY SPONGES

Specialty Sponges

"K" DISSECTOR SPONGES



200200

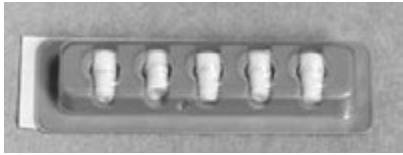

200202



200203



200211

"K" Dissector sponges, named for Dr. Kittner, are held in the jaws of a clamp at the ends or sides of the "can" construction, to provide a stable, soft tip for dissection and absorption during delicate surgical procedures. They have a slightly tighter structure than peanut sponge. Pilling® Dissector Sponges have a tightly-woven chevron mesh for finer dissection, and feature an X-ray thread wound concentrically in layers for X-ray visibility in any direction.

ITEM #	DESCRIPTION
200200	1/4" x 9/16" (6.35 x 14.29 mm) X-ray detectable Sterile, non-strung, cotton gauze 200 per box, 5 per tray
200201	1/4" x 9/16" (6.35 x 14.29 mm) X-ray detectable Sterile, non-strung, cotton gauze 200 per box, 10 per tray
200202	1/4" x 9/16" (6.35 x 14.29 mm) X-ray detectable Sterile, non-strung, cotton gauze 200 per box, 5 per plastic holder
200203	1/4" x 9/16" (6.35 x 14.29 mm) X-ray detectable Sterile, non-strung, cotton gauze 200 per box, 5 per foam holder
200211	1/8" x 9/16" (3.18 x 14.29 mm) X-ray detectable Non-sterile, non-strung, cotton gauze 500 per box, 100 per bag
200212	1/8" x 9/16" (3.18 x 14.29 mm) X-ray detectable Sterile, cotton gauze Box of 40 packages, 5 per package

SPECIALTY SPONGES

Specialty Sponges

LAMINECTOMY WEDGE SPONGES

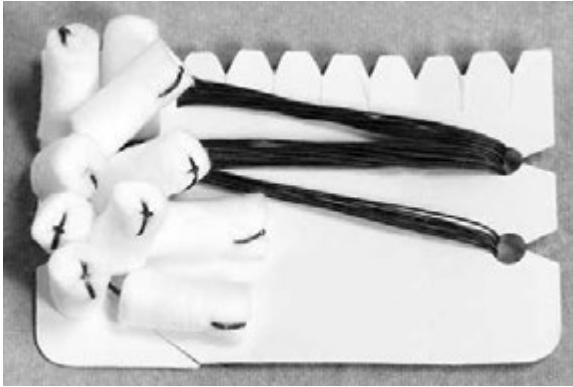

200161

Laminectomy sponges are a type of neuro sponge used to soft tissue in laminectomies.

ITEM #	DESCRIPTION
200161	3/4" x 3/8" (19 x 9.53 mm) Non X-ray detectable Sterile, double-strung, cotton 200 per box, 10 per accountability card

NEURO SPONGES

Neuro sponges are used during cranial and spine surgery to moisten the dura or to cushion against bone edges. They are also used to protect brain tissue under the dura or elsewhere during incision. Gardlok neuro sponges are made from the highest quality non-woven cotton, which is soft, conformable, as free of lint as possible, and highly retentive in comparison to other rayon "cottonoid" brands. For security, the X-ray detectable element is heat sealed and stitched into the sponge, and the sponges are double strung.



200100

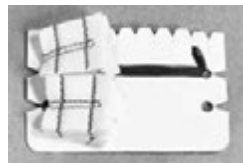

200101

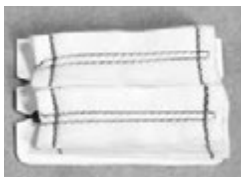

200102



200103

ITEM #	DESCRIPTION
200100	Patties 1/2" x 1/2" (12.7 mm x 12.7 mm) X-ray detectable Sterile, double-strung, cotton 200 per box, 10 per accountability card
200101	Patties 1" x 1" (25.4 mm x 25.4 mm) X-ray detectable Sterile, double-strung, cotton 200 per box, 10 per accountability card
200102	Patties 1" x 3" (25.4 mm x 76.2 mm) X-ray detectable Sterile, double-strung, cotton 200 per box, 10 per accountability card
200103	Patties 1/2" x 1-1/2" (12.7 mm x 38.1 mm) X-ray detectable Sterile, double-strung, cotton 200 per box, 10 per accountability card

SPECIALTY SPONGES

Specialty Sponges



NEURO SPONGES (CONTINUED)

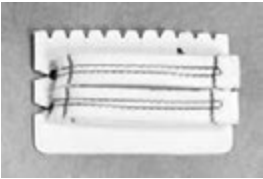

200104

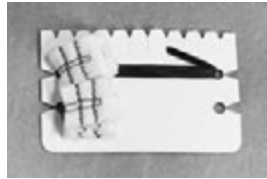

200105

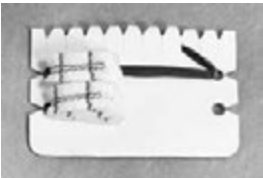

200106



200108



200110

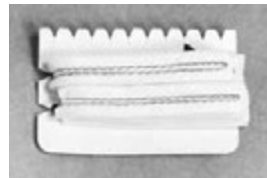

200112

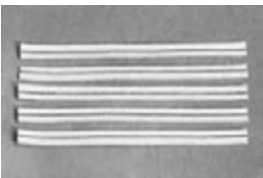

200120

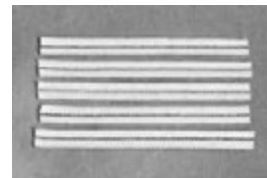

200121



200123

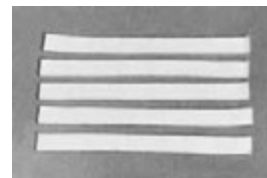

200131

ITEM #	DESCRIPTION
200104	Patties 1/2" x 3" (12.7 mm x 76.2 mm) X-ray detectable Sterile, double-strung, cotton 200 per box, 10 per accountability card
200105	Patties 3/4" x 3/4" (19.5 mm x 19.5 mm) X-ray detectable Sterile, double-strung, cotton 200 per box, 10 per accountability card
200106	Patties 1/2" x 1" (12.7 mm x 25.4 mm) X-ray detectable Sterile, double-strung, cotton 200 per box, 10 per accountability card
200108	Patties 3" x 3" (76.2 mm x 76.2 mm) X-ray detectable Sterile, double-strung, cotton 200 per box, 10 per accountability card
200110	Patties 1/2" x 1/2" (12.7 mm x 12.7 mm) Non X-ray detectable Sterile, double-strung, cotton 200 per box, 10 per accountability card
200112	Patties 1/2" x 3" (12.7 mm x 76.2 mm) Non X-ray detectable Sterile, double-strung, cotton 200 per box, 10 per accountability card
200120	Strips 3/8" x 6" (9.53 mm x 152.4 mm) X-ray detectable Sterile, non-strung, cotton 100 per box, 10 per pouch
200121	Strips 1/2" x 6" (12.7 mm x 152.4 mm) X-ray detectable Sterile, non-strung, cotton 100 per box, 10 per pouch
200123	Strips 1" x 6" (25.4 mm x 152.4 mm) Non X-ray detectable Sterile, non-strung, cotton 100 per box, 10 per pouch
200131	Strips 1/2" x 6" (12.7 mm x 152.4 mm) Non X-ray detectable Sterile, non-strung, cotton 100 per box, 10 per pouch

SPECIALTY SPONGES

Specialty Sponges

PEANUT SPONGES



200214

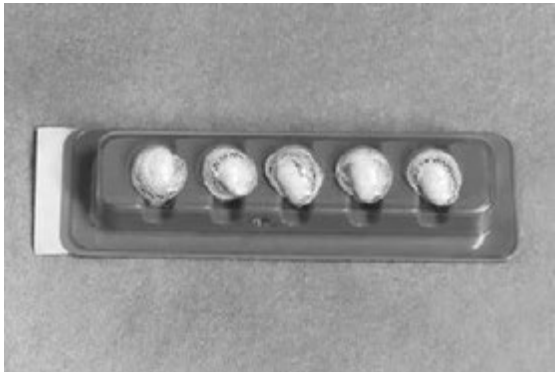

200215



200217

Peanut sponges, held at the end of a hemostat during delicate surgical procedures, facilitate tissue separation around vessels, or identify bleeders, with less chance of damage to those structures. Pilling® Surgical's Gardlok Peanut Sponges are made of USA cotton and feature a large gauze strand for better abrading in blunt dissection.

ITEM #	DESCRIPTION
200214	3/8" (9.53 mm) X-ray detectable Sterile, non-strung, cotton gauze 200 per box, 5 per safety pin
200215	3/8" (9.53 mm) X-ray detectable Sterile, non-strung, cotton gauze 200 per box, 5 per plastic holder
200217	3/8" (9.53 mm) X-ray detectable Sterile, non-strung, cotton gauze 200 per box, 5 per foam holder

SPECIALTY SPONGES

Specialty Sponges

ROSEBUD/CHERRY SPONGES



200218



200230



200231



200232

Smaller versions of peanut sponges, rosebud sponges are used for dissection and absorption where precise dissection is necessary during delicate surgical procedures such as thyroidectomies, colostomy closures, hepatic resections, laryngectomies and abdominal aortic and other vascular procedures. Cherries are very tightly-spun spherical sponges used for very gentle dissection and absorption during delicate surgical procedures. A center hole is incorporated to facilitate grip in a toothed forceps. Gardlok cherry sponges feature an X-ray detectable chip, rather than a tiny monofilament section, in the center of the sponge for enhanced visibility. Cherry sponge construction does not allow for the long monofilament incorporated in other Gardlok dissectors.

ITEM #	DESCRIPTION
200218	Rosebud 1/4" (6.35 mm) X-ray detectable Sterile, non-strung, cotton gauze 200 per box, 5 per foam holder
200230	Rosebud 1/4" (6.35 mm) X-ray detectable Sterile, non-strung, cotton gauze 200 per box, 10 per tray
200231	Rosebud 1/2" (12.7 mm) X-ray detectable Sterile, non-strung, cotton-gauze 200 per box, 10 per tray
200232	Rosebud 1/4" (6.35 mm) X-ray detectable Sterile, non-strung, cotton gauze 200 per box, 5 per plastic holder





SPECIALTY SPONGES

Specialty Sponges

ROSEBUD/CHERRY SPONGES (CONTINUED)



200233

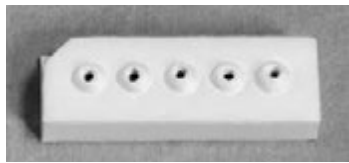

200234



200235



200236

ITEM #	DESCRIPTION
200233	Rosebud 1/2" (12.7 mm) X-ray detectable Sterile, non-strung, cotton gauze 200 per box, 5 per plastic holder
200234	Cherry 3/8" (9.53 mm) X-ray detectable Sterile, non-strung, spun cotton 200 per box, 5 per foam holder
200235	Rosebud 1/4" (6.35 mm) X-ray detectable Sterile, strung, cotton gauze 200 per box, 10 per accountability card
200236	Rosebud 1/2" (12.7 mm) X-ray detectable Sterile, strung, cotton gauze 200 per box, 10 per accountability card

SPECIALTY SPONGES

Specialty Sponges

TONSIL SPONGES

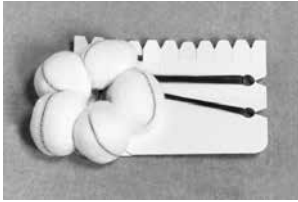

200322

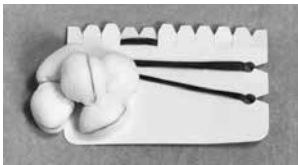

200326



200327

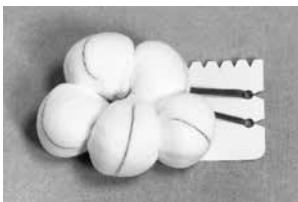

200328

Tonsil sponges are used at the end of a forceps for absorption and pressure hemostatic control during tonsil and adenoid surgery. They can also be drawn into position and tied to a catheter for use after nasal surgical procedures for postnasal or sphenoid packing, applying medication following surgery, and for control of hemorrhaging or drainage. Pilling® Surgical Tonsil Sponges feature double stringing for secure retrieval after use, and are available in a wide variety of choices including gauze, cotton or gauze cotton-filled in three sizes. Other choices include strung or non-strung, X-ray and non X-ray detectable, sterile and non-sterile.

ITEM #	DESCRIPTION
200322	Large X-ray detectable Non-sterile, double-strung, cotton-filled, gauze-covered 1000 per box, 5 per accountability card
200326	Medium X-ray detectable Sterile, double-strung, cotton-filled, gauze-covered 500 per box, 5 per accountability card
200327	Large X-ray detectable Sterile, double-strung, cotton-filled, gauze-covered 500 per box, 5 per accountability card
200328	X-Large X-ray detectable Sterile, double-strung, cotton-filled, gauze-covered 500 per box, 5 per accountability card



SPECIALTY SPONGES

Specialty Sponges

TONSIL SPONGES (CONTINUED)

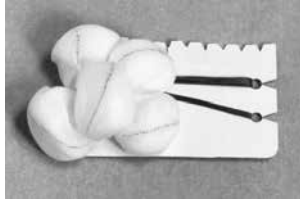

200333

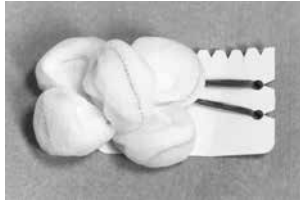

200334

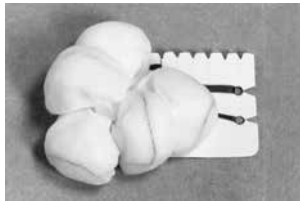

200335

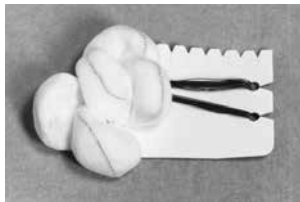

200340

ITEM #	DESCRIPTION
200333	Medium X-ray detectable Sterile, double-strung, gauze-filled, gauze covered 500 per box, 5 per accountability card
200334	Large X-ray detectable Sterile, double-strung, gauze-filled, gauze-covered 500 per box, 5 per accountability card
200335	X-Large X-ray detectable Sterile, double-strung, gauze-filled, gauze-covered 500 per box, 5 per accountability card
200340	Medium. X-ray detectable Sterile, double-strung, gauze-filled, gauze-covered 100 per box, 5 per accountability card

WECK® SPECIALTY PRODUCTS

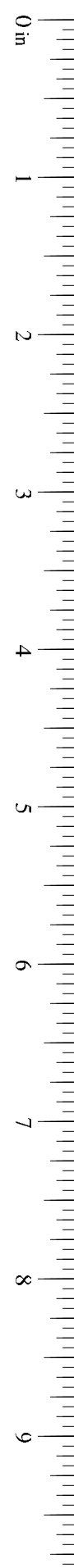

"FISH HOOK" NEURO ELASTIC RETRACTORS



382805

ITEM #	DESCRIPTION
382800	Durahook, 1/4" (6 mm) hook, sterile, single use. 6/pouch, 10 pouches/box
382805	Dermahook, 1/2" (12.5 mm) hook, sterile, single use. 6/pouch, 10 pouches/box

RANEY CLIP APPLYING FORCEPS



658500

ITEM #	DESCRIPTION
658500	Reusable, 6" (15 cm)

RANEY NYLON CLIPS



658505

ITEM #	DESCRIPTION
658505	Sterile, single use, 10/pouch, 20 pouches/box



CONTAINER SYSTEMS

Pilling® Container Systems

NON-PERFORATED CONTAINER BOTTOM



920100



930100



940100

ITEM #	DESCRIPTION
920100	Small 1/2, 285 x 280 x 135 mm
930100	Medium 3/4, 465 x 280 x 135 mm
940100	Large 1/1, 580 x 280 x 135 mm

PERFORATED CONTAINER LID



920200

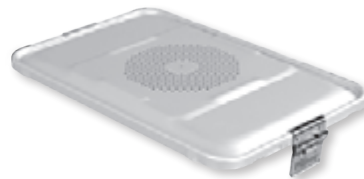

930200



940200

Silver.

ITEM #	DESCRIPTION
920200	Small 1/2, 285 x 280 mm
930200	Medium 3/4, 465 x 280 mm
940200	Large 1/1, 580 x 280 mm

CONTAINER SYSTEMS

Pilling® Container Systems

PERFORATED TRAY WITH FEET

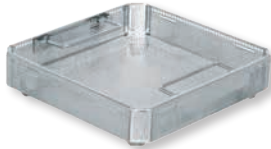

920300



930300



940300

ITEM #	DESCRIPTION
920300	Small 1/2, 242 x 252 x 110 mm
930300	Medium 3/4, 405 x 252 x 110 mm
930301	Medium 3/4, 405 x 252 x 40 mm
940300	Large 1/1, 539 x 252 x 110 mm
940301	Large 1/1, 539 x 252 x 40 mm

PERFORATED SILICONE MAT

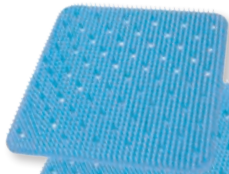

920400



930400



940400

ITEM #	DESCRIPTION
920400	Small 1/2, 225 x 235 mm
930400	Medium 3/4, 370 x 235 mm
940400	Large 1/1, 500 x 235 mm



CONTAINER SYSTEMS

Accessories

CRADLES AND HOLDERS



970002



970003

ITEM #	DESCRIPTION
970002	Cradle for Individual Silicone Holder (bag of 4)
970003	Cradle for 4 Silicone Holders (long)
970010	Silicone Holder 8 x 26 x 40 mm, Open
970020	Silicone Holder 8 x 26 x 40 mm, Closed
970030	Silicone Holder 8 x 26 x 40 mm, Closed Barbed



970010



970020



970030

METAL LABELS



ITEM #	DESCRIPTION
970600	Metal ID Label, Silver
970601	Metal ID Label, Yellow
970602	Metal ID Label, Red
970603	Metal ID Label, Blue
970604	Metal ID Label, Green
970605	Metal ID Label, Black
971000	Metal ID Label, Custom Engrave, Silver*
971001	Metal ID Label, Custom Engrave, Yellow*
971002	Metal ID Label, Custom Engrave, Red*
971003	Metal ID Label, Custom Engrave, Blue*
971004	Metal ID Label, Custom Engrave, Green*
971005	Metal ID Label, Custom Engrave, Black*

*14 characters per line, 2 line maximum



CONTAINER SYSTEMS

Accessories

FILTERS



970700



970701

ITEM #	DESCRIPTION
970700	Filter Holder for S,M,L Paper Filter
970701	Paper Filters 100/pk for S,M,L Container
970702	Paper Filters 500/pk for S,M,L Container

ADDITIONAL ACCESSORIES



970705

ITEM #	DESCRIPTION
970705	Paper Label w/Indicator 250/pk for S,M,L
979000	Plastic Security Seal 100/pk
970040	Extra Cradle Fixation Clips, 4 each
970008	Extra Tray Feet, 4 each
971010	Tray Tag Clips, Metal



979000



970008



970040



971010



WECK® LIGATION SOLUTIONS

Metal and polymer products to help you ligate with security and confidence

From humble beginnings in Edward Weck's Manhattan storefront in 1884, Weck® Branded products have been there for surgeons — step-by-step — since the earliest days of modern surgery.

In 1963, Weck® redefined the closure market with the introduction of the Hemoclip® Traditional Metal Ligating Clip. Over the last fifty years, the Weck® Brand has continued to refine the science of closure to produce a line of metal and polymer ligation solutions demanded by surgeons around the world.

Whether you prefer the classic feel of metal clips, or the modern flexibility of polymer, Teleflex® offers ligation products designed to suit your distinct preferences and procedural needs:

- **Hem-o-lok® Polymer Locking Ligation System** – provides cool ligation, lasting security, and the ability to place and remove clips as needed. Hem-o-lok® Clips are ideal for both open and laparoscopic cases.
- **Horizon™ and Hemoclip® Metal Ligation Systems** – satisfy your need for traditional metal ligating clips for use in cardiovascular and general surgical applications. Available in a range of sizes, surgeons have relied on Weck® Metal Clips for generations.



WECK® LIGATION SOLUTIONS

Weck® Hem-o-lok® Polymer Locking Ligation System

CONFIDENCE YOU CAN FEEL

Confidence. That's what the Weck® Hem-o-lok® Polymer Locking Ligation System provides. Confidence created by a ligation system designed for clip security — secure in the applier, locked onto the patient vessel.

SECURITY BY DESIGN

The Hem-o-lok® Closure System's unique design and flexible hinge keep the clip firmly seated in applier jaws. The clip's distinct tactile feedback confirms jaw seating and secure vessel placement.

COOL LIGATION

Since Hem-o-lok® is a Cool Ligation System, there's no chance of thermal spread to vital structures, a common concern of many surgeons when using energy-based ligation solutions.

SIZE RANGES TO MEET YOUR NEEDS

The Hem-o-lok® System is available in a range of clip sizes: Medium, Medium-Large, Large and Extra-Large. The Hem-o-lok® System allows for ligation of 10 mm vessels through a 5 mm port or 16 mm vessels through a 10 mm port. Our broad range of applier lengths (including 45 cm endoscopic appliers for extended reach) allows surgeons to deliver clips with control and confidence.

HEM-O-LOK® BEHIND THE CLIP

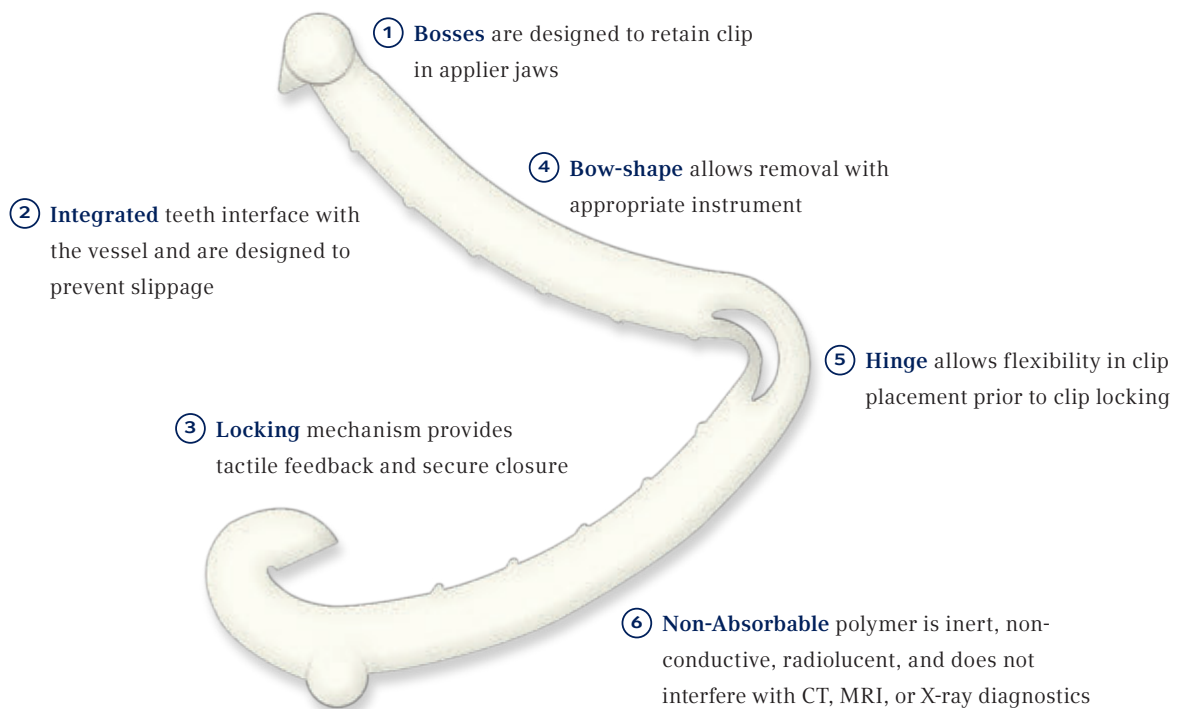

WECK® LIGATION SOLUTIONS

Weck® Hem-o-lok® Polymer Locking Ligation System

MANUAL LOAD APPLIERS

HEM-O-LOK® OPEN APPLIERS

- Open applicators available in Medium, Medium-Large, Large, Extra-Large
- Available in 8" and 11" lengths and curved or right-angle jaws
- Opens at box-lock for easy, thorough cleaning



544180



544179



544240

HEM-O-LOK® ENDOSCOPIC APPLIERS

- Endo applicators available in Medium-Large, Large, Extra-Large
- Medium-Large applicators available on a 5 mm platform
- Available with 32 cm or extended-length 45 cm shafts
- One-piece and take-apart designs



544995T



544965

AUTOMATIC APPLIER

AUTO ENDO5® APPLIER

- 5 mm automatic closure system with 15 Medium-Large clips
- Medium-Large clips designed for 3-10 mm size vessels
- Clip designed for security – locks on to patient vessel

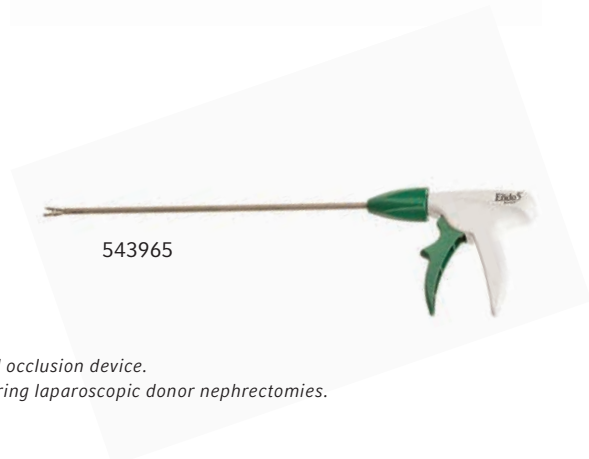

543965

*Hem-o-lok® Ligating Clips are not intended for use as a fallopian contraceptive tubal occlusion device.
Hem-o-lok® Ligating Clips are contraindicated for use in ligating the renal artery during laparoscopic donor nephrectomies.*



WECK® LIGATION SOLUTIONS

Weck® Hem-o-lok® Polymer Locking Ligation System

VESSEL/TISSUE BUNDLE SIZE RANGE

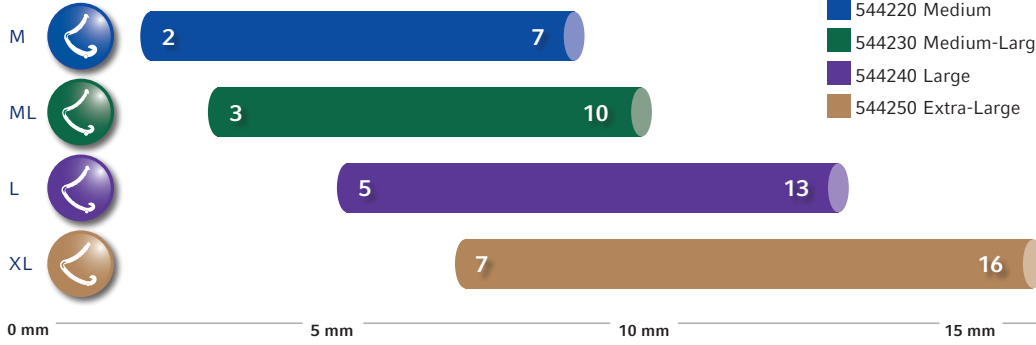

HEM-O-LOK® POLYMER LIGATING CLIPS

- 544220 Medium
- 544230 Medium-Large
- 544240 Large
- 544250 Extra-Large





WECK® LIGATION SOLUTIONS

Weck® Hem-o-lok® Polymer Locking Ligation System

ORDERING INFORMATION

WECK HEM-O-LOK® POLYMER LOCKING LIGATION SYSTEM

CLIPS	OPEN MANUAL LOAD APPLIERS/REMOVERS	ENDOSCOPIC MANUAL LOAD APPLIERS/REMOVERS	AUTOMATIC APPLIERS
 M 544220 Hem-o-lok® Medium Polymer Clips 6 clips/cartridge 14 cartridges per box, sterile	544113 8" Curved 544114 11" Right-Angle (70°) 544115 11" Curved 544123 11" Remover (for M, ML, L)		
 ML 544230 Hem-o-lok® Medium-Large Polymer Clips 6 clips/cartridge 14 cartridges per box, sterile	544170 8" Curved 544171 11" Curved 544172 11" Right-Angle (70°) 544123 11" Remover (for M, ML, L)	Endo5® Applier ML, 5 mm diameter 544965 32.5 cm applier 544965L 45 cm applier 544965T 34 cm applier, take-apart 544121 32 cm remover (for ML and L) 544121L 45 cm remover (for ML and L) 544121T 32 cm remover, take-apart (for ML and L)	543965 Auto Endo5® Applier 15 clips per applier, 3 appliers per box, sterile, disposable for endo surgery
 L 544240 Hem-o-lok® Large Polymer Clips 6 clips/cartridge 14 cartridges per box, sterile	544179 11" Right-Angle (70°) 544180 8" Curved 544181 11" Curved 544182 10" Right-Angle (70°), narrow shaft 544123 11" Remover (for M, ML, L) 544124 11" Remover (for L, XL)	Endo10™ Applier L 544995 32 cm applier, 10 mm 544995L 45 cm applier, 10 mm 544995T 34 cm applier, 10 mm, take-apart 544121 32 cm remover, 5 mm (for ML and L) 544121L 45 cm remover, 5 mm (for ML and L) 544121T 32 cm remover, 5 mm, take-apart (for ML and L) 544130 32 cm remover, 10 mm (for L and XL) 544130L 45 cm remover, 10 mm (for L and XL) 544130T 33 cm remover, 10 mm take-apart (for L and XL)	
 XL 544250 Hem-o-lok® Extra-Large Polymer Clips 6 clips/cartridge 14 cartridges per box, sterile	544191 11" Curved 544192 11" Right-Angle (70°) 544124 11" Remover (for L, XL)	Endo10™ Applier XL, 10 mm diameter 544990 32 cm applier 544990L 45 cm applier 544990T 34 cm applier, take-apart 544130 32 cm remover (for L and XL) 544130L 45 cm remover (for L and XL) 544130T 33 cm remover, take-apart (for L and XL)	
STERILITY STORAGE TRAY		544500 capacity: 3 endoscopic 32 cm appliers P37319 capacity: 2-3 endoscopic 45 cm appliers	

Hem-o-lok® Ligating Clips are not intended for use as a fallopian contraceptive tubal occlusion device.

Hem-o-lok® Ligating Clips are contraindicated for use in ligating the renal artery during laparoscopic donor nephrectomies.

WECK® LIGATION SOLUTIONS

Weck® Hem-o-lok® Polymer Locking Ligation System

The Horizon™ System is the Weck® Premium Titanium Ligation Platform providing surgeons a strong, secure clip coupled with an efficient, convenient easy-load cartridge system.

THE HORIZON™ CLIP

The preformed chevron shape of the Horizon™ Clip engulfs tissue with precise tip-to-tip closure. Heart-shaped wire is designed to give each clip a firm grip on vessels, while the triangulated cross-section of the clip leg maximizes surface-to-surface contact between clip and jaw, practically eliminating clip fallout.

THE HORIZON™ CARTRIDGE

The design of the Horizon™ Cartridge creates a frictionless one-hand load. Horizon™ Cartridges are color-coded to match applicators and adhesive backing allows convenient placement of the cartridge to any sterile area.

Clip images represent approximate, not exact, sizes.



MICROCLIP™



SMALL



MEDIUM



MEDIUM-LARGE



LARGE



WECK® LIGATION SOLUTIONS

Weck® Hem-o-lok® Polymer Locking Ligation System

OPEN APPLIERS

- Available with curved (20°), angled (55°) or right-angled (70°) jaws
- Opens at box-lock for easy, thorough cleaning
- Available in a wide range of applier lengths, including 14"



ENDOSCOPIC APPLIERS

- Medium, Medium-Large and Large
- Extended length available (45 cm shaft)
- Large, lightweight rotation knob allows one-finger, 360° rotation of applier shaft
- Flush ports for thorough cleaning



CLIP OPTIONS

- The Horizon™ Clip Cartridge provides incredibly easy and precise loading that can enhance surgical procedure efficiency
- Both 6- and 24-clip cartridges are available



SPECIALTY APPLIER

- The Horizon™ 11" Multi-Angle Access Open Surgical Applier for small (wide slot) clip cartridges incorporates a 45° angled jaw (or curved jaw) for an optimal angle of access to the surgical target
- The Horizon™ Endosaphenous Vein Applier incorporates a 5 mm shaft diameter with a 7 mm angled jaw for ligation of vein branches



Weck® Ligating Clips are not intended for use as a contraceptive tubal occlusion device.

Weck® Ligating Clips are contraindicated for use in ligating the renal artery during laparoscopic donor nephrectomies.

WECK® LIGATION SOLUTIONS

Weck® Horizon™ Metal Ligation System

ORDERING INFORMATION

WECK® HORIZON™ METAL LIGATION SYSTEM

□ Micro ■ Small ■ Small-Wide ■ Medium ■ Medium-Large ■ Large

TITANIUM LIGATING CLIPS

PRODUCT NUMBER	CLIP SIZE	CLIPS/CARTRIDGE	CARTRIDGES/BOX	CLIPS/BOX
005200	MicroClip™	6	30	180
001200	Small	6	30	180
001204	Small	24	25	600
001201	Small-Wide	6	30	180
001205	Small-Wide	24	25	600
002200	Medium	6	30	180
002204	Medium	24	25	600
003200	Medium-Large	6	20	120
003204	Medium-Large	24	15	360
004200	Large	6	20	120
004204	Large	24	15	360



WECK® LIGATION SOLUTIONS

Weck® Horizon™ Metal Ligation System

WECK® HORIZON™ METAL LIGATION SYSTEM

□ Micro ■ Small ■ Small-Wide ■ Medium ■ Medium-Large ■ Large

OPEN SURGICAL APPLIERS

PRODUCT #	APPLIER LENGTH	CLIP SIZE	JAW TYPE*
537061	6" (15 cm)	MicroClip™	Curved
537081	8" (20 cm)	MicroClip™	Curved
137061	6" (15 cm)	Small	Curved
137081	8" (20 cm)	Small	Curved
137085	8" (20 cm)	Small	Angled
137111	11" (28 cm)	Small	Curved
137062	6" (15 cm)	Small-Wide	Curved
137082	8" (20 cm)	Small-Wide	Curved
137086	8" (20 cm)	Small-Wide	Angled
137112	11" (28 cm)	Small-Wide	Curved
237061	6" (15 cm)	Medium	Curved
237081	8" (20 cm)	Medium	Curved
237085	8" (20 cm)	Medium	Angled
237111	11" (28 cm)	Medium	Curved
237115	11" (28 cm)	Medium	Angled
237117	11" (28 cm)	Medium	Right-Angled
237141	14" (35.5 cm)	Medium	Curved
237145	14" (35.5 cm)	Medium	Angled
337081	8" (20 cm)	Medium-Large	Curved
337085	8" (20 cm)	Medium-Large	Angled
337111	11" (28 cm)	Medium-Large	Curved
337115	11" (28 cm)	Medium-Large	Angled
337117	11" (28 cm)	Medium-Large	Right-Angled
337141	14" (35.5 cm)	Medium-Large	Curved
337145	14" (35.5 cm)	Medium-Large	Angled
437081	8" (20 cm)	Large	Curved
437085	8" (20 cm)	Large	Angled
437111	11" (28 cm)	Large	Curved
437115	11" (28 cm)	Large	Angled
437117	11" (28 cm)	Large	Right-Angled
437141	14" (35.5 cm)	Large	Curved
437145	14" (35.5 cm)	Large	Angled

ENDOSCOPIC LIGATING APPLIERS

PRODUCT #	APPLIER LENGTH	DIAMETER	CLIP SIZE	JAW TYPE
238110	12" (31 cm)	10 mm	Medium	Endoscopic
238170	18" (45 cm)	10 mm	Medium	Endoscopic
238200	13" (32 cm)	5 mm Shaft, 7 mm Jaw	Medium	Endosaphenous
338110	12" (21 cm)	10 mm	Medium-Large	Endoscopic
338170	18" (45 cm)	10 mm	Medium-Large	Endoscopic
438110	14" (36 cm)	12 mm	Large	Endoscopic
438170	18" (45 cm)	12 mm	Large	Endoscopic

ENDOSCOPIC LIGATING APPLIERS – TAKE-APART

PRODUCT #	APPLIER LENGTH	DIAMETER	CLIP SIZE	JAW TYPE
238110T	13" (32 cm)	10 mm	Medium	Endoscopic
338110T	13" (32 cm)	10 mm	Medium-Large	Endoscopic

SPECIALTY OPEN SURGICAL LIGATING APPLIERS

PRODUCT #	APPLIER LENGTH	CLIP SIZE	JAW TYPE
137117	11" (28 cm)	Small-Wide	45° Angled
137118	11" (28 cm)	Small-Wide	Curved

METAL CLIP REMOVERS (REMOVES ALL WECK METAL CLIPS)

PRODUCT #	APPLIER LENGTH	STYLE
523120	6.5" (16.5 cm)	Straight
523121	10.5" (26.7 cm)	Bent Shaft, 30° Angle

Weck® Ligating Clips are not intended for use as a contraceptive tubal occlusion device. Weck® Ligating Clips are contraindicated for use in ligating the renal artery during laparoscopic donor nephrectomies.

**Curved 20°, Angled 55°, Right-Angle 70°*

WECK® LIGATION SOLUTIONS

Weck® Horizon™ Metal Ligation System

HEMOCLIP® TRADITIONAL

The Hemoclip® Traditional Metal Ligating Clips:

- Friction fit loading system
- Available in titanium, tantalum and stainless steel – the widest metal selection in the industry
- Cartridge base to assist loading

HEMOCLIP® PLUS

The Hemoclip® Plus System is an evolution of the classic metal Hemoclip® Hemoclip® Plus Metal Ligating Clips:

- Features an easy-load cartridge system
- Clip loads from the cartridge with minimal pressure
- Available with adhesive or non-adhesive clip cartridges

CLIP OPTIONS

- Chevron shaped clip for precise tip to tip closure
- Heart-shaped wire for tenacious grip on vessels
- Lateral transverse grooves for increased vessel contact



523130

OPEN APPLIERS

- Available in a variety of lengths and tip angles
- Opens at box-lock for easy cleaning



- Curved tip



- Right angle tip

WECK® LIGATION SOLUTIONS

Weck® Horizon™ Metal Ligation System

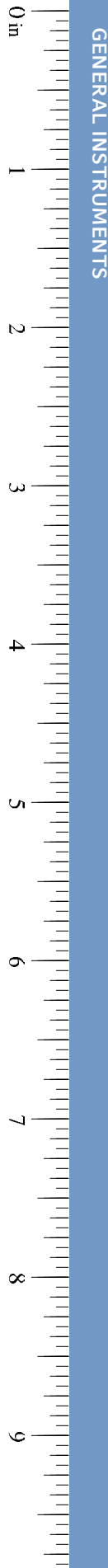

*Weck® Ligating Clips are not intended for use as a contraceptive tubal occlusion device.
Weck® Ligating Clips are contraindicated for use in ligating the renal artery during laparoscopic donor nephrectomies.*

WECK® LIGATION SOLUTIONS

Weck® Horizon™ Metal Ligation System

ORDERING INFORMATION

WECK® HEMOCLIP® TRADITIONAL CLIPS AND APPLIERS

■ Small ■ Medium ■ Medium-Large ■ Large

HEMOCLIP® TRADITIONAL-TITANIUM LIGATING CLIPS

PRODUCT #	CLIP SIZE	CLIPS/ CARTRIDGE	CARTRIDGES/ BOX	CLIPS/BOX
523735	Small	25	12	300
523835	Small	10	24	240
523700	Medium	25	10	250
523800	Medium	10	20	200
523760	Medium-Large	10	20	200
523860	Medium-Large	10	16	160
523770	Large	15	10	150
523870	Large	10	12	120

HEMOCLIP® TRADITIONAL-TANTALUM LIGATING CLIPS

PRODUCT #	CLIP SIZE	CLIPS/ CARTRIDGE	CARTRIDGES/ BOX	CLIPS/BOX
523135	Small	25	12	300
523335	Small	10	24	240
523100	Medium	25	10	250
523300	Medium	10	20	200
523160	Medium-Large	10	20	200
523360	Medium-Large	10	16	160
523170	Large	15	10	150
523370	Large	10	12	120

HEMOCLIP® TRADITIONAL-STAINLESS STEEL LIGATING CLIPS

PRODUCT #	CLIP SIZE	CLIPS/ CARTRIDGE	CARTRIDGES/ BOX	CLIPS/BOX
523435	Small	25	12	300
523635	Small	10	24	240
523400	Medium	25	10	250
523600	Medium	10	20	200
523460	Medium-Large	10	20	200
523660	Medium-Large	10	16	160
523470	Large	15	10	150
523670	Large	10	12	120

HEMOCLIP® TRADITIONAL LIGATING CLIP APPLIERS

PRODUCT #	CLIP SIZE	APPLIER LENGTH	JAW TYPE
523140	Small	6" (15 cm)	Curved
523150	Small	8" (20 cm)	Curved
523151	Small	11" (28 cm)	Curved
523105	Medium	8" (20 cm)	Right Angled
523106	Medium	11" (28 cm)	Right Angled
523109	Medium	6" (15 cm)	Curved
523110	Medium	8" (20 cm)	Curved
523111	Medium	11" (28 cm)	Curved
523165	Medium-Large	8" (20 cm)	Curved
523166	Medium-Large	11" (28 cm)	Curved
523167	Medium-Large	8" (20 cm)	Right Angled
523168	Medium-Large	11" (28 cm)	Right Angled
523175	Large	8" (20 cm)	Curved
523177	Large	8" (20 cm)	Right Angled
523178	Large	11" (28 cm)	Right Angled
523180	Large	11" (28 cm)	Curved

HEMOCLIP® TRADITIONAL LIGATING CLIP PRECISION APPLIERS

PRODUCT #	CLIP SIZE	APPLIER LENGTH	JAW TYPE
523540	Small	6" (15 cm)	Curved
523550	Small	8" (20 cm)	Curved
523551	Small	11" (28 cm)	Curved

HEMOCLIP® LIGATING CLIP ACCESSORIES

PRODUCT #	CLIP SIZE	APPLIER LENGTH	JAW TYPE
523120	Removing Forceps	6" (15 cm)	Straight
523121	Removing Forceps	10" (25.4 cm)	Angled Shanks
523130	Cartridge Base	7" (17.78 cm)	

WECK® LIGATION SOLUTIONS

Weck® Horizon™ Metal Ligation System

WECK® HEMOCLIP® PLUS CLIPS AND APPLIERS

■ Small ■ Small-Strongpoint ■ Medium ■ Medium-Large ■ Large

HEMOCLIP® PLUS TITANIUM LIGATING CLIPS

PRODUCT #	CLIP SIZE	CLIPS/ CARTRIDGE	CARTRIDGES/ BOX	CLIPS/BOX
533735	Small w/tape	25	12	300
533737	Small	25	12	300
533835	Small w/tape	10	18	180
533837	Small	10	18	180
534735	Small-Strongpoint w/tape	25	12	300
534737	Small-Strongpoint	25	12	300
534835	Small-Strongpoint w/tape	10	18	180
534837	Small-Strongpoint	10	18	180
533700	Medium w/tape	25	10	250
533702	Medium	25	10	250
533800	Medium w/tape	10	18	180
533802	Medium	10	18	180
533860	Medium-Large w/tape	10	12	120
533862	Medium-Large	10	12	120
533870	Large w/tape	10	12	120
533872	Large	10	12	120

HEMOCLIP® PLUS LIGATING CLIP APPLIERS

PRODUCT #	CLIP SIZE	APPLIER LENGTH	JAW TYPE
533140	Small	6" (15 cm)	Curved
533150	Small	8" (20 cm)	Curved
533151	Small	11" (28 cm)	Curved
533152	Small	8" (20 cm)	Right Angled
534140	Small-Strongpoint	6" (15 cm)	Curved
534150	Small-Strongpoint	8" (20 cm)	Curved
533105	Medium	8" (20 cm)	Right Angled
533106	Medium	11" (28 cm)	Right Angled
533108	Medium	11" (28 cm)	Angled
533109	Medium	6" (15 cm)	Curved
533110	Medium	8" (20 cm)	Curved
533111	Medium	11" (28 cm)	Curved
533164	Medium-Large	11" (28 cm)	Angled
533165	Medium-Large	8" (20 cm)	Curved
533166	Medium-Large	11" (28 cm)	Curved
533167	Medium-Large	8" (20 cm)	Right Angled
533168	Medium-Large	11" (28 cm)	Right Angled
114527	Medium-Large	13" (32 cm)	Endoscopic
533175	Large	8" (20 cm)	Curved
533177	Large	8" (20 cm)	Right Angled
533178	Large	11" (28 cm)	Right Angled
533180	Large	11" (28 cm)	Curved
533181	Large	11" (28 cm)	Angled

HEMOCLIP® LIGATING CLIP ACCESSORIES

PRODUCT #	CLIP SIZE	APPLIER LENGTH	JAW TYPE
523120	Removing Forceps	6" (15 cm)	Straight
523121	Removing Forceps	10" (25.4 cm)	Angled Shanks
523130	Cartridge Base	7" (17.78 cm)	

Weck® Ligating Clips are not intended for use as a contraceptive tubal occlusion device.

Weck® Ligating Clips are contraindicated for use in ligating the renal artery during laparoscopic donor nephrectomies.